

M100
Self-Propelled Windrower

OPERATOR'S MANUAL

Part #169304 Revision C

\$25

This Manual contains instructions for "SAFETY", "OPERATION", and "MAINTENANCE/SERVICE" for your new MacDon Model M100 Self-Propelled Windrower.



CALIFORNIA

Proposition 65 Warning

Diesel engine exhaust and some of its constituents are known to the State of California to cause cancer, birth defects, and other reproductive harm.

1 INTRODUCTION

This manual contains information on the MacDon Model M100 Self-Propelled Windrower that is designed to cut and lay in windrows, a wide variety of grain, hay and specialty crops. Windrowing allows starting the harvest earlier, protects the crop from wind damage, and gives you more flexibility in scheduling combine time.

The power unit (referred to in this manual as the “windrower”), when coupled with one of the specially designed auger, or draper headers, provides a package which incorporates many features and improvements in design. This manual must be used in conjunction with your Header Operator's Manual.

CAREFULLY READ ALL THE MATERIAL PROVIDED BEFORE ATTEMPTING TO UNLOAD, ASSEMBLE, OR USE THE MACHINE.

Use this manual as your first source of information about the machine. If you follow the instructions given in this manual, your M100 Windrower will work well for many years. If you require more detailed service information, check with your dealer.

Use the Table of Contents and the Index to guide you to specific areas. Study the Table of Contents to familiarize yourself with how the material is organized.

Keep this manual handy for frequent reference and to pass on to new operators or owners. Call your dealer if you need assistance, information, or additional copies of this manual. A manual storage case is provided in the cab.

NOTE: Right-Hand and Left-Hand designations are determined by the operator's position, facing the direction of travel.

RECORD THE SERIAL NUMBERS IN THE SPACES BELOW.

Windrower _____

M100 Diesel Engine _____

Serial Number plate is located on the left side of the main frame, near the rear corner.

Serial Number plate is located on the right side of the engine block.



TABLE OF CONTENTS

Section/Title	Page
1 INTRODUCTION	1
2 SAFETY	5
2.1 SAFETY ALERT SYMBOL	5
2.2 SIGNAL WORDS	5
2.3 SAFETY SIGNS	5
2.3.1 <i>Safety Sign Installation</i>	5
2.3.2 <i>Safety Sign Locations</i>	5
2.4 GENERAL SAFETY	10
3 ACRONYMS AND ABBREVIATIONS	12
4 SPECIFICATIONS	13
4.1 WINDROWER DIMENSIONS	13
4.2 SPECIFICATIONS	14
5 OPERATOR'S STATION	16
5.1 OPERATOR CONSOLE	16
5.2 SEAT ADJUSTMENTS	16
5.3 TRAINING SEAT (Optional)	17
5.4 SEAT BELTS	17
5.5 STEERING COLUMN ADJUSTMENT	17
5.6 OPERATOR PRESENCE	18
5.6.1 <i>Header Drive</i>	18
5.6.2 <i>Transmission</i>	18
5.6.3 <i>Engine</i>	18
5.7 LIGHTS	19
5.7.1 <i>Field Lighting</i>	19
5.7.2 <i>Road Lighting</i>	20
5.7.3 <i>Beacon Lighting – Export</i>	20
5.8 WINDSHIELD WIPERS	21
5.9 REAR VIEW MIRRORS	21
5.10 CAB TEMPERATURE	22
5.10.1 <i>Controls</i>	22
5.10.2 <i>Air Distribution</i>	22
5.10.3 <i>Heater Shut-Off Valve</i>	22
5.10.4 <i>A/C Compressor Protection</i>	23
5.11 INTERIOR LIGHTS	23
5.12 OPERATOR AMENITIES	23
5.13 RADIOS	24
5.13.1 <i>AM/FM Radio</i>	24
5.13.2 <i>Antenna Mounting</i>	24
5.14 HORN	24
5.15 ENGINE CONTROLS/GAUGES	25
5.16 WINDROWER CONTROLS	26
5.17 HEADER CONTROLS	27
5.17.1 <i>Header Engage Switch</i>	27
5.17.2 <i>GSL Header Switches</i>	27
5.17.3 <i>Console Header Switches</i>	29
5.18 CAB DISPLAY MODULE (CDM)	30
5.18.1 <i>Engine and Windrower Functions</i>	30
5.18.2 <i>Header Functions</i>	30
5.18.3 <i>Operating Screens</i>	31
5.18.4 <i>Cab Display Module (CDM) Warnings/Alarms</i>	36
5.18.5 <i>Cab Display Module (CDM) Programming</i>	39
5.18.6 <i>Engine Error Codes</i>	44
5.18.7 <i>CDM & WCM Fault Codes</i>	44
6 OPERATION	45
6.1 OWNER/OPERATOR RESPONSIBILITIES	45
6.2 SYMBOL DEFINITIONS	45
6.2.1 <i>Engine Functions</i>	45
6.2.2 <i>Windrower Operating Symbols</i>	45

TABLE OF CONTENTS

6.2.3	<i>Header Functions</i>	46
6.3	WINDROWER OPERATION	47
6.3.1	<i>Operational Safety</i>	47
6.3.2	<i>Break-In Period</i>	47
6.3.3	<i>Pre-Season Check</i>	48
6.3.4	<i>Daily Check</i>	48
6.3.5	<i>Engine Operation</i>	49
6.3.6	<i>Driving the Windrower</i>	53
6.3.7	<i>Adjustable Caster Tread Width (Optional)</i>	57
6.3.8	<i>Transporting</i>	58
6.3.9	<i>Storage</i>	68
6.4	HEADER OPERATION	69
6.4.1	<i>Header Lift Cylinder Stops</i>	69
6.4.2	<i>Header Flotation</i>	70
6.4.3	<i>Header Drive</i>	73
6.4.4	<i>Header Angle</i>	74
6.4.5	<i>Cutting Height</i>	75
6.5	D SERIES HEADER OPERATION	77
6.5.1	<i>Header Attachments</i>	77
6.5.2	<i>Header Detachment</i>	80
6.5.3	<i>Header Position Adjustments</i>	82
6.5.4	<i>Reel Fore-Aft Position (Optional)</i>	82
6.5.5	<i>Reel Height</i>	82
6.5.6	<i>Reel Speed</i>	83
6.5.7	<i>Draper Speed</i>	85
6.5.8	<i>Knife Speed</i>	87
6.5.9	<i>Deck Shift (Optional)</i>	88
6.6	A SERIES HEADER OPERATION	89
6.6.1	<i>Header Attachment – A Series</i>	89
6.6.2	<i>Header Detachment</i>	92
6.6.3	<i>Auger Speed</i>	94
6.6.4	<i>Reel Speed</i>	95
6.6.5	<i>Knife Speed</i>	96
7	MAINTENANCE/SERVICE	98
7.1	PREPARATION FOR SERVICING	98
7.1.1	<i>Welding Precautions</i>	98
7.2	RECOMMENDED SAFETY PROCEDURES	98
7.3	MAINTENANCE SPECIFICATIONS	99
7.3.1	<i>Recommended Fluids, Fuel, and Lubricants</i>	99
7.3.2	<i>Recommended Torques</i>	100
7.3.3	<i>Conversion Chart</i>	102
7.4	ENGINE COMPARTMENT HOOD	103
7.5	MAINTENANCE PLATFORM	104
7.5.1	<i>Opening/Closing Platform</i>	104
7.5.2	<i>Opening/Closing Platform for Major Servicing</i>	104
7.6	LUBRICATING THE WINDROWER	105
7.6.1	<i>Procedure</i>	105
7.6.2	<i>Lubrication Points</i>	106
7.7	OPERATOR'S STATION	107
7.7.1	<i>Seat Belts</i>	107
7.7.2	<i>Safety Systems</i>	107
7.7.3	<i>Traction Drive Adjustments</i>	108
7.7.4	<i>Neutral Set-Up Procedure</i>	113
7.7.5	<i>HVAC System</i>	115
7.8	ENGINE	118
7.8.1	<i>General Engine Inspection</i>	118
7.8.2	<i>Oil Level</i>	118
7.8.3	<i>Changing Oil and Oil Filter</i>	119
7.8.4	<i>Air Intake System</i>	120
7.8.5	<i>Fuel System</i>	123
7.8.6	<i>Engine Cooling System</i>	128
7.8.7	<i>Exhaust System</i>	131
7.8.8	<i>Belts</i>	132

TABLE OF CONTENTS

7.8.9	<i>Engine Speed</i>	133
7.9	COOLING BOX	134
7.9.1	<i>Cooling Box Screen Cleaners</i>	134
7.9.2	<i>Cooling Box Maintenance</i>	136
7.10	ELECTRICAL SYSTEM	138
7.10.1	<i>Battery</i>	138
7.10.2	<i>Headlights</i>	143
7.10.3	<i>Flood Lights - Forward</i>	144
7.10.4	<i>Flood Lights - Rear</i>	145
7.10.5	<i>Swath Lights</i>	146
7.10.6	<i>Ambient Light</i>	148
7.10.7	<i>Turn Signal Indicators</i>	148
7.10.8	<i>Circuit Breakers and Fuses</i>	149
7.11	HYDRAULIC SYSTEM	152
7.11.1	<i>Oil Level</i>	152
7.11.2	<i>Changing Hydraulic Oil</i>	154
7.11.3	<i>Hydraulic Oil Cooler</i>	154
7.11.4	<i>Hydraulic Oil Filters</i>	154
7.11.5	<i>Header and Reel Hydraulics</i>	155
7.11.6	<i>Traction Drive Hydraulics</i>	158
7.11.7	<i>Hoses and Lines</i>	159
7.12	WHEELS AND TIRES	160
7.12.1	<i>Drive Wheels</i>	160
7.12.2	<i>Caster Wheels</i>	163
7.13	MAINTENANCE SCHEDULE	167
7.13.1	<i>Break-In Inspection</i>	167
7.13.2	<i>Interval Maintenance</i>	168
8	TROUBLESHOOTING	171
8.1	ENGINE	171
8.2	ELECTRICAL	173
8.3	HYDRAULICS	174
8.4	HEADER DRIVE	174
8.5	TRACTION DRIVE	175
8.6	STEERING AND GROUND SPEED CONTROL	176
8.7	CAB AIR	177
8.8	OPERATOR'S STATION	179
9	OPTIONS	180
9.1	REEL DRIVE & LIFT PLUMBING	180
9.2	WINDROWER HYDRAULIC COMPLETION FOR DRAPER HEADER REEL FORE/AFT	180
9.3	BOOSTER SPRING KIT	180
9.4	INTERNAL BOOSTER SPRING KIT	180
9.5	LIGHT HEADER FLOTATION KIT	180
9.6	AM-FM RADIO	180
9.7	HYDRAULIC CENTER LINK	180
9.8	FAN AIR BAFFLE KIT	180
9.9	TRAINING SEAT	180
9.10	KNIFE SPEED, REEL SPEED INDEX, AND TILT SENSOR MODULE	180
9.11	ANTI-SHIMMY KIT FOR CASTERS	180
9.12	SWATH ROLLER	180
9.13	WARNING BEACONS	180
9.14	AUTO-STEER	180
9.15	ENGINE BLOCK HEATER	180
9.16	TRANSPORT DRAWBAR	181
INDEX		181
CDM/WCM FAULT CODES		184
ENGINE ERROR CODES		185
 HYDRAULIC AND ELECTRICAL SCHEMATICS		

2 SAFETY

2.1 SAFETY ALERT SYMBOL



This safety alert symbol indicates important safety messages in this manual and on safety signs on the machine.

This symbol means:

ATTENTION!
BECOME ALERT!
YOUR SAFETY IS INVOLVED!

Carefully read and follow the safety message accompanying this symbol.

WHY IS SAFETY IMPORTANT TO YOU?

ACCIDENTS DISABLE AND KILL
ACCIDENTS COST
ACCIDENTS CAN BE AVOIDED

2.2 SIGNAL WORDS

Note the use of the signal words DANGER, WARNING, and CAUTION with safety messages. The appropriate signal word for each message has been selected using the following guidelines:



DANGER

Indicates an imminently hazardous situation that, if not avoided, will result in death or serious injury.



WARNING

Indicates a potentially hazardous situation that, if not avoided, could result in death or serious injury. It is also used to alert against unsafe practices.



CAUTION

Indicates a potentially hazardous situation that, if not avoided, may result in minor or moderate injury. It is also used as a reminder of good safety practices.

2.3 SAFETY SIGNS

2.3.1 Safety Sign Installation

Refer to the illustration on this and following pages and proceed as follows:

- Be sure the installation area is clean and dry.
- Decide on the exact location before you remove the decal backing paper.
- Remove the smaller portion of the split backing paper.
- Place the sign in position and slowly peel back the remaining paper, smoothing the sign as it is applied.
- Small air pockets can be smoothed out or pricked with a pin.

2.3.2 Safety Sign Locations

The safety signs (decals) appear on the windrower at the locations approximately as shown.

- Keep safety signs clean and legible at all times.
- Replace safety signs that are missing or become illegible.
- If original parts on which a safety sign was installed are replaced, be sure the repair part also bears the current safety sign.
- Safety signs are available from your Dealer Parts Department.

SAFETY

Safety Sign Locations (continued)



#32744 IN CAB



#32744 BELOW DOOR HANDLE



#44944 OIL RESERVOIR UNDER HOOD



#134070 FRONT OF PLATFORM

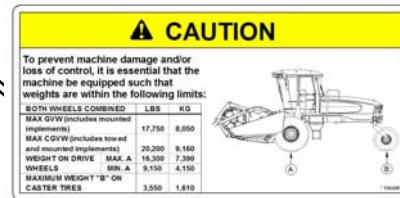

#160400 BEHIND DOOR

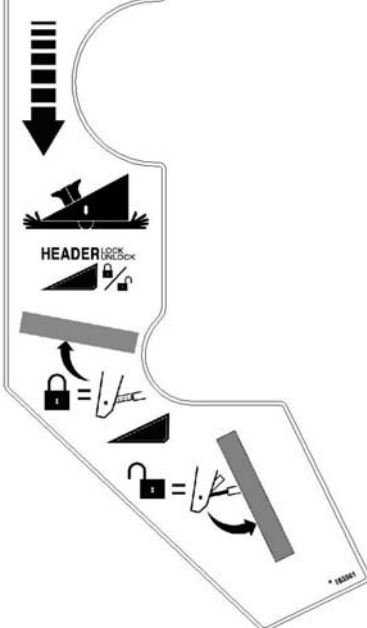

#163561 LIFT LINKAGES

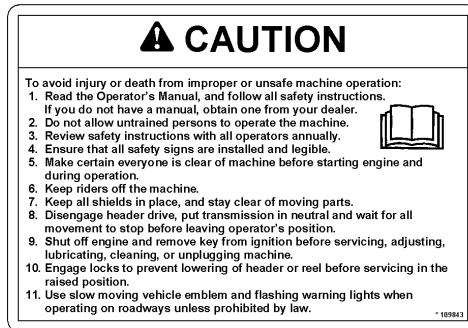

#109843 BEHIND DOOR

SAFETY

Safety Sign Locations (continued)

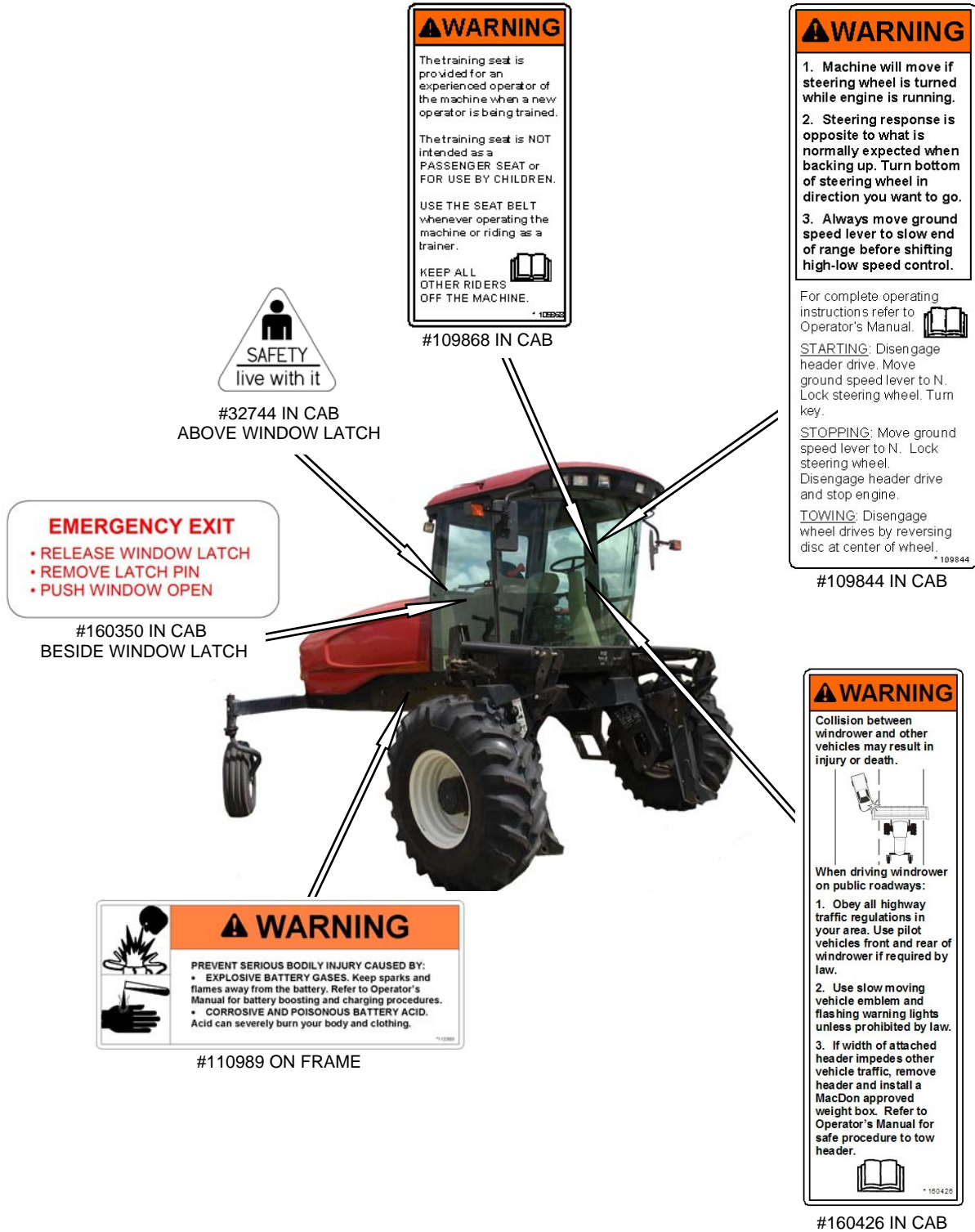

SAFETY

Safety Sign Locations (continued)

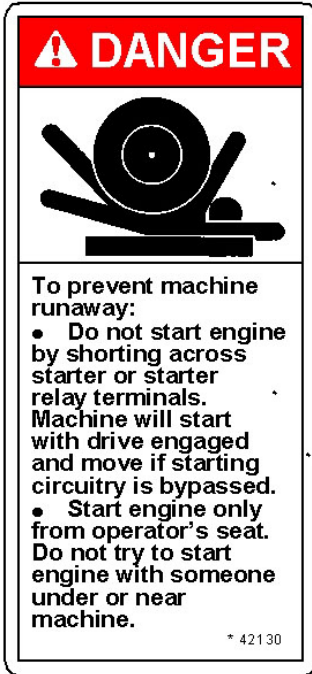

#42130 ON FRAME

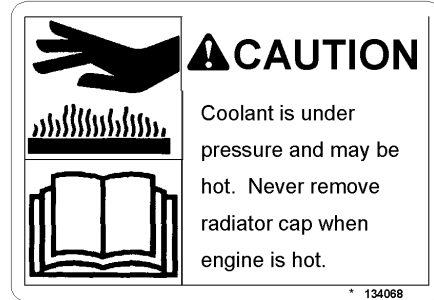

#134068 ON FAN SHROUD



#110986 ON FRAME

SAFETY

Safety Sign Locations (continued)



#110986 ON FRAME

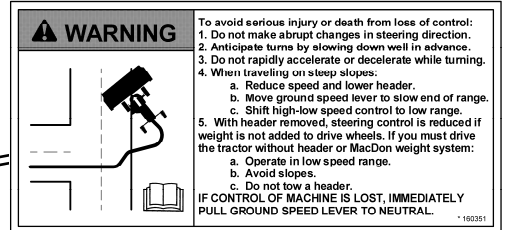

#160351 RH HEADLINER PANEL

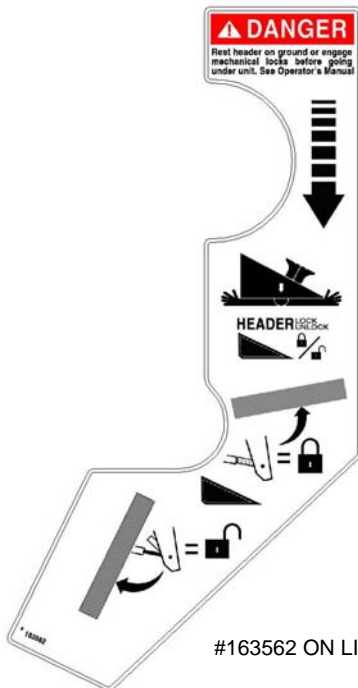
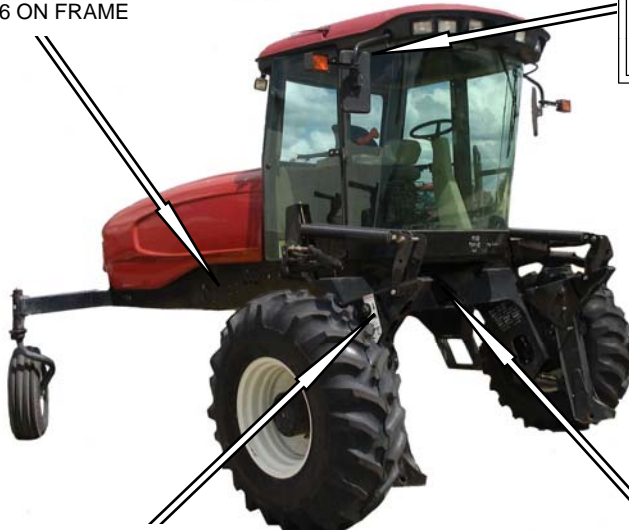

#163562 ON LIFT LINKAGE

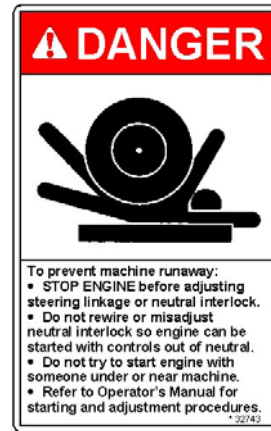

#32743 INSIDE FRAME

SAFETY

2.4 GENERAL SAFETY



CAUTION

The following are general farm safety precautions that should be part of your operating procedure for all types of machinery.

- Protect yourself.

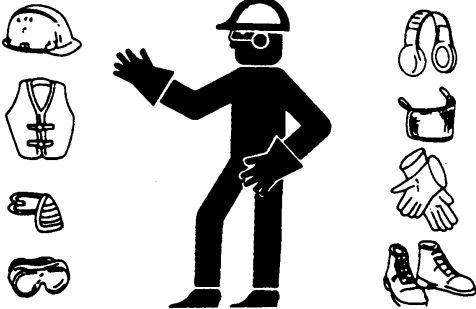

- When assembling, operating and servicing machinery, wear all the protective clothing and personal safety devices that COULD be necessary for the job at hand. Don't take chances.
- You may need:
 - a hard hat.
 - protective shoes with slip resistant soles.
 - protective glasses or goggles.
 - heavy gloves.
 - wet weather gear.
 - respirator or filter mask.
 - hearing protection. Be aware that prolonged exposure to loud noise can cause impairment or loss of hearing. Wearing a suitable hearing protective device such as ear muffs (A) or ear plugs (B) protects against objectionable or loud noises.



- Provide a first-aid kit for use in case of emergencies.
- Keep a fire extinguisher on the machine. Be sure the extinguisher is properly maintained and be familiar with its proper use.
- Keep young children away from machinery at all times.
- Be aware that accidents often happen when the operator is tired or in a hurry to get finished. Take the time to consider the safest way. Never ignore warning signs of fatigue.
- Wear close-fitting clothing and cover long hair. Never wear dangling items such as scarves or bracelets.
- Keep hands, feet, clothing and hair away from moving parts. Never attempt to clear obstructions or objects from a machine while the engine is running.

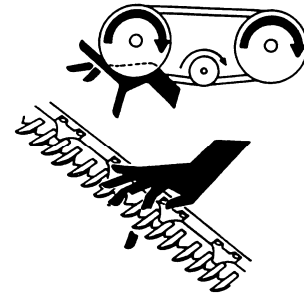

SAFETY

- Keep all shields in place. Never alter or remove safety equipment. Make sure driveline guards can rotate independently of the shaft and can telescope freely.
- Use only service and repair parts made or approved by the equipment manufacturer. Substituted parts may not meet strength, design, or safety requirements.
- Do not modify the machine. Unauthorized modifications may impair the function and/or safety and affect machine life.
- Stop engine and remove key from ignition before leaving operator's seat for any reason. A child or even a pet could engage an idling machine.
- Keep the area used for servicing machinery clean and dry. Wet or oily floors are slippery. Wet spots can be dangerous when working with electrical equipment. Be sure all electrical outlets and tools are properly grounded.
- Use adequate light for the job at hand.
- Keep machinery clean. Straw and chaff on a hot engine are a fire hazard. Do not allow oil or grease to accumulate on service platforms, ladders or controls. Clean machines before storage.
- Never use gasoline, naphtha or any volatile material for cleaning purposes. These materials may be toxic and/or flammable.
- When storing machinery, cover sharp or extending components to prevent injury from accidental contact.



ACRONYMS AND ABBREVIATIONS

3 ACRONYMS AND ABBREVIATIONS

TERM	DEFINITION
API	American Petroleum Institute
ASTM	American Society Of Testing And Materials
cc	cubic centimeters
C	Celsius
CDM	Cab Display Module
F	Fahrenheit
ft/min	feet per minute
ft/s	feet per second
gpm	U.S. gallons per minute
GSL	Ground Speed Lever
hp	horsepower
in.	inches
in ³	cubic inches
kg	kilograms
kPa	kilopascals
lbf.	pounds force
lbf.ft or ft-lbf	pound feet or foot pounds
lbf.in or in-lbf	pound inches or inch pounds
L/min	liters per minute
mm	millimeters
mph	miles per hour
N	Newtons
N·m	newton meters
N-DETENT	The slot opposite the neutral position on operator's console.
oz.	ounces
psi	pounds per square inch
rpm	Revolutions Per Minute
SAE	Society Of Automotive Engineers
SCA	Supplemental Coolant Additives
WCM	Windrower Control Module

Also See Section 7.3.3 Conversion Chart.

SPECIFICATIONS

4 SPECIFICATIONS

4.1 WINDROWER DIMENSIONS

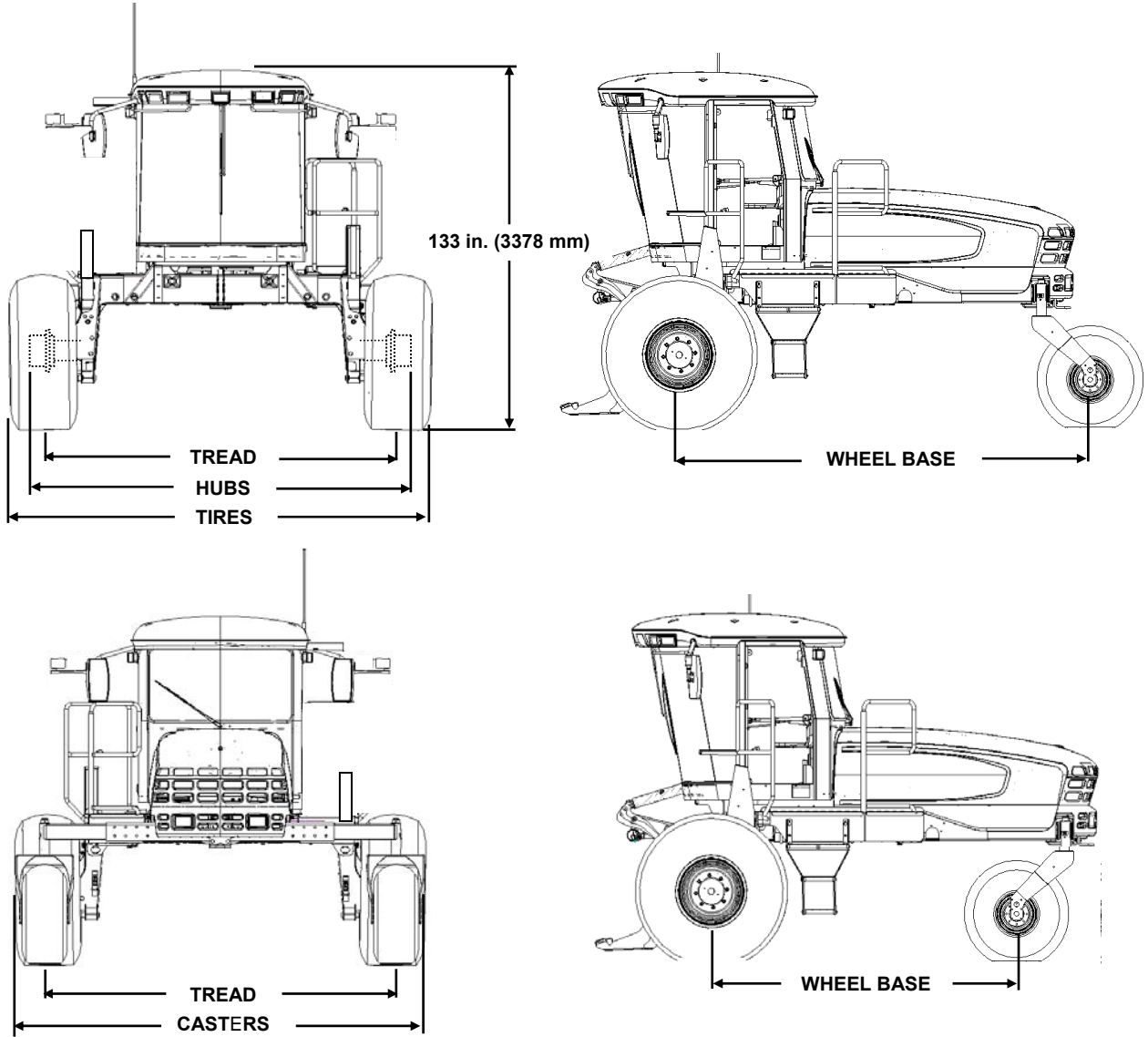

	WHEEL POSITION	TREAD Inch (mm)	HUBS Inch (mm)	CASTERS Inch (mm)	TIRES Inch (mm)	SHIPPING Inch (mm)	WHEEL BASE Inch (mm)	
							FWD	REV
DRIVE TIRE	Inner/Outer	-	138.7 (3522)	-	-	142.9 (3630)	158.3 (4021)	120.7 (3066)
	Outer/Outer	134.2 (3410)	146.1 (3712)	-	157.1 (3990)			
	Inner/Inner	120.1 (3050)	131.6 (3342)	-	150.0 (3810)			
CASTER TIRE	Minimum	93.2 (2367)	-	115.4 (2932)	-	-		
	Maximum	135.8 (3448)	-	158.0 (4013)	-	-		

NOTE: Above dimensions are with 18.4 - 26 drive tires and forked casters.

SPECIFICATIONS

4.2 SPECIFICATIONS

ENGINE				
Type	Cummins QSB-3.3 4 Cyl. Turbo			
Displacement	200 cu. in. (3.3liters)			
Power	Rated	99 hp (74 kW) @ 2600 rpm		
	Peak	99 hp (74 kW) @ 2000 rpm		
Maximum RPM (no load)	2630-2650			
Idle RPM	1100			
ELECTRICAL SYSTEM				
Recommended Battery	Group Rating 31A. Max Dim – 13L.x6.81W.x9.43H. in. (330x173x240 mm). 12 Volt, Min. 950CCA Heavy Duty/Off Road/Vibration Resistant.			
Alternator	120 amp			
Starter	Dry Type			
Working Lights	11			
TRACTION DRIVE				
Type	Hydrostatic, 2 Speed Electric Shift			
Speed	Field	Lo Range 0-11 mph (17.7 km/h)		
	Reverse	6 mph (9.6 km/h)		
	Transport	High Range 0-16 mph (25.6 km/h)		
Transmission	Type	2 Piston Pumps – 1 per Drive Wheel.		
	Displacement	3.0 cu.in. (49 cc)		
	Flow	33 U.S. gpm (129 L/min)		
Final Drive	Type	Planetary Gearbox		
	Ratio	41.42 : 1		
Wheel Motor Displ.	Lo Range	2.8 cu.in. (46 cc)		
	Hi Range	1.7 cu.in. (27 cc)		
SYSTEM CAPACITIES				
Fuel Tank	97 U.S. Gallons (378 liters)			
Cooling	5.1 U.S. Gallons (20 liters)			
Hydraulic Reservoir	11.5 U.S. Gallons (45 liters)			
Crankcase	1.9 U.S. Gallons (7 liters)			
HEADER DRIVE				
	Type	Displacement	Flow	Max. Press.
Knife Drive – Pump A (Mechanically Adjustable)	Piston	3.0 cu.in. (0-49 cc)	0-30 U.S. gpm (117 L/min)	4000 psi (27579 kPa)
Reel Drive – Pump B	Gear	1.02 cu.in. (16.7 cc)	0-11.5 U.S. gpm (45 L/min) @ 2600 rpm	2600 psi (17926 kPa)
Conveyor – Pump C				

(continued next page)

SPECIFICATIONS

HEADER LIFT/TILT		
Type		Hydraulic
Gear Pump	Displacement	1.02 cu.in. (16.7 cc)
	Flow	11.5 U.S. gpm (46.5 L/min)
System Pressure (Relief/Max)		2500 psi (17.24 MPa)
Header Tilt		Mechanically Adjustable Link (Optional Hydraulic Cylinder Adjustable From Cab)
HEADER FLOTATION		
Adjustable Springs		Manual, External, Draw-Bolt With Springs (1 per side)
CAB		
Dimensions	Width	63 in. (1600 mm)
	Depth	68.3 in. (1735 mm) (at top of window)
	Height	64.6 in. (1640 mm)
	Volume	125 cu.ft. (3540 liters)
Seat	Driver	Mechanical Suspension, Seat Belt
	Training (Optional)	Folding, Cab Mounted, Seat Belt
Windshield Wiper	Front	31.5 in. (800 mm) Blade
Heater		24,000 Btu/h (7038 W)
Air Conditioning		28,280 Btu/h (8288 W)
Electrical Outlets		One Live, One On Ignition, One Live/Keyed.
Mirrors		Two Outside
Radio		Two Speakers and Antenna Factory Installed. Dealer Installed Radio
SYSTEM MONITORING		
Speeds		Ground (mph or km/h), Engine (rpm), Knife (spm) Optional, Reel (rpm) Optional, Conveyor (Ref. No.)
Header		Height, Angle (Optional)
TIRE OPTIONS		
Size	Drive	18.4 - 26 Bar, 18.4 - 26 Turf, 600-65 R28 Bar, 23.1 - 26 Turf, 580-70 R26 Turf
	Rear	7.5 – 16SL Single Rib Formed Caster, 10 x 16 Formed/Forked Caster 16.5L – 16.1 Rib Implement Flotation, Forked Caster
Pressure	Drive	Bar – 32 psi (221 kPa), Turf – 20 psi (138 kPa)
	Rear	10 psi (69 kPa)
FRAME AND STRUCTURE		
Dimensions		Refer to Section 4.1, Windrower Dimensions
Frame to Ground (Crop Clearance)		45.7 in. (1160 mm)
Weight		Approx. 9900 lb (4491 kg)
NG Header Compatibility	SK	A30S Auger, D50 & D60S Harvest Header (35' Max.)
	DK	A30D, A40D Auger, D60D Harvest Header (35' Max.)

- NOTES: 1. Specifications and design are subject to change without notice or obligation to revise previously sold units.
2. Weights do not include options.

OPERATOR'S STATION

5 OPERATOR'S STATION

The operator's station is designed for operating the windrower in a cab forward mode.

5.1 OPERATOR CONSOLE



The console contains controls to operate the windrower as well as amenities for the operator.

5.2 SEAT ADJUSTMENTS

The operator's seat has several adjustments. Refer to the following illustration for the location and description of each adjustment.

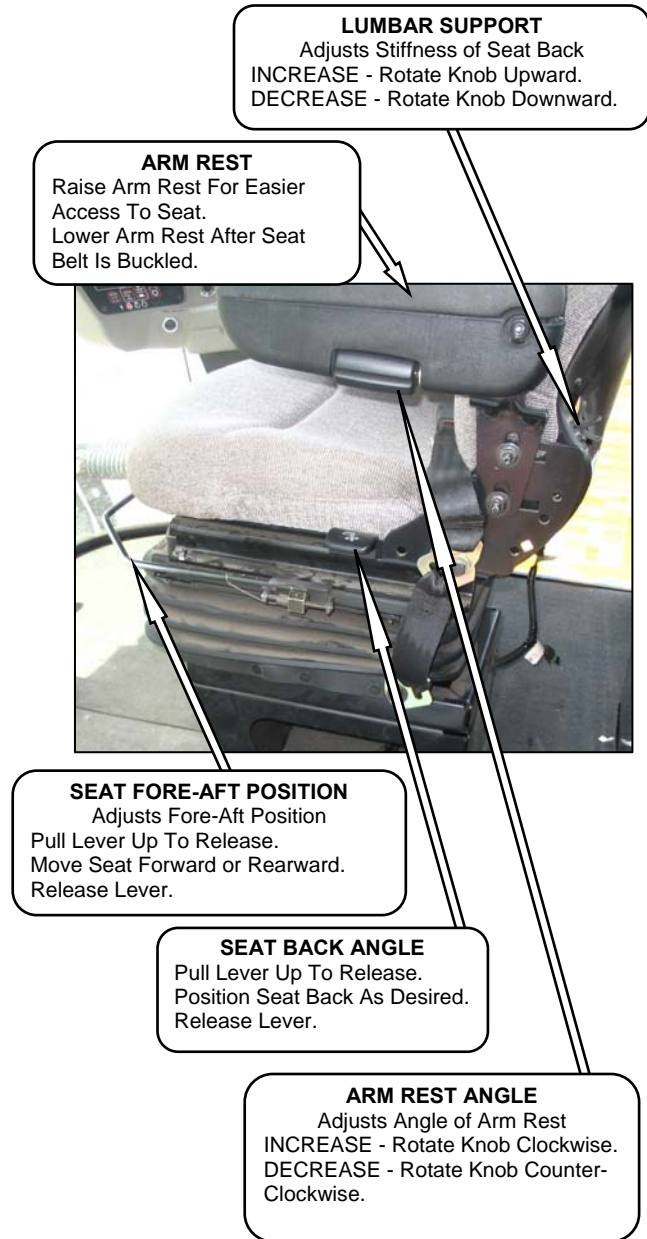

OPERATOR'S STATION

5.3 TRAINING SEAT (Optional)

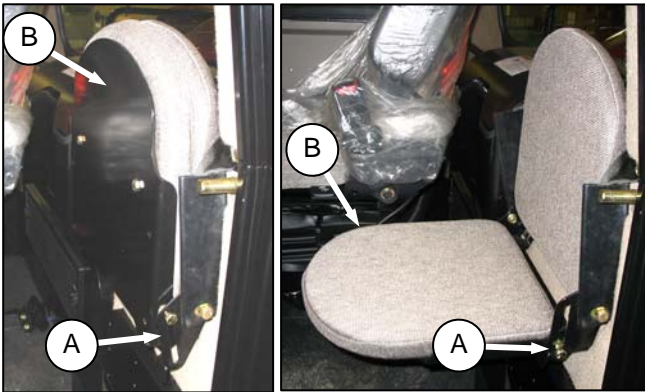

A wall mounted fold-up training seat complete with seat belt is provided for use as described below. To lower seat, lift latch (A) and lower seat (B). For storage, lift seat (B) and secure with latch (A).



WARNING

The training seat is provided for an experienced operator of the machine when a new operator is being trained.

The training seat is **NOT** intended as a **PASSENGER SEAT** or **FOR USE BY CHILDREN**.

USE THE SEAT BELT whenever operating the machine or riding as a trainer.

KEEP ALL OTHER RIDERS OFF THE MACHINE.

5.4 SEAT BELTS

The windrower is equipped with a seat belt on the Operator's and Trainer's seats.



WARNING

- Before starting engine, securely fasten your seat belt and ensure trainer's seat belt is fastened if occupied. The seat belt can help insure your safety if it is used and maintained.
- Never wear a seat belt loosely or with slack in the belt system.
- Never wear the belt in a twisted condition or pinched between the seat structural members.

- To fasten seat belt, pull belt completely across your body. Push the metal eye into the buckle until it locks. Adjust the position of the belt as low on your body as possible.



- To release, push the red button in the end of the buckle and separate the buckle and metal eye.

5.5 STEERING COLUMN ADJUSTMENT

The steering column can be adjusted to suit each particular operator and for easier entry to and exit from the seat.



- Hold onto steering wheel, step on lever (C), and move steering wheel up or down to desired position.
- Release lever (C) to lock steering wheel position.

OPERATOR'S STATION

5.6 OPERATOR PRESENCE

The Operator Presence System is a safety feature that is designed to deactivate or alarm selected systems when the operator is not seated at the operator's station. These systems include:

- Header Drive
- Transmission
- Engine

5.6.1 Header Drive

- Requires the operator to be seated in the seat in order to engage the header drive.
- Power is maintained to the header drive for 5 seconds after the operator leaves the seat, and then the header shuts down.
- If the seat switch is open for more than 5 seconds and the seat switch is closed again, it requires the operator to move the header engage switch to "OFF" position and back to the "ON" position again to restart the header.

5.6.2 Transmission

- If the operator leaves the seat and the transmission is not locked in neutral, after 2 seconds the lower display will flash "NOT IN NEUTRAL" accompanied by an alarm.

5.6.3 Engine

- The engine will not be allowed to start when the header drive switch is engaged.
- The engine will not be allowed to start when the transmission is not locked in neutral.
- The engine will shutdown when the windrower is moving at 5 mph (8 km/h) or less and the operator leaves the seat.

OPERATOR'S STATION

5.7 LIGHTS

The field and transport light switches are located on a panel in the cab headliner. Refer to illustrations on following pages for location of lights.

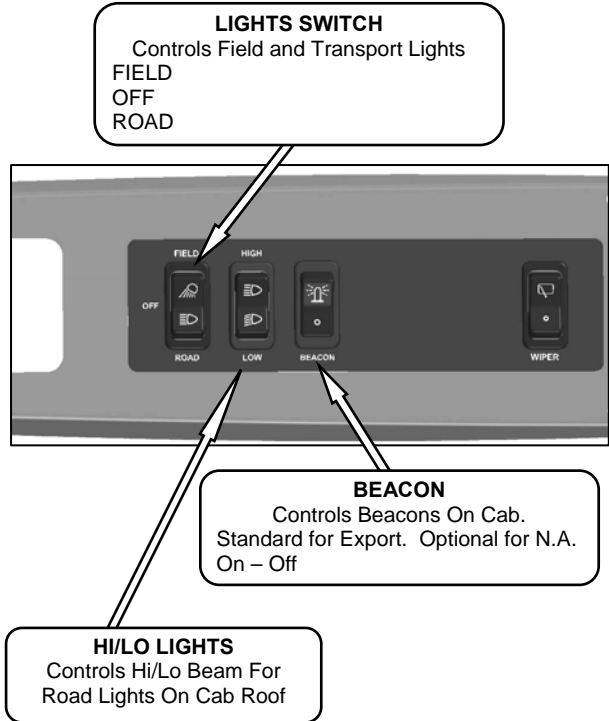

5.7.1 Field Lighting

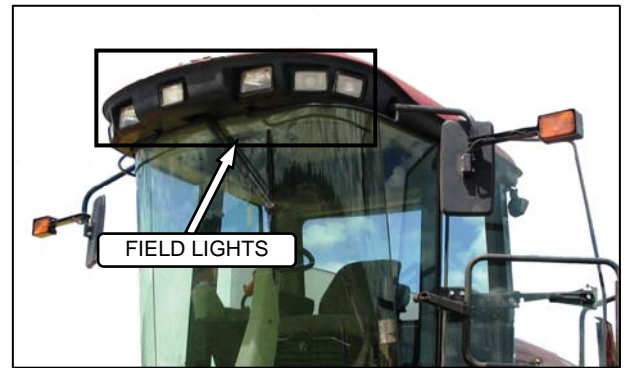

FRONT

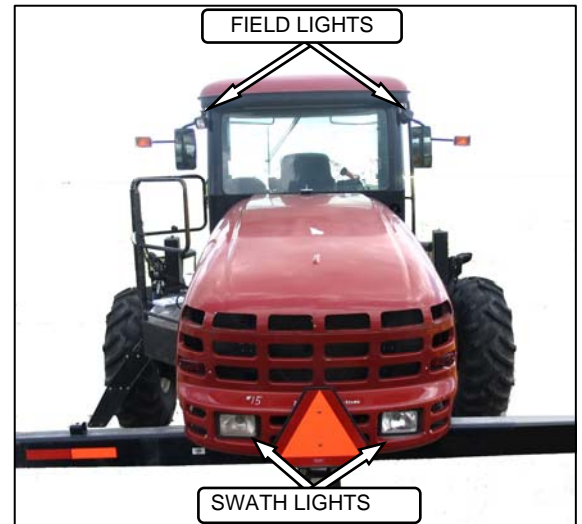

REAR

OPERATOR'S STATION

5.7.2 Road Lighting

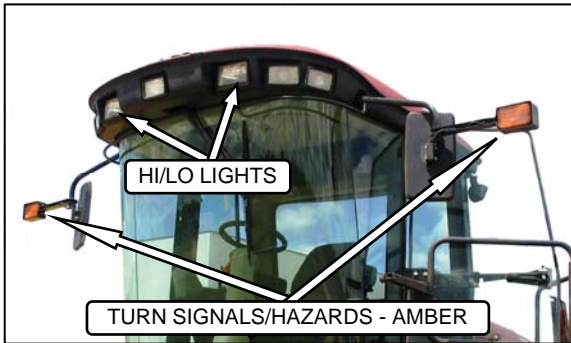
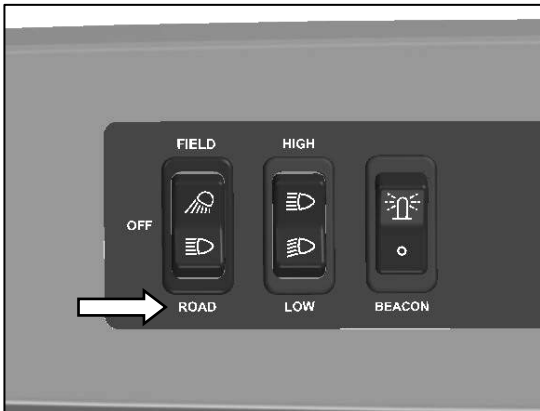

FRONT



REAR

5.7.3 Beacon Lighting – Export

The beacon lights are functional when the ignition and the beacon switches are on. The beacons must be used when driving on the road.

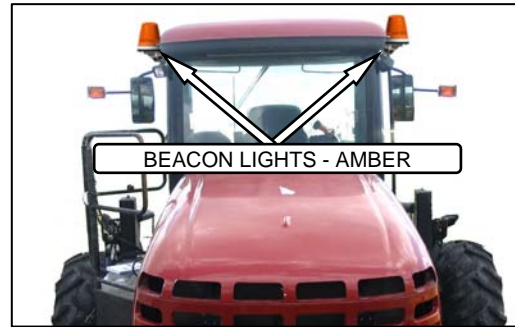

OPERATOR'S STATION

5.8 WINDSHIELD WIPERS



The windshield wiper control is located in the cab headliner.

5.9 REAR VIEW MIRRORS



Two adjustable outside mounted mirrors provide rear view vision.

OPERATOR'S STATION

5.10 CAB TEMPERATURE

The cab environment is controlled by a climate-control system that provides clean air-conditioned or heated air for the operator. The heater/evaporator/blower assembly is located under the cab floorboard and is accessible from beneath the windrower.

5.10.1 Controls

Refer to the following illustrations for an explanation of the controls and operating procedures.

IMPORTANT

To distribute the oil throughout the system, perform the following steps whenever the machine is first started after storage for more than one week:

- a. Ensure heater shut-off valve at engine is open. See 5.10.3 Heater Shut-off Valve.

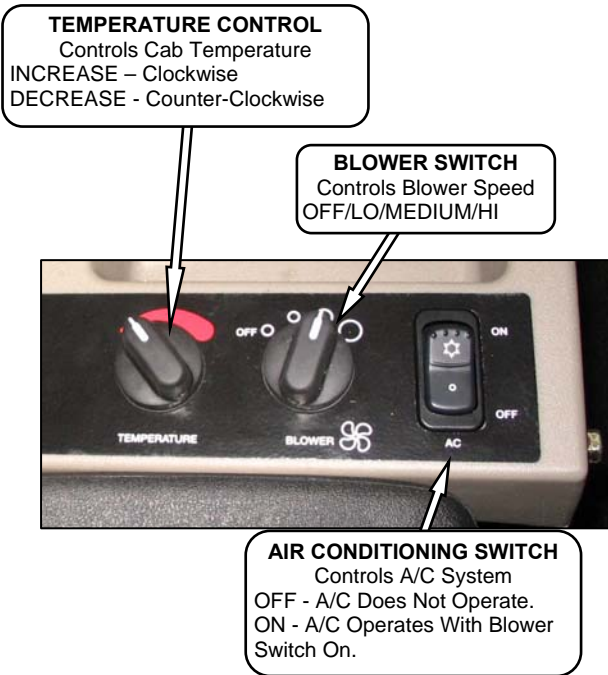

- b. Turn blower switch to the first position, turn temperature control switch to maximum heating, and A/C control to "OFF".
- c. Start engine and operate at low idle until engine is warm.
- d. Click A/C switch from "OFF" to "ON" for one second, then back to "OFF" for 5 to 10 seconds. Repeat this step ten times.

5.10.2 Air Distribution

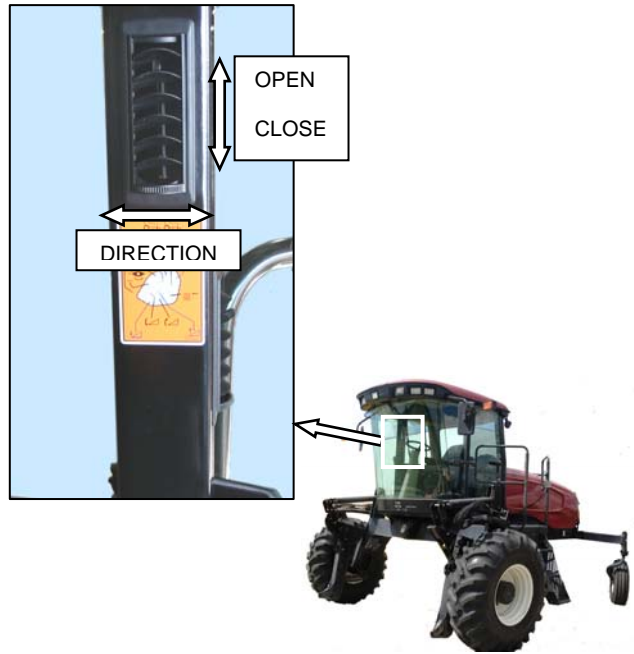

Cab air distribution is controlled through adjustable air vents. They are located in the cab posts to provide window and operator ventilation as shown in illustration.

5.10.3 Heater Shut-Off Valve

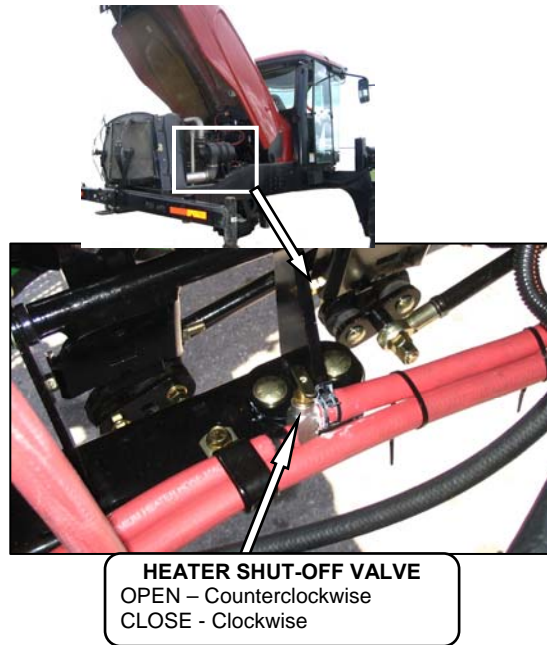

A shut-off valve at the engine allows the cab heater to be isolated from the engine coolant. The valve must be open to provide heat to the cab but for maximum cooling, the valve can be closed.

OPERATOR'S STATION

5.10.4 A/C Compressor Protection

The compressor is protected from excessively low and high pressures by two switches that shut down the compressor to prevent damage to the system.

- The LOW pressure switch opens when the pressure falls to 5.1-10.9 psi (35-75 kPa) and shuts down the compressor. When the pressure rises to 17.6-26.4 psi (121-182 kPa), the switch closes and allows the compressor to run.
- The HIGH pressure switch opens and stops the compressor when the pressure rises to 315-335 psi (2172-2310 kPa). When the pressure falls to 220-280 psi (1517-1930 kPa), the switch closes and allows the compressor to run.
- The Windrower Control Module (WCM) gives a warning when it senses rapid pressure changes that cause the compressor to rapidly engage and disengage.

If the air conditioning system is shut down by either switch, locate the source of the problem and correct it before operating the system.

5.11 INTERIOR LIGHTS

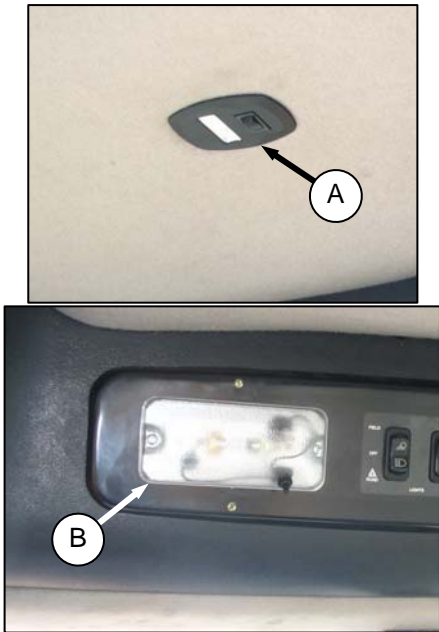

Two interior lights are installed in the cab headliner. A low intensity LED light (A) is located directly overhead to provide ambient lighting if desired, and functions only when the road/field light switch is on. An on-off switch is located on the light.

The other interior light (B) is located on the headliner switch panel and the push-on, push-off button is located on the light.

5.12 OPERATOR AMENITIES

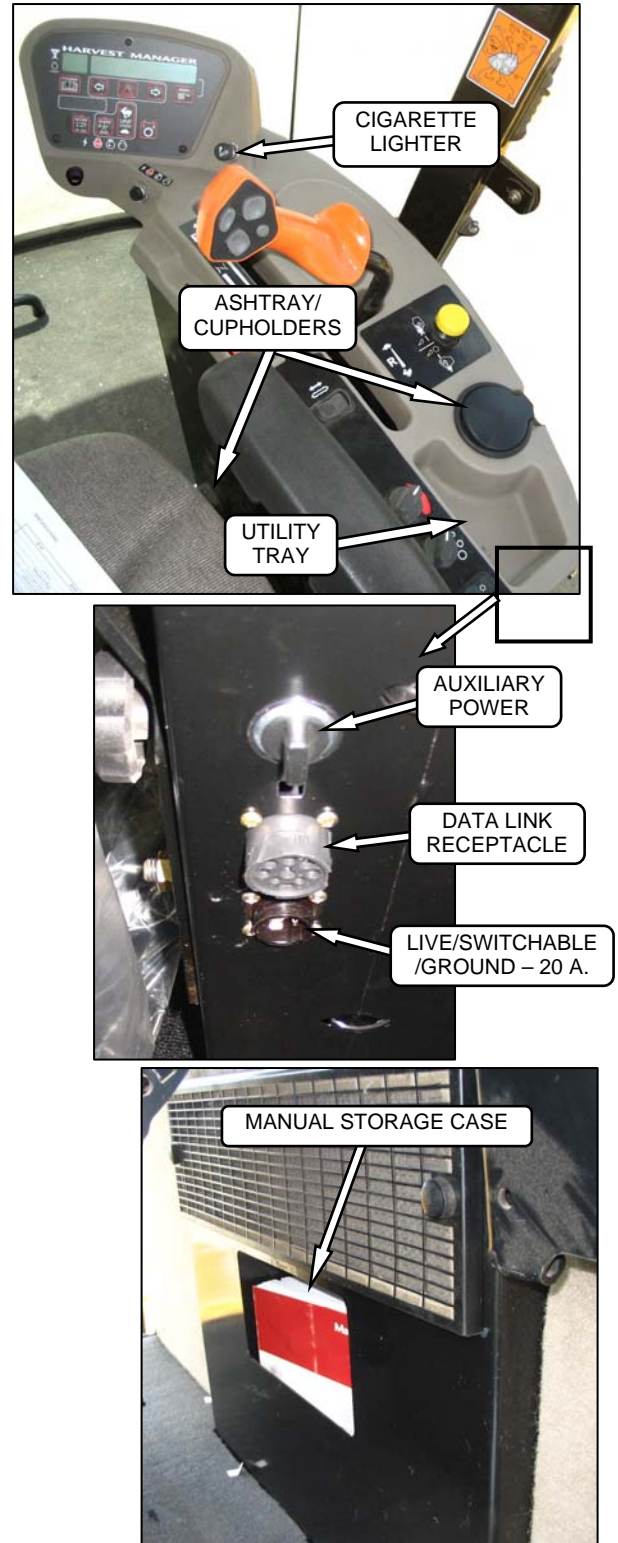

OPERATOR'S STATION

5.13 RADIOS

5.13.1 AM/FM Radio

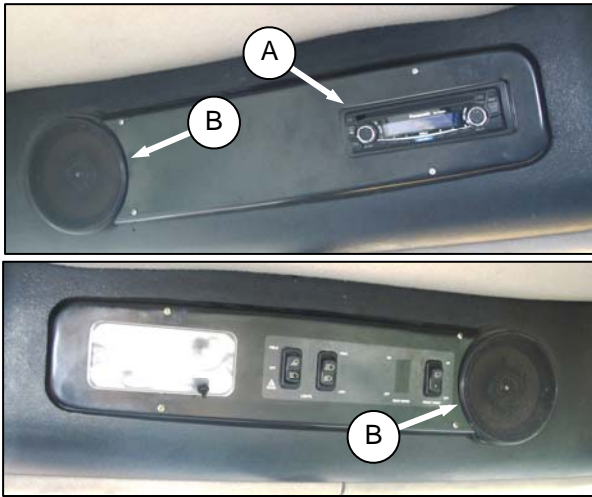

A radio (A) is available as optional equipment from your dealer and a space is provided in the cab headliner to accommodate the installation. Two pre-wired speakers (B) have been factory installed in the headliner. Refer to M100 Self-Propelled Windrower Unloading and Assembly Instruction for radio installation procedures. Operating instructions are supplied with the radio.

5.13.2 Antenna Mounting

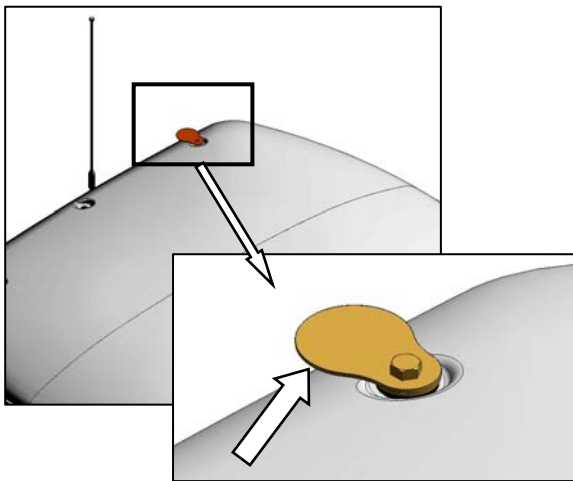

A roof mounted antenna base for installing a magnetic antenna is available as an option from your dealer. Order part #160288, or see illustration for part dimensions for a "homemade" version. It accommodates most CB, 2-way radio and satellite radio antennas. Refer to M100 Self-Propelled Windrower Unloading and Assembly Instruction for installation procedures.

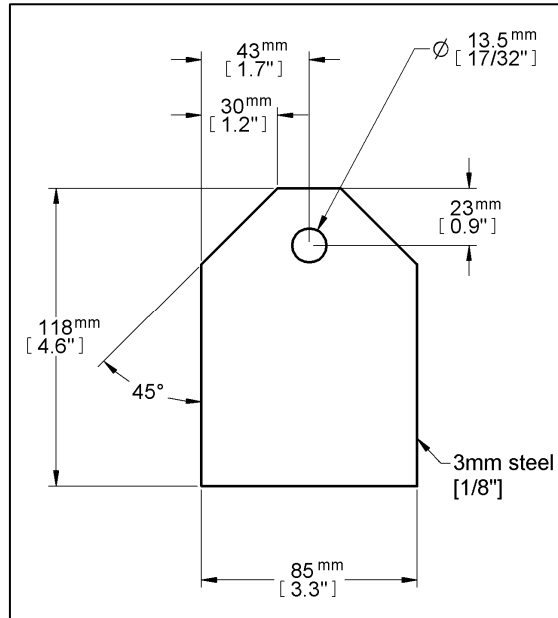

11 GA. OR 3.0 mm CQHRS

IMPORTANT

Antenna base can only be installed on the LH and RH rear cab roof bolts.

5.14 HORN

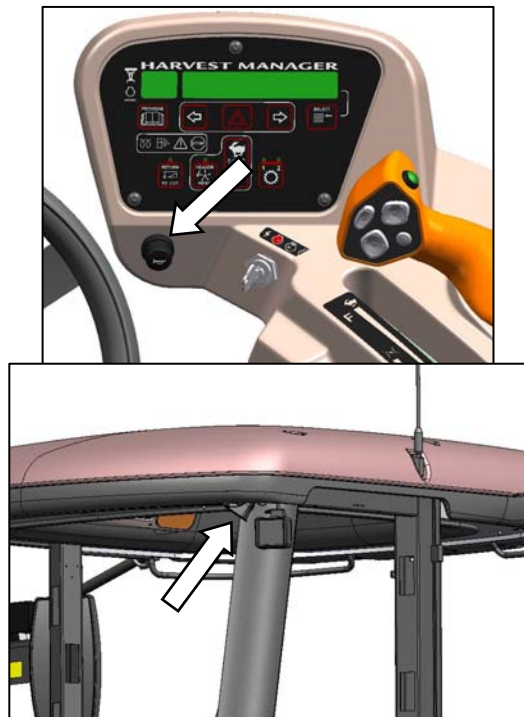

The horn is activated by pushing the button located beside the ignition key. The ignition switch must be on. Sound the horn three times prior to starting the engine.

OPERATOR'S STATION

5.15 ENGINE CONTROLS/GAUGES

All engine controls are conveniently located on the operator's console. Refer to the following illustration for the location and a description of each.

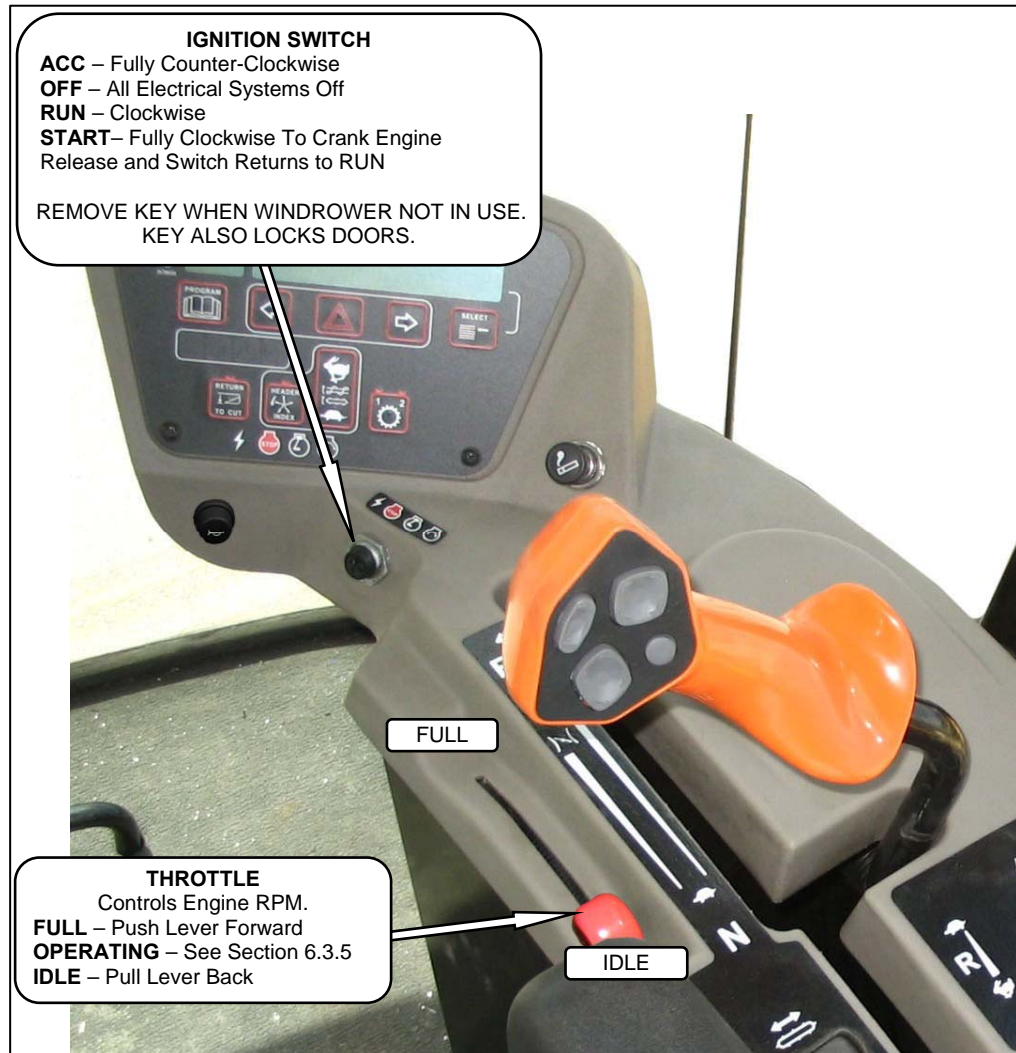

OPERATOR'S STATION

5.16 WINDROWER CONTROLS



OPERATOR'S STATION

5.17 HEADER CONTROLS

All header controls are conveniently located on the operator's console and on the GSL handle.

NOTE

Some controls are optional equipment and may not be present in your unit. Some controls may be installed, but will be non-functional for certain headers.

5.17.1 Header Engage Switch



Engages and disengages header drive.

IMPORTANT

Always move throttle lever back to idle before engaging header drive. Do not engage header with engine at full RPM.

5.17.2 GSL Header Switches

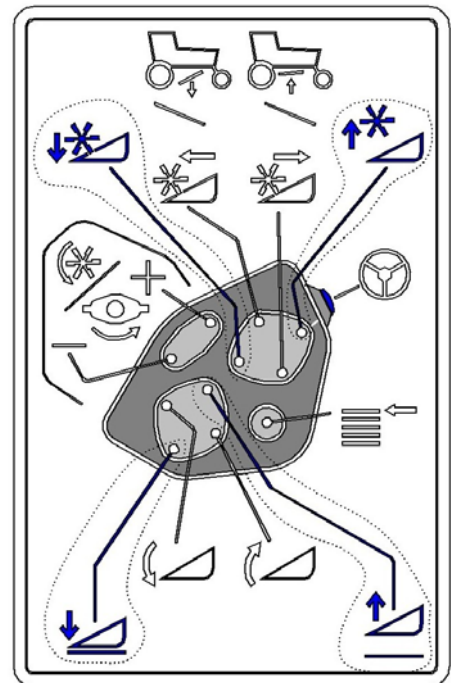

The GSL (A) contains switches for the following header functions that are most often adjusted while in operation to suit changing crop conditions. All are momentary type switches. A decal that identifies the switch functions is located on the cab post above the operator's console.

- Display Selector
- Reel Position
- Header Position
- Reel Speed

OPERATOR'S STATION

5.17.2.1 Display Selector Switch

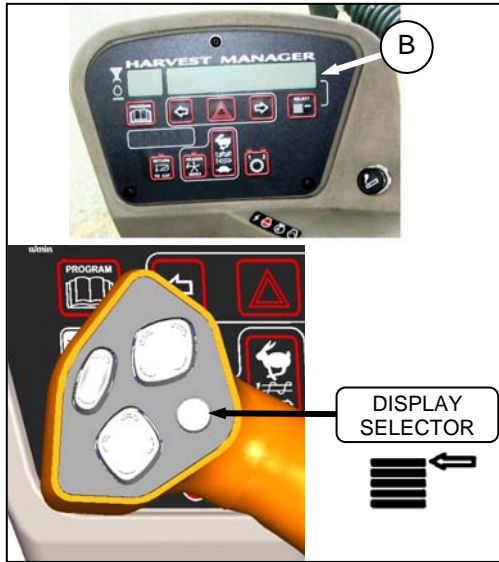

Selects and displays the settings in the CDM (B) top line read-out for each of the header controls.

- Press switch to scroll through settings.

5.17.2.2 Reel Position Switches

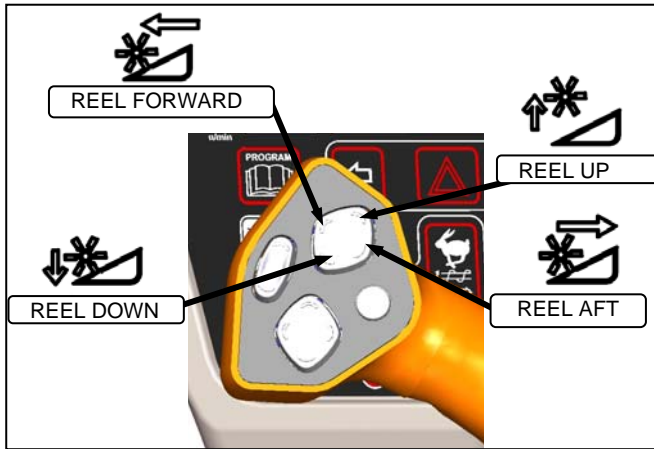

NOTE

Reel position switches work only on draper headers.

Press and hold switch at location shown to move reel.

Release switch at desired position.

5.17.2.3 Header Position Switches

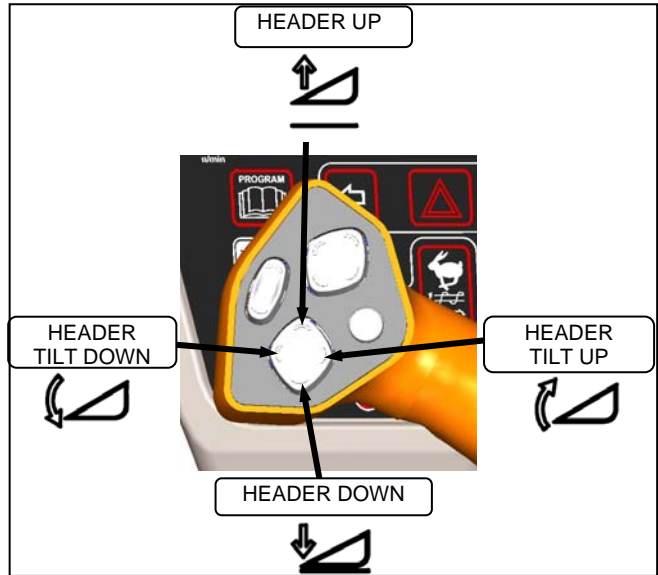

Press and hold switch at location shown to move header.

Release switch at desired position.

5.17.2.4 Reel Speed Switches

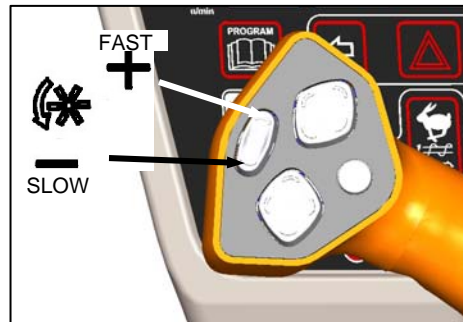

Press and hold switch at location shown to change reel speed.

Release switch at desired speed.

NOTE

Auger speed adjusts proportionately when reel speed is changed. See Section 6 for further details.

OPERATOR'S STATION

5.17.3 Console Header Switches

The operator's console contains switches for the following header functions that are most often used while the windrower is stationary.

5.17.3.1 Deck Shift

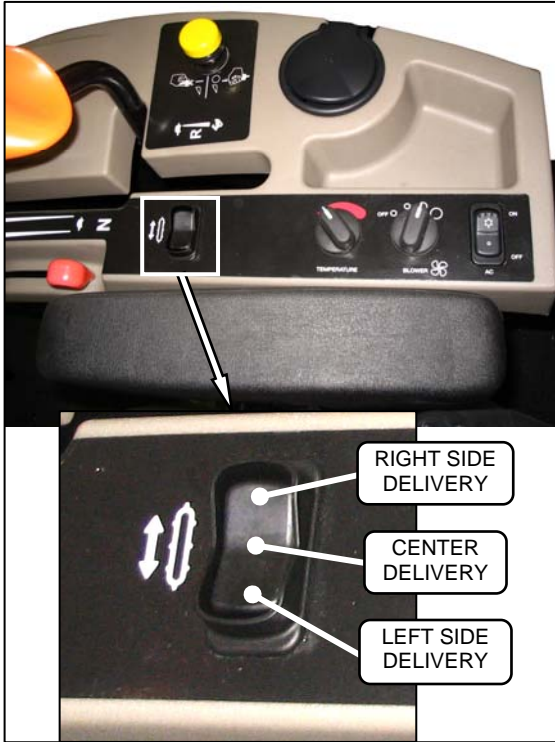

Draper Header with Deck Shift Option -
Controls deck shifting for double windrowing options with a draper header.

OPERATOR'S STATION

5.18 CAB DISPLAY MODULE (CDM)

5.18.1 Engine and Windrower Functions

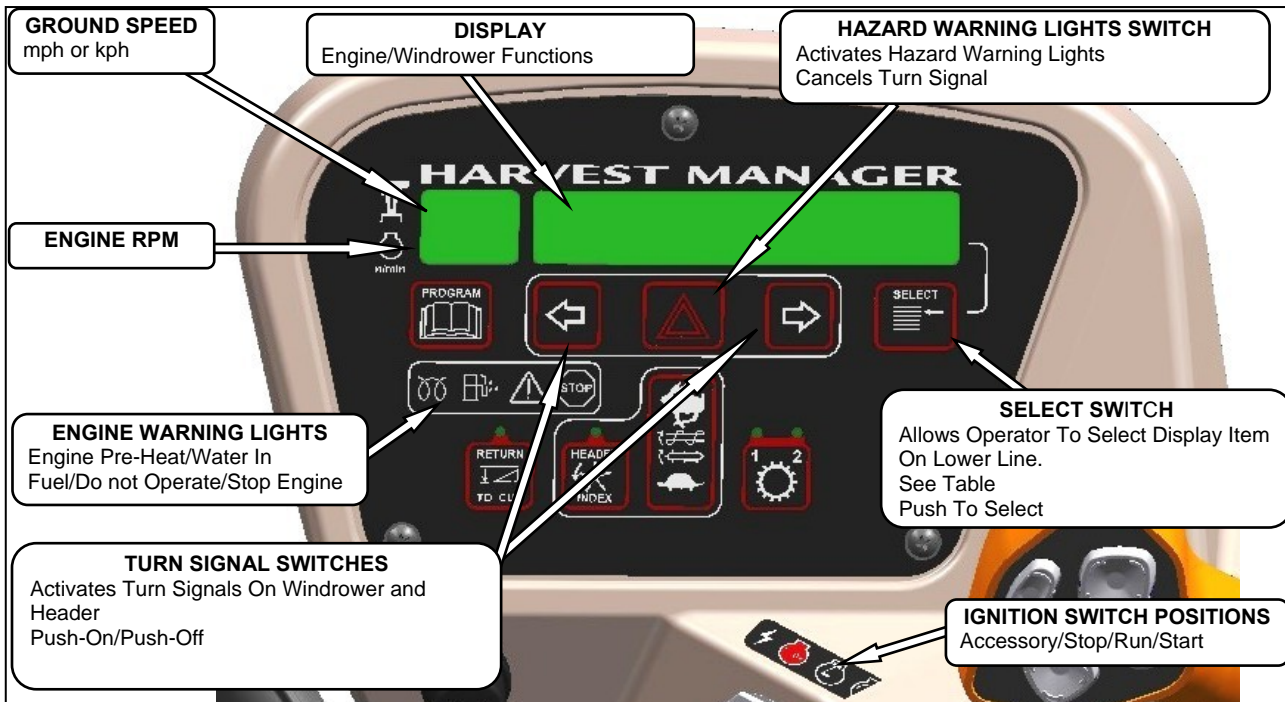

5.18.2 Header Functions

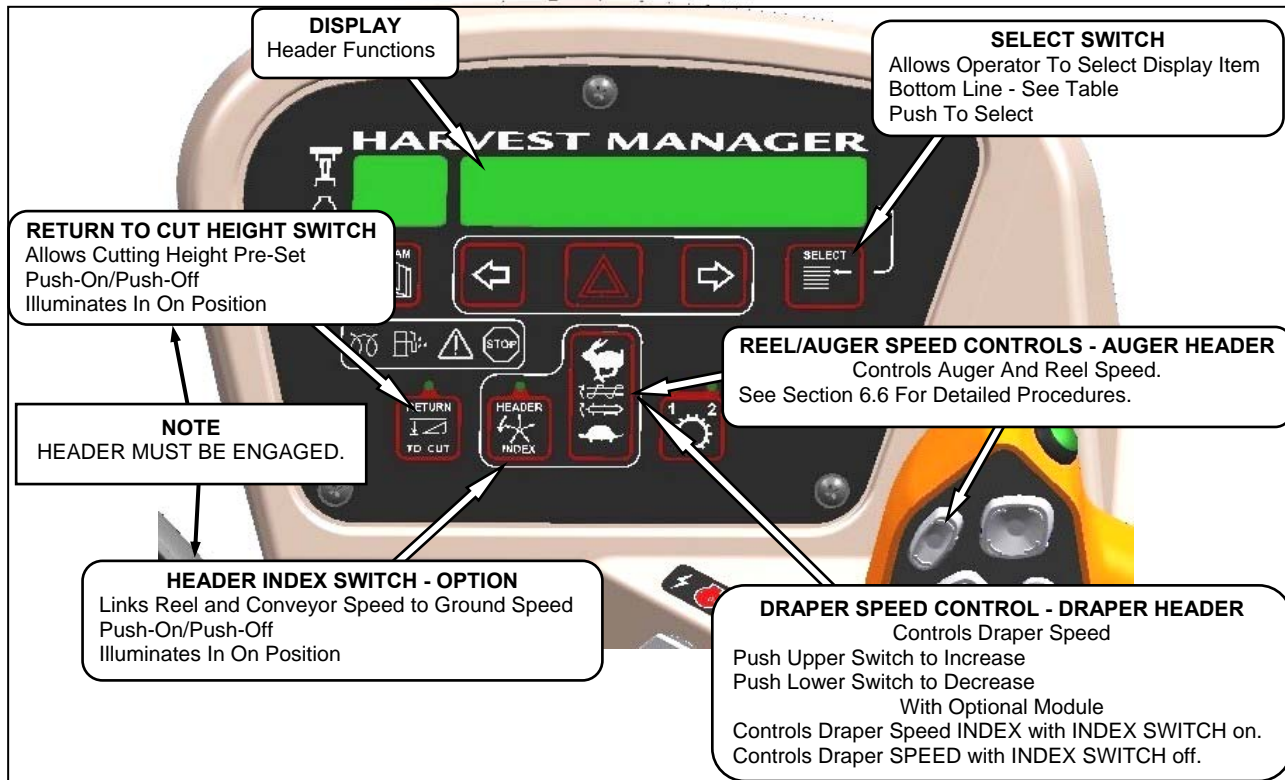

OPERATOR'S STATION

5.18.3 Operating Screens

The M100 windrower Cab Display Module (CDM) and the Windrower Control Module

(WCM) provide information on several functions for the engine, header, and windrower. The information displayed in various operating modes is described in the following sections:

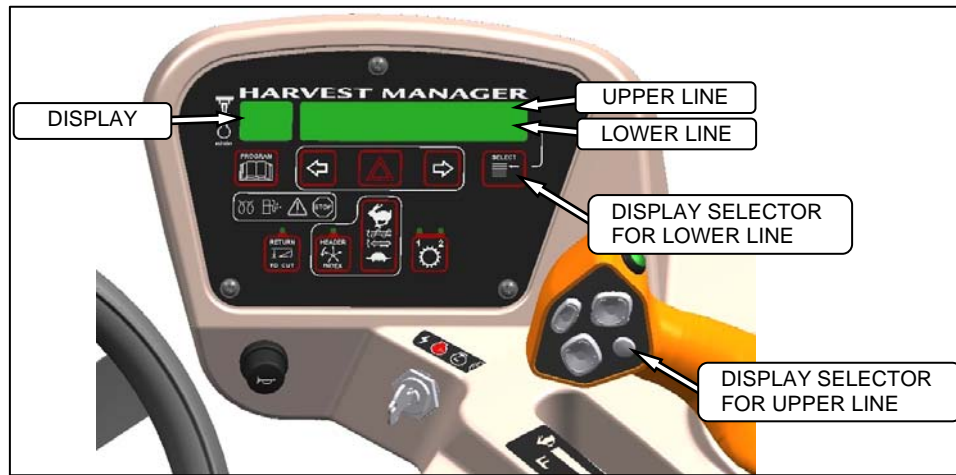

IGNITION ON/ENGINE NOT RUNNING

DISPLAY (Upper Line)(2-3 Seconds)	DESCRIPTION
HEADER DISENGAGED	Indicates Header Engage Switch Is Off.
IN PARK	Indicates GSL In Neutral Detent.

ENGINE RUNNING/HEADER DISENGAGED

(Scroll Through Display with CDM Switch or GSL Switch)

DISPLAY (Lower or Upper Line)	DESCRIPTION
#####.# ENGINE HRS	Total Engine Operating Time.
#####.# HEADER HRS	Total Header Operating Time.
###.# SUB ACRES ###.# SUB HECTARES (If Metric)	Area Cut Since Last Reset. To Reset, Display SUB ACRES On Lower Line And Hold Down Program Switch Until Display Resets (5-7 Seconds).
##### TOTAL ACRES ##### TOTAL HECT (If Metric).	Total Area Cut By Machine.
###.# HEADER HEIGHT	Distance Setting (00.0-10.0) Between Cutterbar & Ground.
###.# HEADER ANGLE (Optional)	Angle Setting (00.0-10.0) Header Relative to Ground.
FUEL LEVEL ■■■■ ■■■■	Level of Fuel In Tank.
ENGINE TEMP ### ° F ENGINE TEMP ### ° C (If Metric)	Engine Coolant Temperature.
###.# VOLTS	Engine Electrical System Operating Voltage.
SCROLL (Lower Line)	
ROAD GEAR (Upper Line)	Ground Speed Range Switch In High Range.

OPERATOR'S STATION

ENGINE RUNNING/HEADER ENGAGED AUGER HEADER

(Scroll Through Display with CDM Switch or GSL Switch)

DISPLAY (Lower or Upper Line)	DESCRIPTION
##### ENGINE HRS	Total Engine Operating Time.
##### HEADER HRS	Total Header Operating Time.
### ACRES/HOUR ### HECTARES/HOUR (If Metric)	Actual Cutting Rate In Acres (Hectares)/Hour.
### SUB ACRES ### SUB HECTARES (If Metric)	Area Cut Since Last Reset.
##### TOTAL ACRES ##### TOTAL HECT (If Metric)	Total Area Cut By Machine.
### REEL RPM (Optional) ### REEL SENSOR (If Sensor Disabled)	Reel Rotational Speed.
### AUGER SPEED	Auger Rotational Speed (0.0-10.0).
#### KNIFE SPEED (Optional) #### KNIFE SENSOR (If Sensor Disabled)	Knife Speed In Strokes Per Minute.
### HEADER HEIGHT ### HEADER SENSOR (If Sensor Disabled)	Distance Setting (00.0-10.0) Between Cutterbar & Ground.
### HEADER ANGLE (Optional) ### HEADER SENSOR (If Sensor Disabled)	Angle Setting (00.0-10.0) Header Relative To Ground.
FUEL LEVEL ■■■■ ■■■■ 	Level of Fuel In Tank.
ENGINE TEMP ### ° F ENGINE TEMP ### ° C (If Metric)	Engine Coolant Temperature.
### VOLTS	Engine Electrical System Operating Voltage.
SCROLL <i>SUB-MENU (Lower Line Only)</i> #### KNIFE SPEED (Optional) ### AUGER SPEED ### REEL RPM (Optional) ### HEADER HEIGHT FUEL LEVEL ■■■■ ■■■■ ENGINE TEMP ### ° F ENGINE TEMP ### ° C (If Metric)	Displays Sub-Menu After 2-3 Seconds. Press SELECT to cancel. Scroll Through Sub-Menu Display with CDM Switch

OPERATOR'S STATION
ENGINE RUNNING/HEADER ENGAGED
DRAPER HEADER/INDEX SWITCH OFF

(Scroll Through Display with CDM Switch or GSL Switch)

DISPLAY (Lower or Upper Line)	DESCRIPTION
#####.# ENGINE HRS	Total Engine Operating Time.
#####.# HEADER HRS	Total Header Operating Time.
##.# ACRES/HOUR ##.# HECTARES/HOUR (If Metric)	Actual Cutting Rate In Acres (Hectares)/Hour.
###.# SUB ACRES ###.# SUB HECTARES (If Metric)	Area Cut Since Last Reset.
##### TOTAL ACRES ##### TOTAL HECT (If Metric)	Total Area Cut By Machine.
###.# REEL MPH or RPM (Optional) ###.# REEL KPH (If Metric) ###.# REEL SENSOR (If Sensor Disabled)	Reel Peripheral Speed in miles per hour. Reel Speed in rpm.
##.# DRAPER SPEED	Draper Speed (0.0-10.0).
#### KNIFE SPEED (Optional) #### KNIFE SENSOR (If Sensor Disabled)	Knife Speed In Strokes Per Minute.
##.# HEADER HEIGHT ##.# HEADER SENSOR (If Sensor Disabled)	Distance Setting (00.0-10.0) Between Cutterbar & Ground.
##.# HEADER ANGLE (Optional) ##.# HEADER SENSOR (If Sensor Disabled)	Angle Setting (00.0-10.0) Header Relative To Ground.
FUEL LEVEL ■■■■ ■■■■ 	Level of Fuel In Tank.
ENGINE TEMP ### ° F ENGINE TEMP ### ° C (If Metric)	Engine Coolant Temperature.
##.# VOLTS	Engine Electrical System Operating Voltage.
SCROLL <i>SUB-MENU (Lower Line Only)</i> #### KNIFE SPEED (Optional) ###.# REEL RPM ##.# DRAPER SPEED FUEL LEVEL ■■■■ ■■■■ ENGINE TEMP ### ° F ENGINE TEMP ### ° C (If Metric) ##.# HEADER HEIGHT	Displays Sub-Menu After 2-3 Seconds. Press SELECT to cancel. Scroll Through Sub-Menu Display with CDM Switch
KNIFE SPD OVERLOAD (Lower Line)	Knife Speed Is Less Than Programmed Set-Point.



OPERATOR'S STATION

ENGINE RUNNING/HEADER ENGAGED DRAPER HEADER/INDEX SWITCH ON

(Scroll Through Display with CDM Switch or GSL Switch)

DISPLAY (Lower or Upper Line)	DESCRIPTION
#####.# ENGINE HRS	Total Engine Operating Time.
#####.# HEADER HRS	Total Header Operating Time.
##.# ACRES/HOUR ##.# HECTARES/HOUR (If Metric)	Actual Cutting Rate In Acres (Hectares)/Hour.
####.# SUB ACRES ####.# SUB HECTARES (If Metric)	Area Cut Since Last Reset.
##### TOTAL ACRES ##### TOTAL HECT (If Metric)	Total Area Cut By Machine.
##.## ##.# REEL IND (Optional) ##.## REEL SENSOR (If Sensor Disabled)	Reel Peripheral Speed Along With Ground Speed In MPH Or KPH.
##.# ##.# DRAP INDX	Draper Speed Along With Ground Speed In MPH Or KPH.
#### KNIFE SPEED (Optional) #### KNIFE SENSOR (If Sensor Disabled)	Knife Speed In Strokes Per Minute.
##.# HEADER HEIGHT ##.# HEADER SENSOR (If Sensor Disabled)	Distance Setting (00.0-10.0) Between Cutterbar & Ground.
##.# HEADER ANGLE (Optional) ##.# HEADER SENSOR (If Sensor Disabled)	Angle Setting (00.0-10.0) Header Relative To Ground.
FUEL LEVEL ■■■■ ■■■■ 	Level of Fuel In Tank.
ENGINE TEMP ### ° F ENGINE TEMP ### ° C (If Metric)	Engine Coolant Temperature.
##.# VOLTS	Engine Electrical System Operating Voltage.
SCROLL <i>SUB-MENU (Lower Line Only)</i> #### KNIFE SPEED (Optional) ##.# HEADER HEIGHT ##.## ##.# REEL INDRPM ##.# ##.# DRAP INDX FUEL LEVEL ■■■■ ■■■■ ENGINE TEMP ### ° F ENGINE TEMP ### ° C (If Metric)	Displays Sub-Menu After 2-3 Seconds. Press SELECT to cancel. Scroll Through Sub-Menu Display with CDM Switch
##.## REEL MIN RPM (Lower Line) (Optional)	Reel Speed Is Less Than Programmed Set-Point.
MINIMUM (Lower Line) (Optional)	

OPERATOR'S STATION
MISCELLANEOUS OPERATIONAL INFORMATION

DISPLAY (Upper Line)	DESCRIPTION
< LEFT TURN ■	Indicates Left Turn When  Is Pressed On CDM.
■ RIGHT TURN >	Indicates Left Turn When  Is Pressed On CDM.
■ HAZARD ■	Indicates Hazard Warning Lights Are On When  Is Pressed On CDM.
ROAD GEAR	With Hi Range Selected On Console Switch.
HEADER ENGAGED	Header Drive Engaged.

OPERATOR'S STATION

5.18.4 Cab Display Module (CDM) Warnings/Alarms

The CDM displays warnings and sounds alarms to notify the operator of abnormal windrower status at startup when the ignition is turned on and at engine operating speeds above 500 rpm.

5.18.4.1 Engine Warning Lights

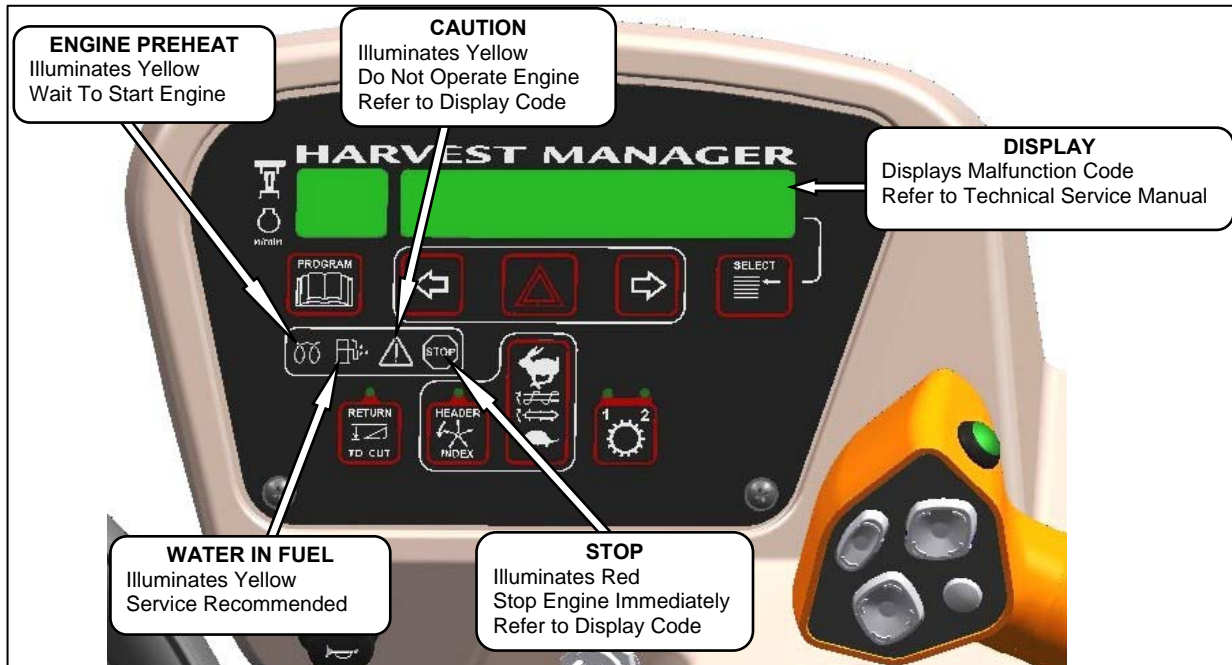

OPERATOR'S STATION

5.18.4.2 Display Warnings



DISPLAY WARNINGS AND ALARMS – ENGINE/TRANSMISSION

DISPLAY	FLASHING	ALARM TONE	DESCRIPTION
ENGINE OIL PRESSURE	✓	Continuous Loud Tone Until Oil Pressure Is Regained.	Low Engine Oil Pressure. Accompanied By Warning Lights.
ENGINE TEMPERATURE	✓	Ongoing Intermittent Moderate Tone Until Temperature Is Below 215F. (102C.)	Engine Temperature Over 230F. (110C.). Accompanied By Warning Lights.
### LOW VOLTS	✓	Single Loud Tone For 10 Seconds.	Voltage Below 11.5.
### HIGH VOLTS	✓	Single Loud Tone For 10 Seconds.	Voltage Above 16.
IN PARK	✓	One Short Beep	Steering Wheel Centered, And Brakes Are Engaged.
PLACE GSL INTO "N"		Beeps At 2 Per Second Until Corrected.	Interlock Switch Not Closed With Key On/Engine Off.
TRANS OIL PRESS	✓	Continuous Loud Tone Until Oil Pressure Is Regained.	Low Transmission Charge Oil Pressure.
TRANS OIL TEMP	✓	Ongoing Intermittent Moderate Tone Until Temperature Is Below Acceptable Level.	Transmission Oil Temperature Above 221F (105C).

OPERATOR'S STATION

DISPLAY WARNINGS AND ALARMS - WINDROWER

DISPLAY	FLASHING	ALARM TONE	DESCRIPTION
BRAKE OFF			Engine Running, Brake Solenoid Not Activated.
BRAKE SW FAILURE			Ignition On/Engine Not Running, Brake Switch And Relay Closed.
CENTER STEERING		Beeps At 2 Per Second	Interlock Switch Not Closed With Key On/Engine Off.
DISENGAGE HEADER	✓	None	Header Switch Is In On Position When Ignition Switch Turned On.
HEADER DISENGAGED		None	Normal
HEADER OIL PRESS	✓	Continuous Loud Tone Until Oil Pressure Is Regained.	Low Header Charge Oil Pressure. Header Shuts Down Automatically. Header On Switch Must Be Moved To Off Position And Then To On Position To Restart The Header.
HYDRAULIC FILTER	✓	Single Loud Tone For 10 Seconds. Repeats Every 15 Minutes Until Condition Is Corrected.	Excessive Pressure Drop Across Hydraulic Oil Filter.
KNIFE OVERLOAD	✓	Ongoing Intermittent Moderate Tone Until Condition Is Corrected.	Machine Overload. Knife Speed Drops Below Programmed Value.
LOW HYDRAULIC OIL	✓	Continuous Loud Tone For 5 Seconds. If Condition Not Rectified, Single Loud Tone Every 5 Minutes	Low Hydraulic Oil Level. Header Shuts Down Automatically If Engaged. Header On Switch Must Be Moved To OFF Position And Then To ON Position To Restart The Header.
NO HEADER		None	Header Is Not Detected.
NO OPERATOR		Continuous Tone.	Operator Not Detected In Seat With Header Engaged Or Out Of Neutral Detent. Engine Shutdown After 5 Seconds
NOT IN PARK	✓	Short Beep With Each Flash	Interlock Switch Not Closed With Key On/Engine Off.

OPERATOR'S STATION

5.18.5 Cab Display Module (CDM) Programming

The monitoring system requires programming for each header and the **header must be attached to the windrower**. Programming the system may be accomplished with or without the engine running. If the engine is running, the transmission must be in neutral. If the engine is not running, the ignition must be on. Exit programming mode at any time by pressing the PROGRAM switch or by turning off the ignition.

The system only needs to be programmed once for each header. The operator may make changes later on to a particular setting to suit windrowing conditions or modifications to the machine. Most functions have been pre-programmed at the factory but can be changed by the operator if required.

Proceed as follows to program the CDM:

IMPORTANT

Header must be attached to the windrower. See paragraph 6.5, & 6.6.

- Turn ignition key to RUN, or start the engine. Refer to paragraph 6.3.5 Engine Operation.
- Press PROGRAM and SELECT on CDM to enter programming mode.

- Press SELECT. TRACTOR SETUP? is displayed on upper line.
- Press \leftarrow and then SELECT.
- HEADER TYPE? is displayed. DRAPER is flashing on lower line.
- Press \leftarrow or \rightarrow to change value on lower line.
- Press SELECT.
- TILT CYL INSTALLED? is displayed.
- Press \leftarrow or \rightarrow to change value on lower line.
- Press SELECT to advance to the next L1 item and press arrow keys to change values.
- Press PROGRAM to exit programming mode when finished entering desired values.

Refer to Detailed Programming Instructions on following pages.

NOTE

Contact your dealer for information regarding software updates to the electronic modules. Your dealer will have the necessary interface tools and access to the latest software upgrades.

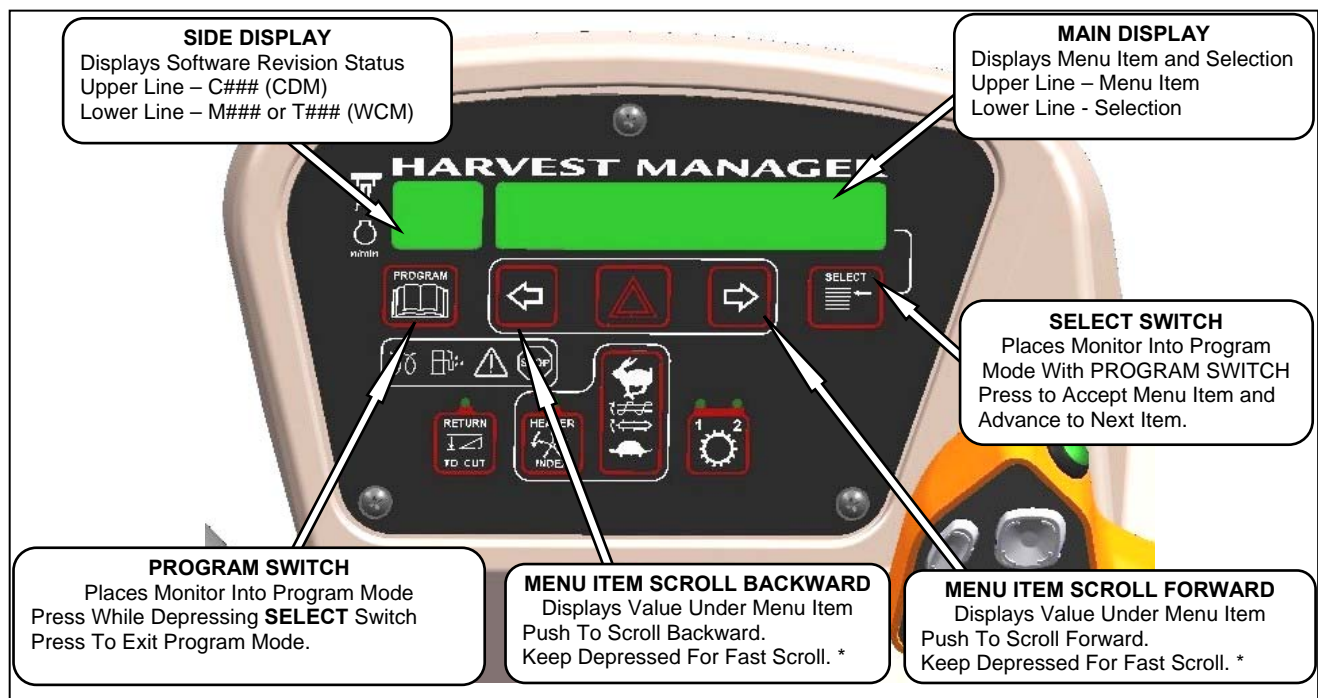

* Fast scroll applies only when changing OVERLOAD PRESSURE, and TIRE SIZE.

OPERATOR'S STATION

DETAILED PROGRAMMING INSTRUCTIONS

(Key On / Engine Running or Not / Header Disengaged).
 (Press **PROGRAM** and **SELECT** on CDM to enter programming mode).

NOTE: ENGINE MUST BE RUNNING TO CALIBRATE SENSORS.

Programming Menu Flow Chart

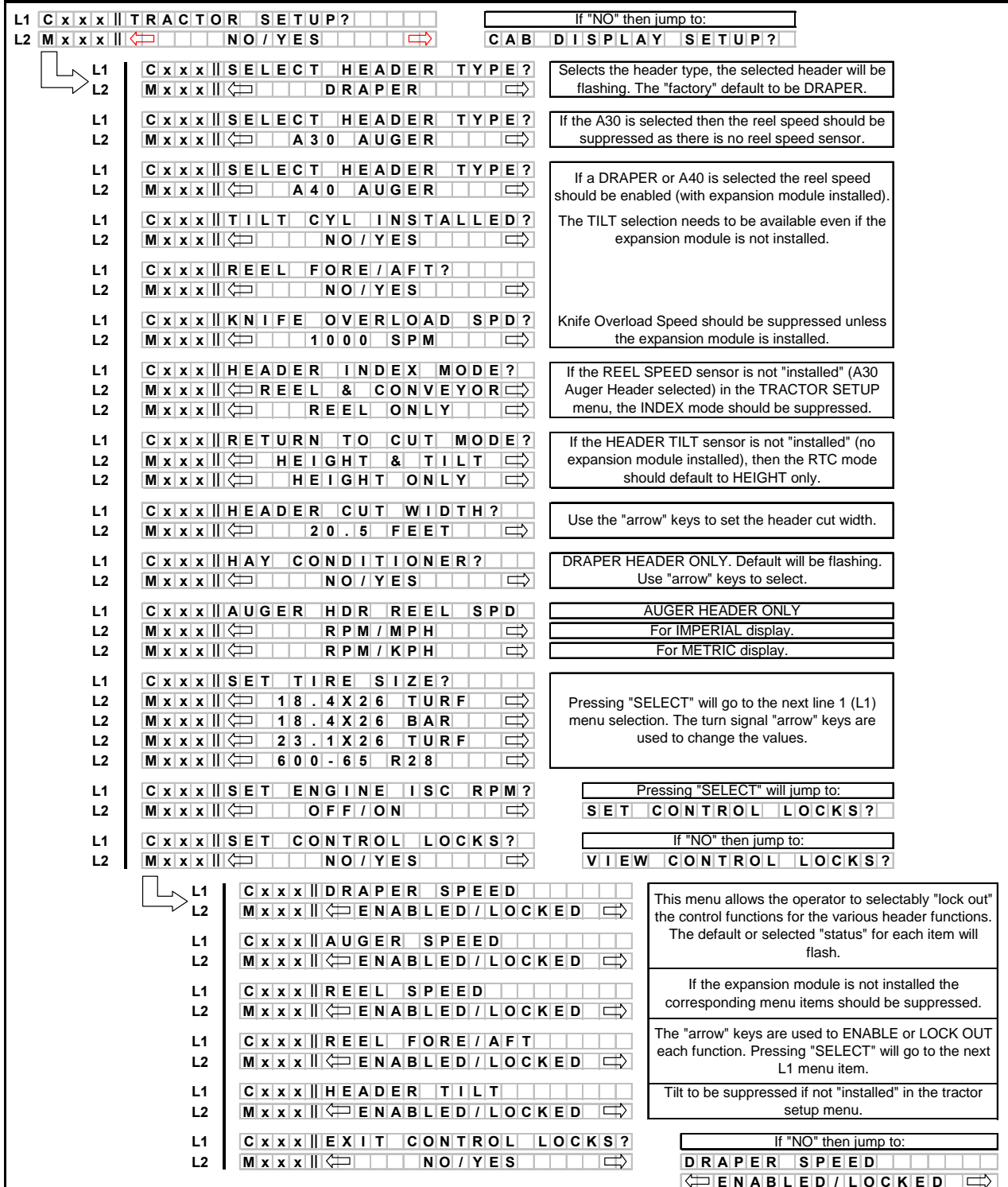

(continued next page)

OPERATOR'S STATION

L1	C x x x VIEW CONTROL LOCKS?	If "NO" then jump to:
L2	M x x x NO / YES	EXIT TRACTOR SETUP?

<table border="0" style="width: 100%;"> <tr> <td style="width: 15%; vertical-align: top;">L1</td> <td style="border: 1px solid black; padding: 2px;">C x x x DRAPER SPEED </td> </tr> <tr> <td>L2</td> <td style="border: 1px solid black; padding: 2px;">M x x x 575.1 HRS ENABLED</td> </tr> <tr> <td>L2</td> <td style="border: 1px solid black; padding: 2px;">M x x x 648.6 HRS LOCKED</td> </tr> </table> <table border="0" style="width: 100%;"> <tr> <td style="width: 15%; vertical-align: top;">L1</td> <td style="border: 1px solid black; padding: 2px;">C x x x AUGER SPEED </td> </tr> <tr> <td>L2</td> <td style="border: 1px solid black; padding: 2px;">M x x x 575.1 HRS ENABLED</td> </tr> <tr> <td>L2</td> <td style="border: 1px solid black; padding: 2px;">M x x x 648.6 HRS LOCKED</td> </tr> </table> <table border="0" style="width: 100%;"> <tr> <td style="width: 15%; vertical-align: top;">L1</td> <td style="border: 1px solid black; padding: 2px;">C x x x REEL SPEED </td> </tr> <tr> <td>L2</td> <td style="border: 1px solid black; padding: 2px;">M x x x 575.1 HRS ENABLED</td> </tr> <tr> <td>L2</td> <td style="border: 1px solid black; padding: 2px;">M x x x 648.6 HRS LOCKED</td> </tr> </table> <table border="0" style="width: 100%;"> <tr> <td style="width: 15%; vertical-align: top;">L1</td> <td style="border: 1px solid black; padding: 2px;">C x x x REEL FORE / AFT </td> </tr> <tr> <td>L2</td> <td style="border: 1px solid black; padding: 2px;">M x x x 575.1 HRS ENABLED</td> </tr> <tr> <td>L2</td> <td style="border: 1px solid black; padding: 2px;">M x x x 648.6 HRS LOCKED</td> </tr> </table> <table border="0" style="width: 100%;"> <tr> <td style="width: 15%; vertical-align: top;">L1</td> <td style="border: 1px solid black; padding: 2px;">C x x x HEADER TILT </td> </tr> <tr> <td>L2</td> <td style="border: 1px solid black; padding: 2px;">M x x x 575.1 HRS ENABLED</td> </tr> <tr> <td>L2</td> <td style="border: 1px solid black; padding: 2px;">M x x x 648.6 HRS LOCKED</td> </tr> </table> <table border="0" style="width: 100%;"> <tr> <td style="width: 15%; vertical-align: top;">L1</td> <td style="border: 1px solid black; padding: 2px;">C x x x EXIT VIEW LOCKOUTS?</td> <td style="width: 45%; border: 1px solid black; padding: 2px;">If "NO" then jump to:</td> </tr> <tr> <td>L2</td> <td style="border: 1px solid black; padding: 2px;">M x x x NO / YES </td> <td style="border: 1px solid black; padding: 2px;">DRAPER SPEED </td> </tr> </table>	L1	C x x x DRAPER SPEED	L2	M x x x 575.1 HRS ENABLED	L2	M x x x 648.6 HRS LOCKED	L1	C x x x AUGER SPEED	L2	M x x x 575.1 HRS ENABLED	L2	M x x x 648.6 HRS LOCKED	L1	C x x x REEL SPEED	L2	M x x x 575.1 HRS ENABLED	L2	M x x x 648.6 HRS LOCKED	L1	C x x x REEL FORE / AFT	L2	M x x x 575.1 HRS ENABLED	L2	M x x x 648.6 HRS LOCKED	L1	C x x x HEADER TILT	L2	M x x x 575.1 HRS ENABLED	L2	M x x x 648.6 HRS LOCKED	L1	C x x x EXIT VIEW LOCKOUTS?	If "NO" then jump to:	L2	M x x x NO / YES	DRAPER SPEED	<p>When the control lock outs are viewed, the lower display line (L2) will show the engine hours and either ENABLED or LOCKED to indicate the present status along with the engine hours at which time the function was either ENABLED or LOCKED.</p> <p>Using the "arrow" keys allows the operator to select the various functions. Pressing "SELECT" will go to the EXIT VIEW LOCKOUTS? menu selection.</p> <p>If any of the HDR ANGLE / KNIFE SPEED or REEL SPEED sensors are not "installed" (no expansion module or A30 Auger header selected, they should be suppressed.</p>	
L1	C x x x DRAPER SPEED																																					
L2	M x x x 575.1 HRS ENABLED																																					
L2	M x x x 648.6 HRS LOCKED																																					
L1	C x x x AUGER SPEED																																					
L2	M x x x 575.1 HRS ENABLED																																					
L2	M x x x 648.6 HRS LOCKED																																					
L1	C x x x REEL SPEED																																					
L2	M x x x 575.1 HRS ENABLED																																					
L2	M x x x 648.6 HRS LOCKED																																					
L1	C x x x REEL FORE / AFT																																					
L2	M x x x 575.1 HRS ENABLED																																					
L2	M x x x 648.6 HRS LOCKED																																					
L1	C x x x HEADER TILT																																					
L2	M x x x 575.1 HRS ENABLED																																					
L2	M x x x 648.6 HRS LOCKED																																					
L1	C x x x EXIT VIEW LOCKOUTS?	If "NO" then jump to:																																				
L2	M x x x NO / YES	DRAPER SPEED																																				

L1	C x x x EXIT TRACTOR SETUP?	If "NO" then jump to:
L2	M x x x NO / YES	TILT CYL INSTALLED?

L1	C x x x CAB DISPLAY SETUP?	If "NO" then jump to:
L2	M x x x NO / YES	CALIBRATE SENSORS?

<table border="0" style="width: 100%;"> <tr> <td style="width: 15%; vertical-align: top;">L1</td> <td style="border: 1px solid black; padding: 2px;">C x x x DISPLAY LANGUAGE?</td> </tr> <tr> <td>L2</td> <td style="border: 1px solid black; padding: 2px;">M x x x ENGLISH </td> </tr> <tr> <td>L2</td> <td style="border: 1px solid black; padding: 2px;">M x x x ESPANOL </td> </tr> <tr> <td>L2</td> <td style="border: 1px solid black; padding: 2px;">M x x x RUSSIAN </td> </tr> </table> <table border="0" style="width: 100%;"> <tr> <td style="width: 15%; vertical-align: top;">L1</td> <td style="border: 1px solid black; padding: 2px;">C x x x DISPLAY UNITS?</td> </tr> <tr> <td>L2</td> <td style="border: 1px solid black; padding: 2px;">M x x x IMPERIAL </td> </tr> <tr> <td>L2</td> <td style="border: 1px solid black; padding: 2px;">M x x x METRIC </td> </tr> </table> <table border="0" style="width: 100%;"> <tr> <td style="width: 15%; vertical-align: top;">L1</td> <td style="border: 1px solid black; padding: 2px;">C x x x CDM BUZZER VOLUME</td> </tr> <tr> <td>L2</td> <td style="border: 1px solid black; padding: 2px;">M x x x </td> </tr> </table> <table border="0" style="width: 100%;"> <tr> <td style="width: 15%; vertical-align: top;">L1</td> <td style="border: 1px solid black; padding: 2px;">C x x x CDM BACKLIGHTING</td> </tr> <tr> <td>L2</td> <td style="border: 1px solid black; padding: 2px;">M x x x </td> </tr> </table> <table border="0" style="width: 100%;"> <tr> <td style="width: 15%; vertical-align: top;">L1</td> <td style="border: 1px solid black; padding: 2px;">C x x x CDM CONTRAST</td> </tr> <tr> <td>L2</td> <td style="border: 1px solid black; padding: 2px;">M x x x </td> </tr> </table> <table border="0" style="width: 100%;"> <tr> <td style="width: 15%; vertical-align: top;">L1</td> <td style="border: 1px solid black; padding: 2px;">C x x x EXIT DISPLAY SETUP?</td> <td style="width: 45%; border: 1px solid black; padding: 2px;">If "NO" then jump to:</td> </tr> <tr> <td>L2</td> <td style="border: 1px solid black; padding: 2px;">M x x x NO / YES </td> <td style="border: 1px solid black; padding: 2px;">DISPLAY LANGUAGE?</td> </tr> </table>	L1	C x x x DISPLAY LANGUAGE?	L2	M x x x ENGLISH	L2	M x x x ESPANOL	L2	M x x x RUSSIAN	L1	C x x x DISPLAY UNITS?	L2	M x x x IMPERIAL	L2	M x x x METRIC	L1	C x x x CDM BUZZER VOLUME	L2	M x x x	L1	C x x x CDM BACKLIGHTING	L2	M x x x	L1	C x x x CDM CONTRAST	L2	M x x x	L1	C x x x EXIT DISPLAY SETUP?	If "NO" then jump to:	L2	M x x x NO / YES	DISPLAY LANGUAGE?	<p>Use the "arrow" keys to change the default language. Pressing "SELECT" goes to the next L1 menu selection.</p> <p>The "arrow" keys are used to select between IMPERIAL or METRIC. The default value will be displayed first.</p> <p>The "arrow" keys are used to change the CDM buzzer volume, CDM backlighting or the CDM contrast, with the bar graph indicating the relative level for each item. When "SELECT" is pressed the program goes to the EXIT DISPLAY SETUP? menu selection.</p>	
L1	C x x x DISPLAY LANGUAGE?																																	
L2	M x x x ENGLISH																																	
L2	M x x x ESPANOL																																	
L2	M x x x RUSSIAN																																	
L1	C x x x DISPLAY UNITS?																																	
L2	M x x x IMPERIAL																																	
L2	M x x x METRIC																																	
L1	C x x x CDM BUZZER VOLUME																																	
L2	M x x x																																	
L1	C x x x CDM BACKLIGHTING																																	
L2	M x x x																																	
L1	C x x x CDM CONTRAST																																	
L2	M x x x																																	
L1	C x x x EXIT DISPLAY SETUP?	If "NO" then jump to:																																
L2	M x x x NO / YES	DISPLAY LANGUAGE?																																

L1	C x x x CALIBRATE SENSORS?	If "NO" then jump to:
L2	M x x x NO / YES	DIAGNOSTIC MODE?

<table border="0" style="width: 100%;"> <tr> <td style="width: 15%; vertical-align: top;">L1</td> <td style="border: 1px solid black; padding: 2px;">C x x x TO CALIBRATE SELECT</td> </tr> <tr> <td>L2</td> <td style="border: 1px solid black; padding: 2px;">M x x x HEADER HEIGHT </td> </tr> <tr> <td>L2</td> <td style="border: 1px solid black; padding: 2px;">M x x x HEADER TILT </td> </tr> <tr> <td>L2</td> <td style="border: 1px solid black; padding: 2px;">M x x x STOP & EXIT </td> </tr> </table> <table border="0" style="width: 100%;"> <tr> <td style="width: 15%; vertical-align: top;">L1</td> <td style="border: 1px solid black; padding: 2px;">C x x x HEIGHT SENSOR CAL</td> </tr> <tr> <td>L2</td> <td style="border: 1px solid black; padding: 2px;">M x x x RAISE HDR TO START</td> </tr> </table> <table border="0" style="width: 100%;"> <tr> <td style="width: 15%; vertical-align: top;">L1</td> <td style="border: 1px solid black; padding: 2px;">C x x x CALIBRATING HEIGHT</td> </tr> <tr> <td>L2</td> <td style="border: 1px solid black; padding: 2px;">M x x x RAISE HEADER HOLD</td> </tr> <tr> <td>L2</td> <td style="border: 1px solid black; padding: 2px;">M x x x RAISE HEADER DONE</td> </tr> </table> <table border="0" style="width: 100%;"> <tr> <td style="width: 15%; vertical-align: top;">L1</td> <td style="border: 1px solid black; padding: 2px;">C x x x HEIGHT SENSOR CAL</td> </tr> <tr> <td>L2</td> <td style="border: 1px solid black; padding: 2px;">M x x x PRESS LOWER HEADER</td> </tr> </table> <table border="0" style="width: 100%;"> <tr> <td style="width: 15%; vertical-align: top;">L1</td> <td style="border: 1px solid black; padding: 2px;">M x x x CALIBRATING HEIGHT</td> </tr> <tr> <td>L2</td> <td style="border: 1px solid black; padding: 2px;">M x x x LOWER HEADER HOLD</td> </tr> <tr> <td>L2</td> <td style="border: 1px solid black; padding: 2px;">M x x x HT SENSOR COMPLETE</td> </tr> </table>	L1	C x x x TO CALIBRATE SELECT	L2	M x x x HEADER HEIGHT	L2	M x x x HEADER TILT	L2	M x x x STOP & EXIT	L1	C x x x HEIGHT SENSOR CAL	L2	M x x x RAISE HDR TO START	L1	C x x x CALIBRATING HEIGHT	L2	M x x x RAISE HEADER HOLD	L2	M x x x RAISE HEADER DONE	L1	C x x x HEIGHT SENSOR CAL	L2	M x x x PRESS LOWER HEADER	L1	M x x x CALIBRATING HEIGHT	L2	M x x x LOWER HEADER HOLD	L2	M x x x HT SENSOR COMPLETE	<p>The operator can select any of the two items requiring calibration or to STOP & EXIT the menu.</p> <p>When a function is activated, the display will indicate the function being calibrated. HOLD will flash until the system has completed reading in the signal with the header fully raised.</p> <p>DONE will flash and prompt the operator to COMPLETE the sensor calibration by lowering the header.</p>	
L1	C x x x TO CALIBRATE SELECT																													
L2	M x x x HEADER HEIGHT																													
L2	M x x x HEADER TILT																													
L2	M x x x STOP & EXIT																													
L1	C x x x HEIGHT SENSOR CAL																													
L2	M x x x RAISE HDR TO START																													
L1	C x x x CALIBRATING HEIGHT																													
L2	M x x x RAISE HEADER HOLD																													
L2	M x x x RAISE HEADER DONE																													
L1	C x x x HEIGHT SENSOR CAL																													
L2	M x x x PRESS LOWER HEADER																													
L1	M x x x CALIBRATING HEIGHT																													
L2	M x x x LOWER HEADER HOLD																													
L2	M x x x HT SENSOR COMPLETE																													

(continued next page)

OPERATOR'S STATION

L1	C x x x TO CALIBRATE SELECT	The menu will display the last item selected when the calibration routine is completed.	
L2	M x x x ← HEADER HEIGHT →		
L1	C x x x TO CALIBRATE SELECT	If the HEADER TILT option in the TRACTOR SETUP is set to NO then only HEIGHT should be available as a menu selection for calibration.	
L2	M x x x ← HEADER HEIGHT →		
L2	M x x x ← HEADER TILT →		
L1	M x x x HDR TILT SENSOR CAL		
L2	M x x x EXTEND TLT TO START		
L1	C x x x CALIBRATING TILT		
L2	M x x x EXTEND TILT HOLD		
L2	M x x x EXTEND TILT DONE		
L1	M x x x HDR TILT SENSOR CAL		
L2	M x x x PRESS RETRACT TILT		
L1	C x x x CALIBRATING TILT	If "NO" then jump to: TO CALIBRATE SELECT	
L2	M x x x RETRACT TILT HOLD		
L2	M x x x HDR TILT COMPLETE		
L1	C x x x TO CALIBRATE SELECT	If "NO" then jump to: TO CALIBRATE SELECT	
L2	M x x x ← HEADER TILT →		
L2	M x x x ← STOP & EXIT →		
L1	C x x x EXIT CALIBRATION?	If "NO" then jump to: TO CALIBRATE SELECT	
L2	M x x x ← NO / YES →		
L1	C x x x DIAGNOSTIC MODE?	If "NO" then jump to: TRACTOR SETUP?	
L2	M x x x ← NO / YES →		
↙	L1	C x x x VIEW ERROR CODES?	If "NO" then jump to: ENTER SENSOR SETUP?
	L2	M x x x ← NO / YES →	
↙	L1	C x x x VIEW TRACTOR CODES?	If "NO" then jump to: ENTER SENSOR SETUP?
	L2	M x x x ← NO / YES →	
	L1	1 1 2 3 4 . 5 HRS 1 2 3 ← →	The last 10 distinct error codes are stored along with the code #, Exxx, engine hours and number of occurrences. The "arrow" keys are used to cycle between codes.
	L2	E 4 7 SENSOR VOLTS LOW	
	L1	2 1 2 3 4 . 5 HRS 1 2 3 ← →	
	L2	E 7 1 LOW HYDRAULIC OIL	
	L1	C x x x EXIT TRACTOR CODES?	If "NO" then jump to: VIEW TRACTOR CODES?
	L2	M x x x ← NO / YES →	
L1	C x x x ENTER SENSOR SETUP?	If "NO" then jump to: READ SENSOR INPUTS?	
L2	M x x x ← NO / YES →		
↙	L1	C x x x HEADER HT SENSOR	The operator can select each sensor and selectively enable or disable the sensor in the event of a sensor malfunction.
	L2	M x x x ← ENABLE / DISABLE →	
	L1	C x x x HEADER TILT SENSOR	If no expansion module or an A30 auger header is selected, the corresponding menu items should be suppressed.
	L2	M x x x ← ENABLE / DISABLE →	
	L1	C x x x KNIFE SPEED SENSOR	
	L2	M x x x ← ENABLE / DISABLE →	When "SELECT" is pressed the program goes to the EXIT SENSOR SETUP? selection.
	L1	C x x x REEL SPEED SENSOR	
	L2	M x x x ← ENABLE / DISABLE →	
	L1	C x x x EXIT SENSOR SETUP?	If "NO" then jump to: KNIFE SPEED SENSOR Or to the first sensor "installed"
	L2	M x x x ← NO / YES →	

(continued next page)

OPERATOR'S STATION

L1	C x x x READ SENSOR INPUTS?	If "NO" then jump to:
L2	M x x x <input type="button" value="←"/> NO / YES <input type="button" value="→"/>	ACTIVATE FUNCTIONS?
L1	C x x x SENSOR INPUT <input type="button" value="←"/> <input type="button" value="→"/>	For diagnostic purposes each sensors input signal can be read.
L2	M x x x HDR HEIGHT 3 . 5 9 V	
L1	C x x x SENSOR INPUT <input type="button" value="←"/> <input type="button" value="→"/>	If no expansion module or an A30 auger header is selected, the corresponding menu items should be suppressed.
L2	M x x x HEADER ANGLE 1 . 8 4 V	
L1	C x x x SENSOR INPUT <input type="button" value="←"/> <input type="button" value="→"/>	When "SELECT" is pressed the program goes to the EXIT READ SENSORS? menu selection.
L2	M x x x KNIFE SPEED 1 2 3 HZ	
L1	C x x x SENSOR INPUT <input type="button" value="←"/> <input type="button" value="→"/>	Adds a selection to be able to read in the wheel speed frequency.
L2	M x x x WHEEL SPEED 1 2 3 HZ	
L1	C x x x EXIT READ SENSORS?	If "NO" then jump to:
L2	M x x x <input type="button" value="←"/> NO / YES <input type="button" value="→"/>	SENSOR INPUT <input type="button" value="←"/> <input type="button" value="→"/> HDR HEIGHT 3 . 5 9 V
L1	C x x x SENSOR INPUT <input type="button" value="←"/> <input type="button" value="→"/>	If a sensor has been disabled "SENSOR" will be flashing in the area where the input reading would have been.
L2	M x x x HDR HEIGHT SENSOR	
L1	C x x x SENSOR INPUT <input type="button" value="←"/> <input type="button" value="→"/>	If no expansion module or an A30 auger header is selected, the corresponding menu items should be suppressed.
L2	M x x x HEADER ANGLE SENSOR	
L1	C x x x SENSOR INPUT <input type="button" value="←"/> <input type="button" value="→"/>	
L2	M x x x KNIFE SPEED SENSOR	
L1	C x x x SENSOR INPUT <input type="button" value="←"/> <input type="button" value="→"/>	
L2	M x x x REEL SPEED SENSOR	
L1	C x x x ACTIVATE FUNCTIONS?	If "NO" then jump to:
L2	M x x x <input type="button" value="←"/> NO / YES <input type="button" value="→"/>	EXIT DIAGNOSTICS?
L1	C x x x ACTIVATE FUNCTIONS?	For diagnostic purposes each header function can be activated by using the "arrow" keys on the CDM. When "SELECT" is pressed the program will go to the next function that can be activated.
L2	M x x x HEADER <input type="button" value="←"/> DOWN / UP <input type="button" value="→"/>	
L1	C x x x ACTIVATE FUNCTIONS?	If the HEADER TILT cylinder or the REEL FORE / AFT valve is not installed under the TRACTOR SETUP menu then the ACTIVATE FUNCTIONS menu selection for these items should be suppressed.
L2	M x x x REEL <input type="button" value="←"/> DOWN / UP <input type="button" value="→"/>	
L1	C x x x ACTIVATE FUNCTIONS?	
L2	M x x x HDR TILT <input type="button" value="←"/> IN / OUT <input type="button" value="→"/>	
L1	C x x x ACTIVATE FUNCTIONS?	
L2	M x x x KNIFE DRIVE ON <input type="button" value="→"/>	
L1	C x x x ACTIVATE FUNCTIONS?	ACTIVATE HYD PURGE - This is to allow the operator to purge the air from a new or changed pump system.
L2	M x x x DRAPER / AUGER ON <input type="button" value="→"/>	
L1	C x x x ACTIVATE FUNCTIONS?	Pressing and holding the right hand "arrow" button activates a predetermined timed purge cycle. Releasing pressure on the switch or a completed cycle (timed out) will jump to the PURGE CYCLE ENDED ENDED menu selection.
L2	M x x x REEL <input type="button" value="←"/> FORE / AFT <input type="button" value="→"/>	
L1	C x x x ACTIVATE HYD PURGE?	If "NO" then jump to:
L2	M x x x <input type="button" value="←"/> NO / YES <input type="button" value="→"/>	
L1	C x x x TO ACTIVATE PURGE	If "NO" then jump to:
L2	M x x x <input type="button" value="←"/> PRESS AND HOLD <input type="button" value="→"/>	
L1	C x x x PURGE CYCLE STARTED	
L2	M x x x <input type="button" value="←"/> PRESS AND HOLD <input type="button" value="→"/>	
L1	C x x x PURGE CYCLE ENDED	
L2	M x x x	
L1	C x x x PURGE CYCLE ENDED	If "NO" then jump to:
L2	M x x x <input type="button" value="←"/> NO EXIT YES <input type="button" value="→"/>	
L1	C x x x EXIT FUNCTION MENU?	If "NO" then jump to:
L2	M x x x <input type="button" value="←"/> NO / YES <input type="button" value="→"/>	
L1	C x x x EXIT DIAGNOSTICS?	If "NO" then jump to:
L2	M x x x <input type="button" value="←"/> NO / YES <input type="button" value="→"/>	

OPERATOR'S STATION

5.18.6 Engine Error Codes

The CDM displays "Error Codes" when there is a fault with one of the several sensors that monitor and control engine operation, to assist the operator or technician in locating a specific problem with engine operation. Refer to the Appendix for the "Error Codes".

5.18.7 CDM & WCM Fault Codes

The CDM displays "Fault Codes" when there is a fault with one of the several sensors that monitor and control windrower operation, to assist the operator or technician in locating a specific problem with the windrower. Refer to the Appendix for the "Fault Codes".

OPERATOR'S STATION

6 OPERATION

6.1 OWNER/OPERATOR RESPONSIBILITIES















CAUTION

- It is your responsibility to read and understand this manual completely before operating the windrower. Contact your dealer if an instruction is not clear to you.
- Follow all safety messages in the manual and on safety signs on the machine.
- Remember that YOU are the key to safety. Good safety practices protect you and the people around you.
- Before allowing anyone to operate the windrower, for however short a time or distance, make sure they have been instructed in its safe and proper use.
- Review the manual and all safety related items with all operators annually.
- Be alert for other operators not using recommended procedures or not following safety precautions. Correct these mistakes immediately, before an accident occurs.
- Do not modify the machine. Unauthorized modifications may impair the function and/or safety and affect machine life.
- The safety information given in this manual does not replace safety codes, insurance needs, or laws governing your area. Be sure your machine meets the standards set by these regulations.













6.2 SYMBOL DEFINITIONS

The following symbols are used to depict functions or reactions at the various instruments and controls. Learn the meaning of these symbols before operating the Windrower.

6.2.1 Engine Functions

	Electrical Power-Accessories		Engine Stop
	Engine Coolant Temperature		Engine Throttle
	Engine Glow Plugs		Engine Urgent Stop
	Engine Malfunction		Fast
	Engine Rpm n/min		Slow
	Engine Run		Water In Fuel
	Engine Start		

6.2.2 Windrower Operating Symbols

	Turn Signals		Windshield Wiper
	Hazard Warning Lights		Seat Height Up
F	Forward		Seat Height Down
N	Neutral		Seat Fore And Aft
R	Reverse		Beacon
	Headlights Low Beam/Road Lights		Seat Back Fore And Aft
	Headlights High Beam/Road Lights		
	Work Light		Cab Temperature Control
	Lighter		

OPERATOR'S STATION

Windrower Operating Symbols (cont'd)

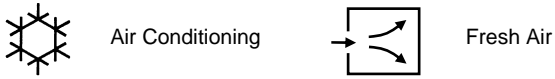

Air Conditioning



Fresh Air



Blower

6.2.3 Header Functions



Program



Header Tilt Up



Header Index



Header Down



Return To Cut



Header Up



Conveyor Speed



Header Tilt Down



Increase



Decrease



Reel Speed



Deck Shift



Reel Down



Header Engage



Reel Forward



Header Disengage



Reel Up



Push Down Header Disengage



Reel Rearward



Pull Up Header Engage



Display Select

WINDROWER OPERATION

6.3 WINDROWER OPERATION

6.3.1 Operational Safety

Follow these safety precautions:



CAUTION

- Wear close fitting clothing and protective shoes with slip resistant soles.
- Remove foreign objects from the machine and surrounding area.
- Carry with you any protective clothing and personal safety devices that **COULD** be necessary through the day. Don't take chances.

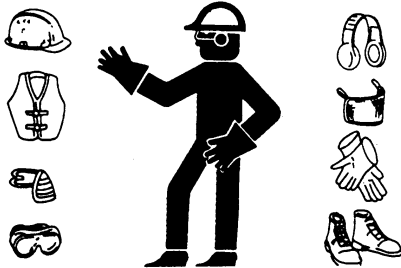

- You may need:
 - a hard hat
 - protective glasses or goggles
 - heavy gloves
 - respirator or filter mask
 - wet weather gear
- Protect against noise. Wear a suitable hearing protective device such as ear muffs or ear plugs to protect against objectionable or uncomfortable loud noises.
- Follow all safety and operational instructions given in your Operator's Manuals. If you do not have a windrower and/or combine manual, get one from your dealer and read it thoroughly.
- Never attempt to start the engine or operate the machine except from the operator's seat.



- Check the operation of all controls in a safe clear area before starting work.
- Stop engine and remove key before adjusting or removing plugged material from the machine. A child or even a pet could engage the drive.
- Check for excessive vibration and unusual noises. If there is any indication of trouble, shut down and inspect the machine. Follow proper shutdown procedure. Refer to Section 6.3.5.3 Shutdown Procedure.
- Operate only in daylight or good artificial light.

6.3.2 Break-In Period

The windrower is ready for normal operation. However there are several items to check and watch out for during the first 150 hours.

6.3.2.1 Engine

- Operate engine at moderate load and avoid extremely heavy or light loading for longer than 5 minutes.
- Avoid unnecessary idling. If engine will be idling for longer than 5 minutes after reaching operating temperature, turn key OFF to stop engine.
- Check engine oil level frequently. Watch for any signs of leakage. If oil must be added, refer to Section 7.8.2 Oil Level.

NOTE

During the break-in period, a higher than usual oil consumption should be considered normal.

NOTE

If windrower must be driven in cold weather (below freezing), let engine idle for 3 minutes, and then operate at moderate speed until oil has warmed up.

- Watch for temperature rising beyond normal operating range. Check that coolant level at reserve tank (mounted next to radiator) stays between HOT and COLD marks on tank. Refer to Section 7.8.7.1 Cooling System. If overheating problems occur, check for coolant leaks.

OPERATOR'S STATION

6.3.2.2 Windrower

IMPORTANT

Until you become familiar with the sound and feel of your new windrower, be extra alert and attentive.



DANGER

Before investigating an unusual sound or attempting to correct a problem, place GSL in N-DETENT, shut off engine, and remove key.

Perform the checks and service specified in Section 7.13.1 Break-In Inspection.

6.3.3 Pre-Season Check

- a. Perform the following safety checks at the beginning of each operating season:



CAUTION

- Review the Operator's Manual to refresh your memory on safety and operating recommendations.
- Review all safety signs and other decals on the windrower and note hazard areas.
- Be sure all shields and guards are properly installed and secured. Never alter or remove safety equipment.
- Be sure you understand and have practiced safe use of all controls. Know the capacity and operating characteristics of the machine.
- Store a properly stocked first aid kit and charged fire extinguisher on the windrower.

- b. Perform the following checks:

1. Drain off excess hydraulic oil added for storage. Refer to Section 7.11.2 Changing Hydraulic Oil.
2. Remove plastic bags and/or tape from all sealed openings (air cleaner intake, exhaust pipe, fuel tank).
3. Charge battery and install. Be sure terminals are clean and cables are connected securely.
4. Adjust tension on A/C compressor belt. See Section 7.8.8.3 Tension.
5. Cycle A/C switch to distribute A/C refrigerant oil.

- c. Perform annual maintenance. See Section 7.13 Maintenance Schedule.

6.3.4 Daily Check

- a. Check the machine for leaks or any parts that are missing, broken, or not working correctly.

NOTE:

Use proper procedure when searching for pressurized fluid leaks. Refer to Section 7.11.7 Hoses and Lines.

- b. Clean the windows and mirrors to be sure of good visibility in all directions. Stand on the platform to access the rear window. Hold onto the hand-holds on the cab front corners and stand on the header anti-slip strips to wash the front window.
- c. Clean all lights and reflective surfaces to maintain visibility to others.
- d. Perform Daily maintenance. Refer to Section 7.13.2 Interval Maintenance.

WINDROWER OPERATION

6.3.5 Engine Operation

6.3.5.1 Starting



DANGER

- Avoid possible injury or death from a runaway machine.
- Do not start engine by shorting across starter terminals. Machine will start in gear and move if normal starting circuitry is bypassed.
- This machine has safety devices which prevent the engine from starting. The ground speed lever is in N-DETENT, the steering wheel is locked in the neutral position, and the header drive switch is in the OFF position. Under no circumstances are these circuits to be deliberately rewired or misadjusted so that the engine can be started with controls out of neutral.
- Never start engine by shorting across starter terminals. Machine will start with drive engaged and move if normal starting circuitry is bypassed.
- Never try to start engine with someone under or near machine.
- Start engine only from operator's seat with controls in neutral. NEVER start engine while standing on ground. Machine will start in gear and move if normal starting circuitry is bypassed.
- Before starting engine, be sure there is plenty of ventilation to avoid asphyxiation.

IMPORTANT

Do not tow machine to start engine. Damage to hydrostatic drives will result.



WARNING

Before starting engine, securely fasten your seat belt and ensure trainer's seat belt is fastened if occupied. The seat belt can help insure your safety if it is used and maintained.



- Move GSL (A) into **N-DETENT**.
- Turn steering wheel until it locks.
- Fasten seat belt.
- Push header drive switch (B) to off.
- Normal Start - engine temperature above 60°F (16°C):
 - Set throttle (C) to start position – fully back.

IMPORTANT

The machine gauges and instruments provide important information about machine operation and condition. Familiarize yourself with the gauges and monitor them carefully during start-up operation. Refer to Section 5.15, Engine Controls/Gauges.

- Turn ignition key (D) to **RUN** position.



CAUTION

Be sure the area is clear of other persons, pets etc. before proceeding.

- Single loud tone sounds, engine warning lights illuminate and CDM displays HDR DISENGAGED or HEADER ENGAGED and IN PARK.
- Turn ignition key to **START** position until engine starts and then release key. Tone ceases and warning lights go out. CDM displays programmed header data for 5 seconds if attached and then returns to previous display.

(continued next page)

OPERATOR'S STATION

IMPORTANT

Do not operate starter for longer than 15 seconds at a time. If engine does not start, wait at least two minutes before trying again. After the third 15 second crank attempt, allow solenoid to cool for 10 minutes before further cranking attempts. If engine still does not start, refer to Trouble Shooting section.



WARNING

If starter engages with steering wheel unlocked, ground speed lever out of neutral, or header clutch engaged, **DO NOT START ENGINE**. See your dealer.



- f. Cold Start - engine temperature below 40°F (5°C).
 1. Set throttle (C) to start position – fully back (low idle).
 2. Turn key (D) to **RUN**.
 3. Grid heater light (E) on CDM will cycle on/off/on after 2 seconds for a pre-set length of time. The operating period for the glow plug light will change depending engine temperature.
 4. When grid heater light goes out, turn key to **START** and crank engine until it starts. Leave throttle at **IDLE**.
 5. If engine fails to start, repeat steps 1 to 4.
 6. Engine will cycle through a period where it appears to labour.

NOTE

Throttle is non-responsive during this time as engine is in "WARM UP" mode. This mode will last from 30 seconds to 3 minutes depending on temperature. After engine has stabilized and idling normally, throttle becomes active.

IMPORTANT

Do not operate engine above 1500 rpm until engine temperature gauge is above 100°F (40°C).

IMPORTANT

Do not operate starter for longer than 15 seconds at a time. If engine does not start, wait at least two minutes before trying again. After the third 15 second crank attempt, allow solenoid to cool for 10 minutes before further cranking attempts. If engine still does not start, refer to Section 8 Trouble Shooting.



WARNING

If starter engages with steering wheel unlocked, ground speed lever out of neutral, or header clutch engaged, **DO NOT START ENGINE**. See your windrower dealer.

6.3.5.2 Engine Warm-Up



Allow engine to run with throttle lever (C) at or near low idle position until temperature reaches approximately 100°F (40°C).

WINDROWER OPERATION

6.3.5.3 Shutdown



CAUTION

Be sure windrower is safely parked on a flat, level surface, header on the ground and the neutral lock/brakes are engaged.

IMPORTANT

Before stopping engine, run at low idle for approximately five minutes to cool hot engine parts (and allow turbocharger to slow down while engine oil pressure is available).

- a. Turn key counter-clockwise to OFF position.

6.3.5.4 Fueling



WARNING

To avoid personal injury or death from explosion or fire, do not smoke or allow flame or sparks near fuel tank when refuelling.



Never refuel the windrower when the engine is hot or running.

- a. Stop the windrower and remove key.
- b. Stand on platform to access the fuel tank filler pipe.

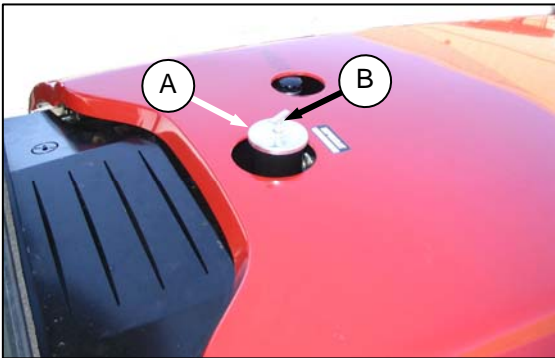

- c. Clean the area around the filler cap (A).
- d. Turn cap handle (B) counterclockwise until loose and remove cap.
- e. Fill tank with approved fuel as per table.

FUEL	SPEC	SULPHUR (by weight)	WATER & SEDIMENT (by weight)	CETANE NO.	LUBRI CITY
Diesel Grade No.2	ASTM D-975	As Per Spec	As Per Spec	As Per Spec	As Per Spec
Diesel Grade No.1 & 2 mix *	n/a	1% Max. 0.5% Max. Preferred	0.1% Max.	45-55 Cold Weather/ High Alt.	460 HFRR

- f. Replace fuel tank cap (A) and turn cap handle (B) clockwise until snug.

NOTE

Fill fuel tank daily, preferably at the end of the day's operation to help prevent condensation in the tank. Tank Capacity is 97 U.S. Gallons (378 liters).

IMPORTANT

Do not fill tank completely; space is required for expansion. A filled tank could overflow if exposed to a rise in temperature, such as direct sunlight.

IMPORTANT

Do not allow tank to empty. Running out of fuel can cause air locks and/or contamination of the fuel system. Refer to Section 7.8.5 Fuel System for priming procedures.

6.3.5.5 Engine Temperature



The normal engine operating temperature range is 180°-225°F (82°-107°C), and is indicated on the CDM display. If the temperature exceeds 230°F (110°C), an ongoing intermittent tone will be heard and the CDM will flash "ENGINE TEMP". Stop the engine immediately and determine cause. The tone will stop and the CDM will return to normal when the temperature drops below 225°F (107°C).

OPERATOR'S STATION

6.3.5.6 Engine Oil Pressure

There is no gauge or display for engine oil pressure. The nominal engine oil pressure is 10 psi (69 kPa) at low idle, and 55.1 psi (380 kPa) at maximum rated speed. If the oil pressure drops below 7.5 psi (52 kPa), a continuous loud tone will sound and the CDM display will flash "ENGINE OIL PRESS". Shutdown the engine immediately if warning occurs while operating or if it continues for more than a few seconds after engine startup.

6.3.5.7 Electrical

The electrical system voltage is displayed on the CDM when selected with the select button on the GSL handle or the select switch on the CDM. The display indicates the condition of the battery and alternator. Refer to table.

IGNITION	ENGINE	READING	INDICATED CONDITION
On	Running	13.8-15.0	Normal
		> 16.0 See Note	Regulator Out of Adjustment.
	<12.5 See Note	Alternator Not Working or Regulator Out of Adjustment.	
	Shutdown	12.0	Battery Normal.

Note: Display flashes voltage reading with single loud tone. Repeats every 30 minutes until condition fixed.

6.3.5.8 Engine Integrated Speed Control (ISC)

The engine operating speed can be programmed to enable the windrower to operate at 2400 rpm (200 below maximum) without significantly affecting the ground or header speeds. This is useful in where operating loads are reduced such as in light crop conditions which do not require the maximum engine rpm. Reduced engine speed lowers fuel consumption, noise levels, and exhaust emissions in addition to reducing engine wear.

Programming instructions are given in Section 5.18.5 Cab Display Monitor (CDM) Programming. The programmed engine speed is activated when the header is engaged.

6.3.5.9 Engine Warning Lights

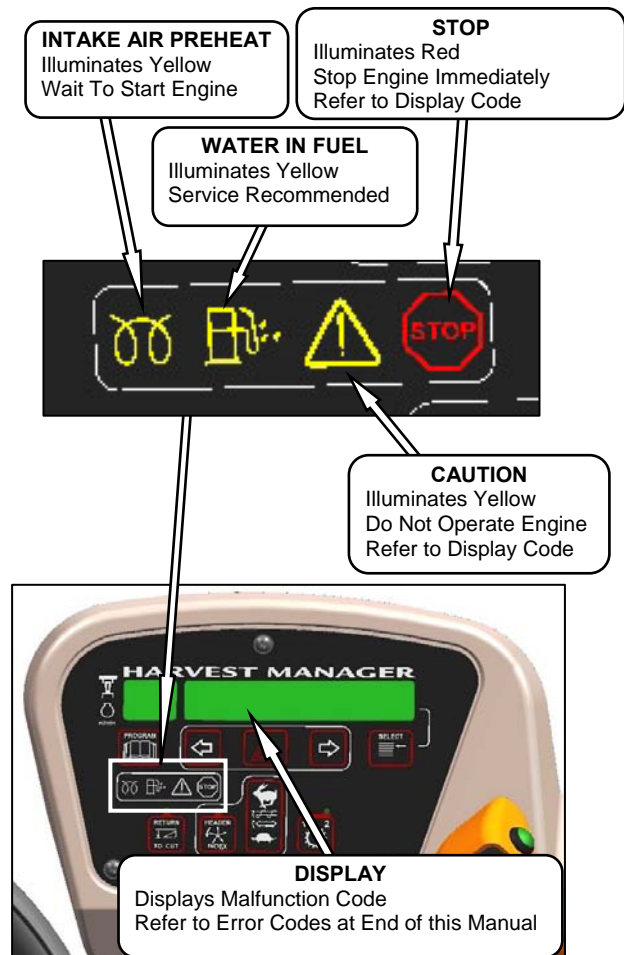

There are four engine warning lights that illuminate if abnormal conditions occur while the engine is running. The engine warning lights should not be illuminated under normal operating conditions.

WINDROWER OPERATION

6.3.6 Driving the Windrower



WARNING

Before starting engine, securely fasten your seat belt and ensure trainer's seat belt is fastened if occupied. The seat belt can help insure your safety if it is used and maintained.



WARNING

- Avoid driving the machine with header removed. Removing header decreases the weight on drive wheels, reducing steering control.



- If necessary to drive machine with header removed, use transmission "field speed" range, do not exceed 1500 rpm engine speed and avoid loose gravel and slopes.
- Never use windrower as a towing vehicle when header is removed, except as instructed in Section 6.3.8.2 Towing Header with Windrower. There is insufficient weight on the drive wheels to provide steering control.
- Because of windrower shape characteristics, a roll-over protected (ROPS) cab is not required. If operating with header removed, be aware that the cab structure will not withstand a roll-over.



CAUTION

HYDROSTATIC STEERING

The machine is steered hydrostatically, that is, turning the steering wheel varies the hydraulic flow to one drive wheel relative to the other drive wheel. The reaction of this type of steering is different than conventional steering mechanisms.

IMPORTANT

With the engine running, moving the ground speed lever out of N-DETENT unlocks steering. Any movement of steering wheel will then cause the machine to move, even if the ground speed lever has not been moved forward or rearward from the neutral position.

Hydrostatic steering is more sensitive than mechanical steering.

Steering is opposite to normal when driving in reverse.

The brakes are only on when the GSL is in N-DETENT and the steering wheel is centered and locked.



DANGER

- Never move ground speed lever or steering wheel until you are sure all bystanders have cleared the area.

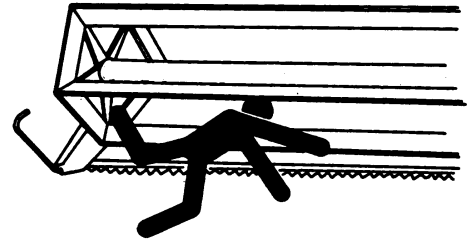

- Be sure area is clear before making turns, ends of header travel in a large arc.
- Check the operation of all controls in a safe, clear area before starting work. Be sure you know the capacity and operating characteristics of this machine.



- Do not allow riders in or on the machine.
- Operate only while seated in the operator's position.
- Never attempt to get on or off a moving windrower.
- Avoid sudden starts and stops.

(continued next page)

OPERATOR'S STATION

- Avoid inclines, ditches and fences.
- Do not rapidly accelerate or decelerate when turning
- Reduce speed before turning, crossing slopes, or travelling over rough ground.
- Do not allow anyone to stand behind the machine while operating. Foreign objects may be forcibly ejected.

6.3.6.1 Ingress/Egress



CAUTION

- To provide more secure hand and foot mobility, preventing slipping and possible injury, always face the windrower and use the hand rail when dismounting (or mounting).
- Never attempt to get on or off a moving windrower.
- Before leaving the operator's seat for any reason:
 - Park on level ground if possible.
 - Be sure ground speed lever is in N-DETENT and steering wheel is locked in the straight-ahead position.
 - Fully lower header and reel.
 - Disengage header drives.
 - Stop engine and remove key from ignition. A child or even a pet could engage an idling machine.
 - Turn off wiper.
 - Turn off lights unless required for inspection purposes.
 - Release seat belt.
 - Raise armrest and steering wheel for easier exit and re-entry.
- Lock the cab door when leaving the windrower unattended. (When the door is locked, it can still be opened from inside the cab.)

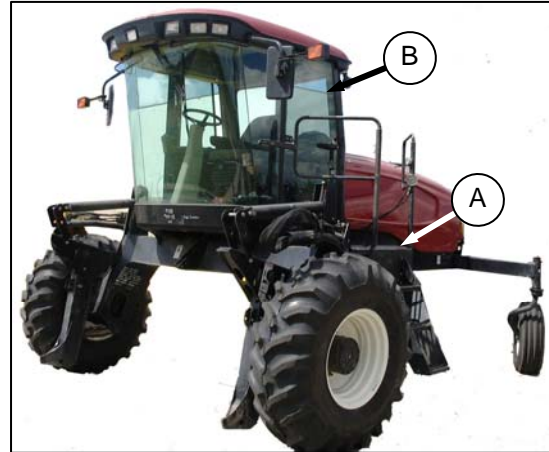

- a. A swing away platform and stair (A) are provided on the LH side of the windrower to accommodate access to the operator's station as well as several maintenance tasks.
- b. A door (B) is provided for cab entry and exit.

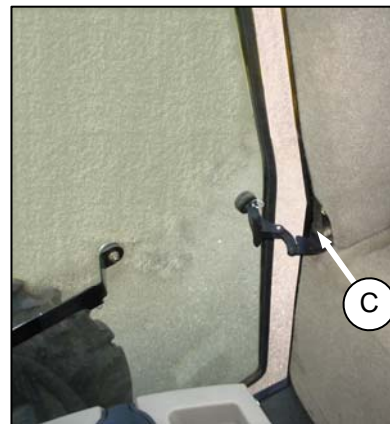

- c. The RH window has an overcenter swing-out latch (C) that "unpins" for emergency exit.

WINDROWER OPERATION

6.3.6.2 Operation

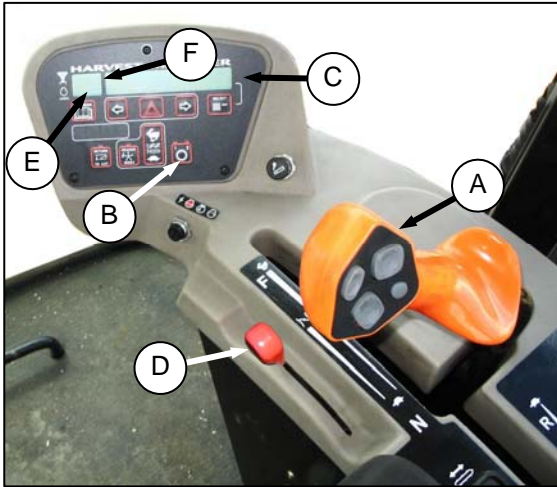

- Place GSL (A) in **N-DETENT**. Engine can be running.
- Fasten seat belt.
- Start engine. Refer to Section 6.3.5.1 Starting.
- Set ground speed range switch (B) to either **2** for road speed (0-16 mph (0-25.7 km/h)), or **1** for field speed (0-11 mph (17.7 km/h)). CDM will display an engine status at (C).
- Slowly push throttle (D) to full forward (operating speed). CDM should display 2600-2650 RPM at (E).



CAUTION

Check again to be sure all bystanders have cleared the area.

- Slowly move the GSL (A) forward to desired speed which will be displayed at (F).



CAUTION

Operate both steering wheel and ground speed lever slowly for familiarization. Avoid the common tendency of new operators to over-steer.

NOTE

The windrower can be equipped with an automatic steering system for use in the field. The Auto-Steer is available as an option and can be installed by an Auto-Steer dealer. The GSL has been pre-wired at the factory with a switch. Also see Section 9.14 AUTO-STEER.

6.3.6.2.1 Reverse



WARNING

Back up slowly. Steering is opposite to normal when reversing. Hold steering wheel at the bottom and turn wheel in direction you want the rear of the machine to travel.



- Set ground speed-range switch (B) to **1**.
- Move throttle lever (D) to a mid-range position.

NOTE

Reversing in low speed-range and at reduced engine speed is recommended since steering will be less sensitive than at higher speed settings.



CAUTION

Check again to be sure all bystanders have cleared the area.

- Move the GSL (A) rearward to desired speed.
- Steer as shown.

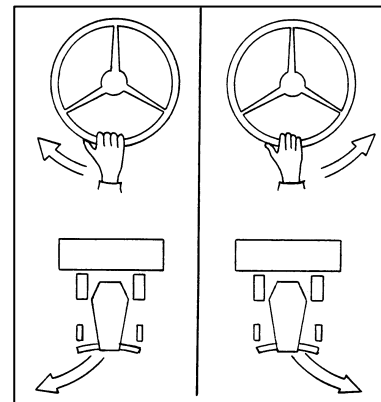

OPERATOR'S STATION

6.3.6.2.2 Spin Turn

Hydrostatic steering gives the operator significantly more manoeuvrability than mechanical steering. To make a spin turn, refer to illustration and proceed as follows:



CAUTION

Be sure area is clear before making turns. Although windrower pivots "on the spot", ends of header travel in a large arc.



- Move the GSL (A) out of N-DETENT towards the seat and hold.
- Slowly turn the steering wheel in the desired direction of turn. The windrower will pivot between the drive wheels.
- To stop the turn, slowly turn the steering wheel back to its centered position.
- To increase the turn radius, slowly move the GSL away from neutral. Remember that this will increase ground speed as well.
- To stop the turn, move GSL back to neutral, and return the steering wheel to center.

6.3.6.2.3 Stopping



WARNING

Do not move ground speed lever rapidly back to neutral. Operator may be thrown forward by sudden stop. Always wear seat belt when operating windrower.



- SLOWLY** return the GSL (A) to neutral and into N-DETENT.
- Turn steering wheel until it locks.
- Move throttle lever (D) to low idle position.

NOTE

Avoid unnecessary idling. Stop engine if it will be idling for longer than 5 minutes.

- Brakes are automatically engaged when steering wheel is locked in neutral position.



CAUTION

Park on a flat, level surface, header on the ground and the ground speed lever in N-DETENT.

IMPORTANT

Before stopping engine, run at low idle for approximately five minutes to cool hot engine parts (and allow turbocharger to slow down while engine oil pressure is available).

- Turn key counter-clockwise to OFF position.

WINDROWER OPERATION

6.3.7 Adjustable Caster Tread Width (Optional)

As an option, the rear casters can be adjusted to a narrow tread width to allow loading and shipping without having to remove them. A narrow tread width also suits smaller headers by allowing more space to the uncut crop and provides more maneuverability around poles, irrigation inlets, or other obstacles. A wider tread width is useful in heavy crops that produce large windrows so that run-over is reduced.

To adjust the caster tread width, refer to the following illustrations and proceed as follows:



CAUTION

Park on a flat, level surface, header on the ground and the ground speed lever in N-DETENT position.



DANGER

Stop engine and remove key from ignition before leaving operator's seat for any reason. A child or even a pet could engage an idling machine.

- a. Raise rear of windrower slightly so that most of the weight is off the casters, using a jack or other lifting device under the frame where shown.

NOTE

Lifting device should have lifting capacity of at least 5000 lb (2270 kg).

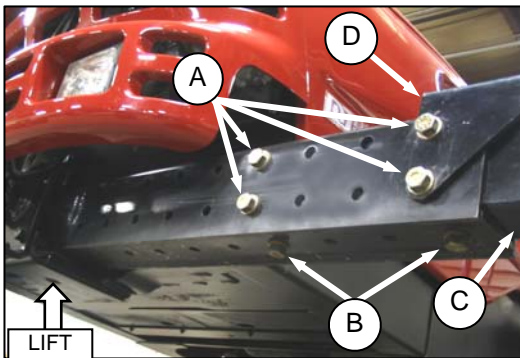

- b. Remove bolts and washers (A) and (B) from left and right sides of the walking beam.
- c. Slide walking beam extensions (C) inboard or outboard equal amounts and align holes at desired position.

NOTE

Illustration shows widest tread width adjustment.

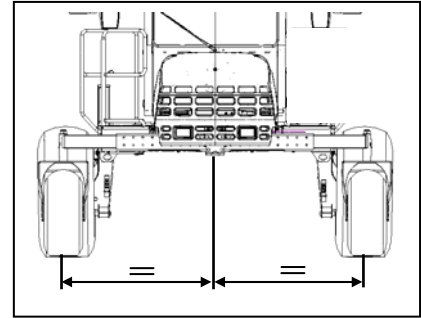

IMPORTANT

Center of tread width must be aligned with center of windrower.

- d. Position bracket (D) and install bolts (A) and (B). The two shorter bolts are installed at the back inboard locations. Torque as follows:
 1. Snug bottom bolts (B).
 2. Tighten back bolts (A) to 330 ft·lbf (447 N·m).
 3. Tighten bottom bolts (B) to 330 ft·lbf (447 N·m).
- e. Lower windrower and remove lifting device.
- f. Retorque bolts at 5 and 10 hours of operation.

OPERATOR'S STATION

6.3.8 Transporting

6.3.8.1 Driving On Road



WARNING

Collision between windrower and other vehicles may result in injury or death.



WARNING

When driving windrower on public roadways:

- Obey all highway traffic regulations in your area. Use pilot vehicles front and rear of windrower if required by law.
- Use slow moving vehicle emblem and flashing warning lights unless prohibited by law.
- If width of attached header impedes other vehicle traffic, remove header and install a MacDon approved weight box.



CAUTION

Check local laws for width regulations and lighting and marking requirements before transporting on roads.



WARNING

Do not drive windrower on a road or highway at night, or in conditions which reduce visibility, such as fog or rain. The width of the windrower may not be apparent under these conditions.



CAUTION

Operate both steering wheel and ground speed lever slowly for familiarization. Remember that steering is more sensitive when speed-range control is in Road Speed Position. Avoid the common tendency of new operators to over-steer.



- Ensure HEADER DRIVE switch is pushed to off position.
- Before driving windrower on a roadway:
 - Clean flashing amber lamps, red tail lamp and head lamps and check that they work properly.
 - Clean all reflective surfaces and slow moving vehicle emblems.
 - Adjust interior rear view mirror and clean windows.

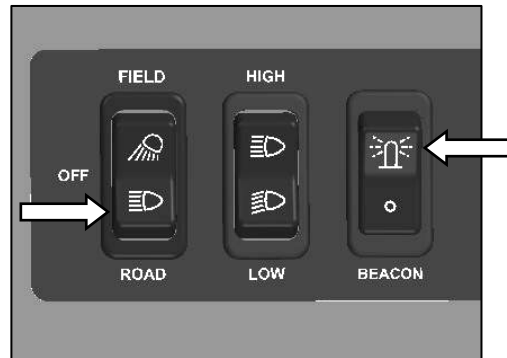

- Push LIGHT switch to ROAD position to activate lamps. .



WARNING

Always use these lamps on roads to provide warning to other vehicles. Do not use field lamps on roads, other drivers may be confused by them.

- Push BEACON switch to on to activate beacons (North America optional).

(continued next page)

WINDROWER OPERATION



- e. Press switch (A) on CDM to activate hazard lights (Export optional).
- f. Push ground speed range switch (B) for road speed. CDM will display ROAD GEAR at (C), and LED over 2 will light up.
- g. Slowly push throttle (D) to full forward (operating rpm). CDM should display 2600-2650 at (E).
- h. Slowly move the GSL (F) forward to desired ground speed which will be displayed also at (F).
- i. If towing a header, refer to Section 6.3.8.2 Towing Header with Windrower.



WARNING

To avoid serious injury or death from loss of control:

- Do not make abrupt changes in steering direction.
- Anticipate turns and steep slopes by slowing down well in advance.
- Do not rapidly accelerate or decelerate while turning.
- When travelling on steep slopes:
 - i) Move ground speed lever closer to neutral to reduce speed.
 - ii) Lower header.
 - iii) Move GROUND SPEED RANGE switch to low range.

- With header removed, steering control is reduced if weight is not added to drive wheels. If you must drive the windrower without header or MacDon weight system;
 - i) Operate in low speed range.
 - ii) Do not exceed 1500 rpm engine speed.
 - iii) Avoid loose gravel and slopes.
 - iv) Do not tow a header.
 - v) If control of machine is lost, immediately pull ground speed lever to neutral.

OPERATOR'S STATION

6.3.8.2 Towing D-Series Header with Windrower



The M100 windrower can be used to tow a MacDon Harvest Header with the Slow Speed Transport option installed, provided the Transport Drawbar and the Weight Box options are installed on the windrower. See your MacDon dealer for further information if these options are not installed on your M100 windrower.



WARNING

Harvest Header with Transport Option

The windrower without the header must not be used to tow headers due to reduced traction and possible loss of control unless the Weight Box option is installed on the windrower.



CAUTION

- To tow a header for transporting with an M100 Self Propelled Windrower, the header must be equipped with the appropriate equipment to comply with all local regulations.
- Before each towing trip, a pre-trip inspection must all be conducted to verify that all signal lighting and safety equipment is installed and functioning properly.
- Do not connect any towed implement except for:
 - 30-35' D-Series headers equipped with slow-speed transport package or
 - Header transport trailers for 20-25' D-Series headers.
- Tongue weight must not exceed 500 lbs.
- Do not exceed the specified Combined Gross Vehicle Weight (CGVW).

- To prevent machine damage and/or loss of control, it is essential that the machine be equipped such that weights are within the following limits:

		LB	KG
MAX GVW (includes mounted implements)		17,750	8,050
MAX CGVW (includes towed and mounted implements).		20,200	9,160
WEIGHT "A" ON BOTH DRIVE WHEELS	MAX	16,300	7,390
	MIN	9,150	4,150
MAX WEIGHT "B" ON BOTH CASTER TIRES		3,550	1,610

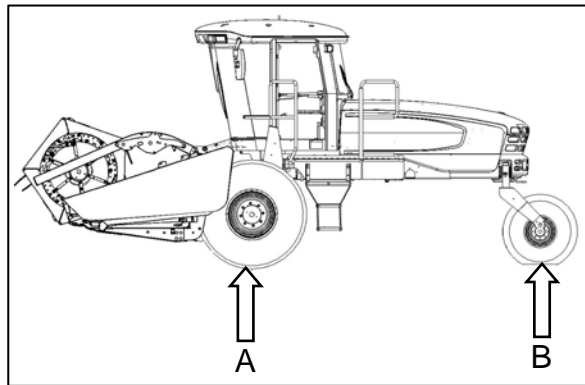

WINDROWER OPERATION

6.3.8.2.1 From Field to Transport Mode

6.3.8.2.1.1 Detach Header from Windrower

- a. Set header on the ground (field position).



DANGER

Stop engine and remove key from ignition before leaving operator's seat for any reason. A child or even a pet could engage an idling machine.

- b. Disconnect hydraulic and electrical connections:
1. Left Side - Store hydraulic hoses and electrical cable into the storage position. See Header Operator's Manual.
 2. Right side – Release the multi link and place into storage on windrower. See Header Operator's Manual.

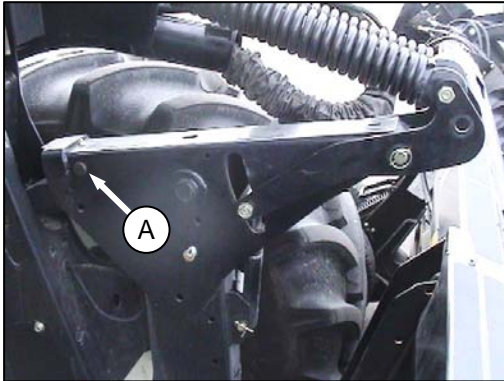

- c. Retrieve temporary lift pin from storage location on weight box and install into rear hole (A) at the top of the lift arms for additional lift height for transport wheel deployment.



DANGER

To avoid bodily injury from fall of raised header, always engage header lift cylinder stops when working on or around raised header.

- d. Raise header to full height, stop engine, and engage safety locks on lift cylinders.



- e. Deploy header slow speed transport system. See Header Operator's Manual.

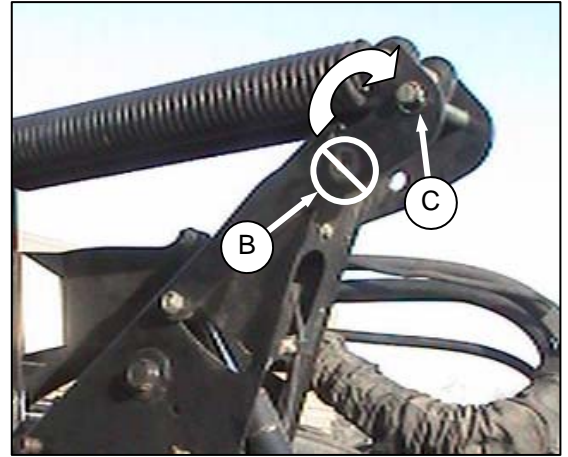

- f. Remove float pin from engaged position (B) and insert in storage location (C). Secure with lynch pin.

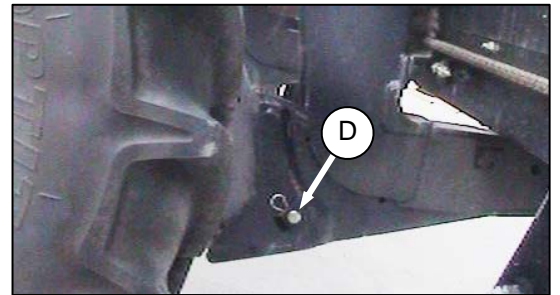

- g. Remove pins (D) from lower end of lift linkages.

NOTE

Pins (D) are also used to secure weight box to windrower linkage.

- h. Disconnect the center link as follows:

HYDRAULIC LINK – OPTION

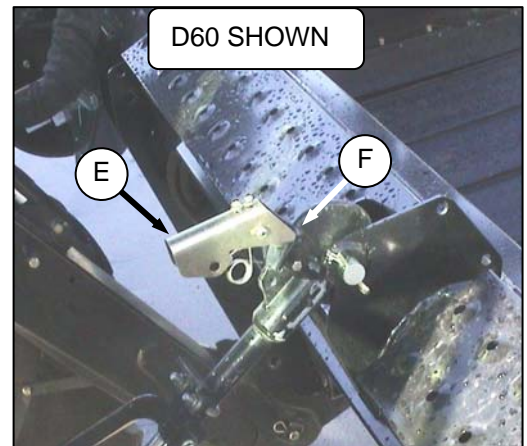

1. Pull up on latch (E) and locate latch into notch (F) on top of hook.

(continued next page)

OPERATOR'S STATION

2. Release the safety lock on the header lift cylinders.
3. Lower header down onto the transport wheels.
4. Disengage the top link from the header. Use the header tilt switch to release load on the cylinder if necessary.

MECHANICAL LINK – M150

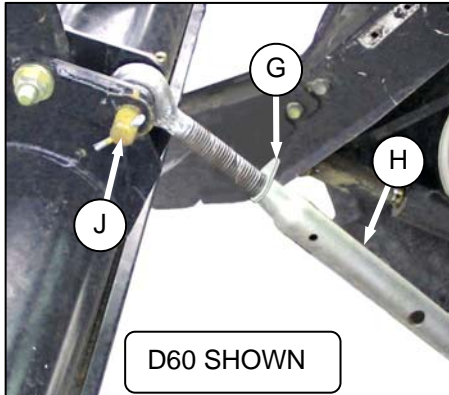

1. Loosen nut (G) and rotate barrel (H) to relieve load on link.
 2. Remove cotter pin on pin (J), and remove pin to disconnect from windrower. Re-install pin in header.
- i. Back windrower away from header.
- j. Remove tow-bar sections from storage locations on header, assemble, and attach to header. See Header Operator's Manual.

6.3.8.2.1.2 Attach Weight Box To Windrower.

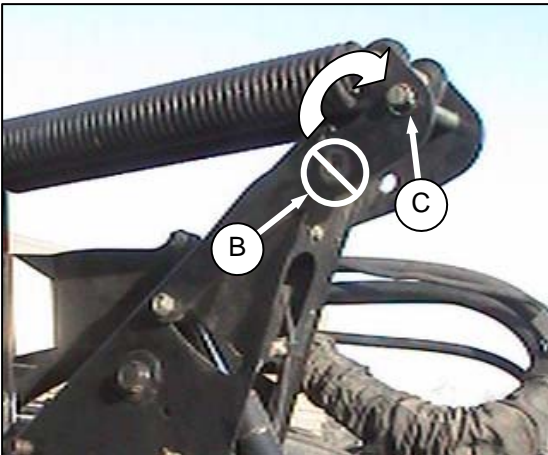

IMPORTANT

To prevent damage to the lift system when lowering header lift linkages without a header or weight box attached to windrower, ensure that float engagement pin is installed in storage location (C), and **not** installed at hole location (B).

- a. Drive windrower so that windrower lift arms are positioned into the weight box pockets.

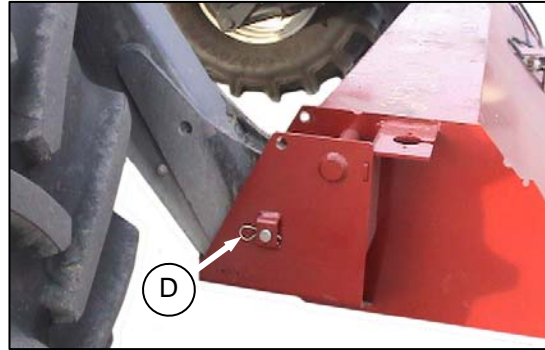

- b. Raise lift arms slightly.
- c. Stop engine and remove key.
- d. Install locking pins (D) into pockets and thru windrower header lift linkages. Secure with hairpin.

NOTE

Pins (D) were previously removed from the header lift linkage lower end.

- e. At rear of windrower, lower the drawbar bracket from field position as follows:

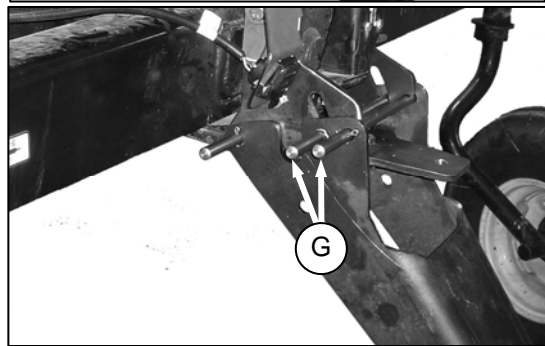
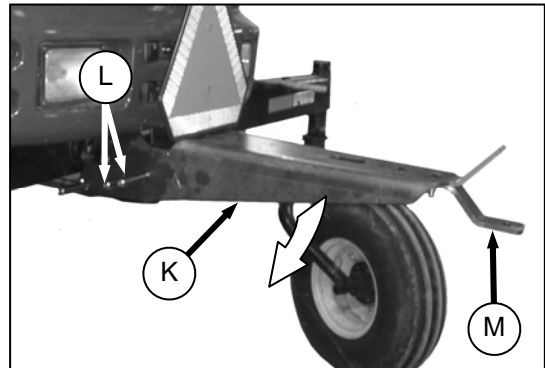

1. Hold drawbar support (K) and remove the two pins (L) at the forward end.
2. Lower support to position shown and re-install the two pins in uppermost pair of holes in support.
3. Alternate drawbar (M) can be removed if desired.

WINDROWER OPERATION

f. Attach Tow-Bar To Windrower

The M100 Transport drawbar provides approximately 12 in. (300 mm) of fore/aft movement to ease the attachment of a towed implement.

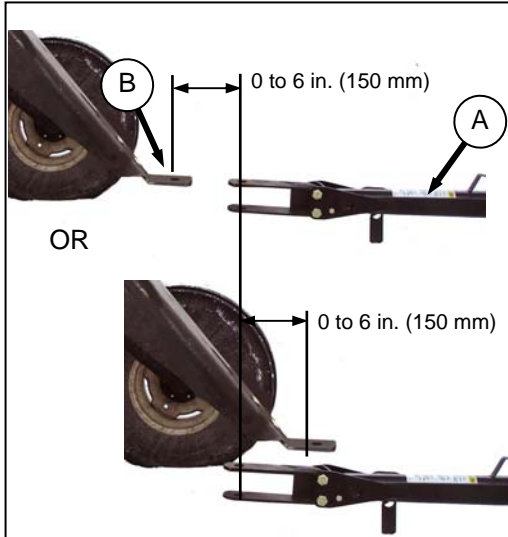

- Back the windrower up to the tow-bar (A) so that drawbar hole (B) is within 6 in. (150 mm) of the tow-bar clevis pin.
- Stop engine and remove key.

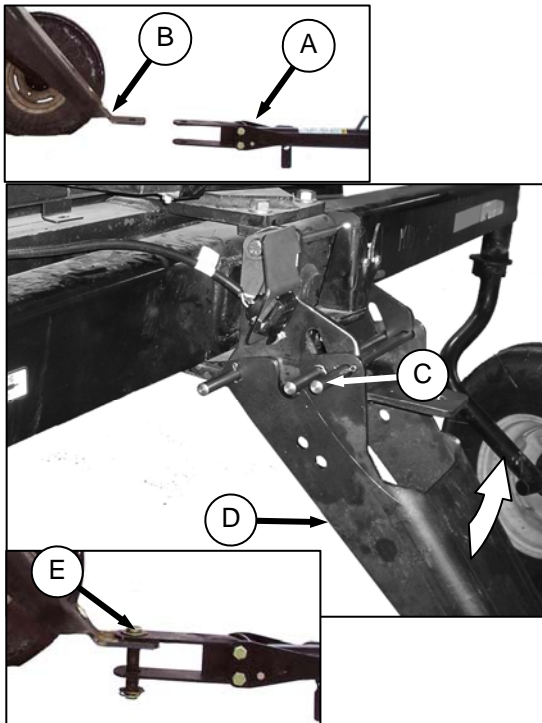

- If the tow-bar (A) is too far from the drawbar (B), remove pin (C), lift the drawbar support (D) until the tow-bar clevis aligns and then install the drawbar pin (E).

- Start engine and gently reverse the windrower until the drawbar support pivots down into transport position.
- Stop engine and remove key.
- Reinstall pin (C) to secure drawbar support, and proceed to step k.

IMPORTANT

Ensure lynch pins are secure in all three pins and that the drawbar pin is also secured by a locking pin.

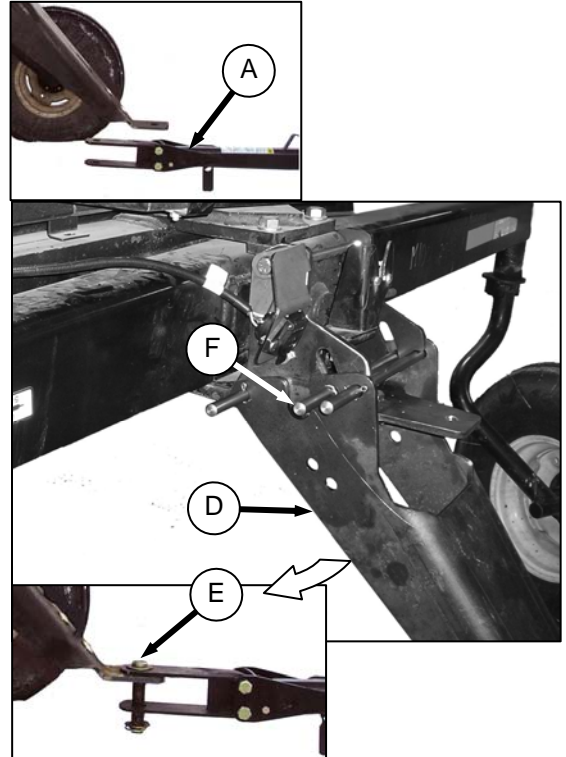

- If the tow-bar (A) is too close to the windrower, remove pin (F), lower the drawbar support (D) until the tow-bar clevis aligns and then install the drawbar pin (E).
- Start engine and gently drive the windrower forward until the drawbar support pivots up into transport position.
- Stop engine and remove key.
- Reinstall pin (F).

(continued next page)

OPERATOR'S STATION

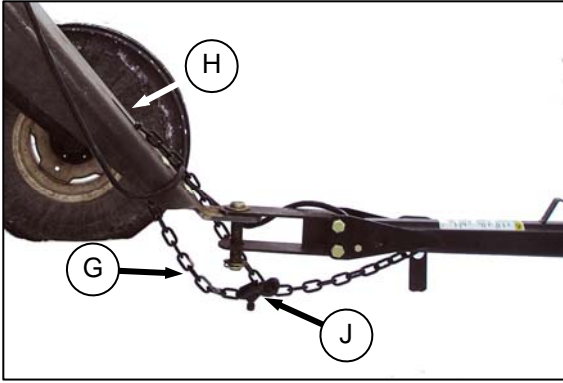

- o. Before moving the machine: double check that all pins are secure, the drawbar and hitching components are not showing signs of damage, and that all safety equipment is installed and fully functional.

- k. Connect safety chain (G) through the slot (H) in drawbar support and securely attach the hook (J) to the chain. Leave enough slack to allow the hitch to pivot.

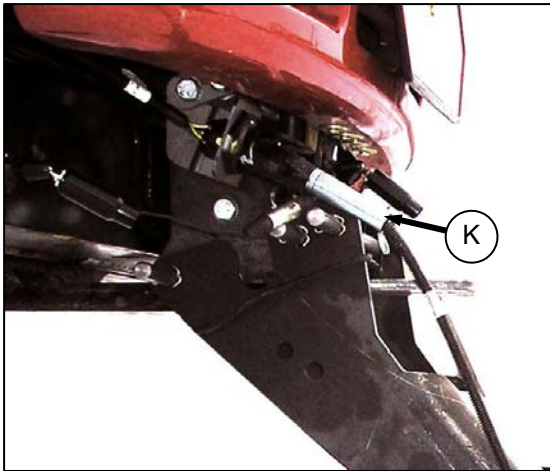

- l. At the drawbar, connect the tow-bar harness plug (K) to the receptacle on the windrower.

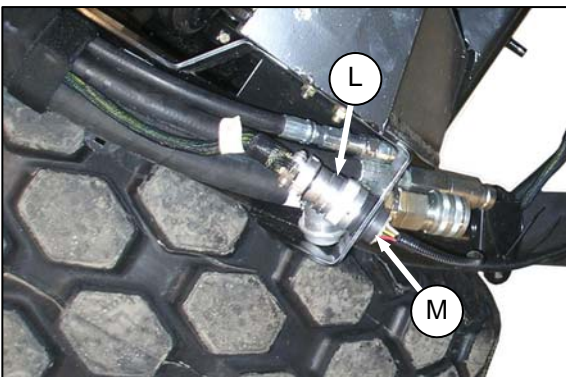

- m. At the LH float spring tower, attach connector (L) on windrower harness to towing harness receptacle (M).
- n. Confirm that the flashing amber and signal lights on header function properly.

WINDROWER OPERATION

6.3.8.2.2 From Transport Mode To Field Operation

- a. Shutdown windrower and remove key.

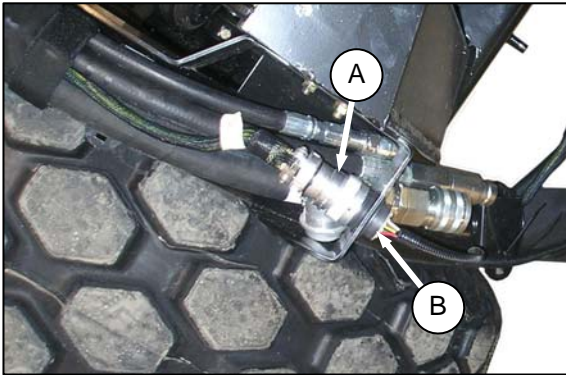

- b. Disconnect windrower harness (A) from towing harness receptacle (B) in LH float spring tower.

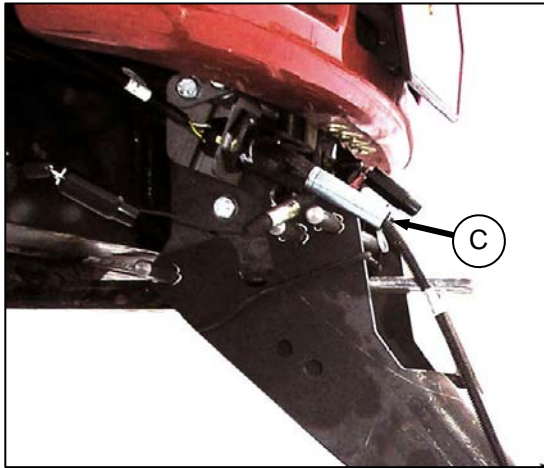

- c. Disconnect electrical harness (C) from windrower and store harness on tow-bar.

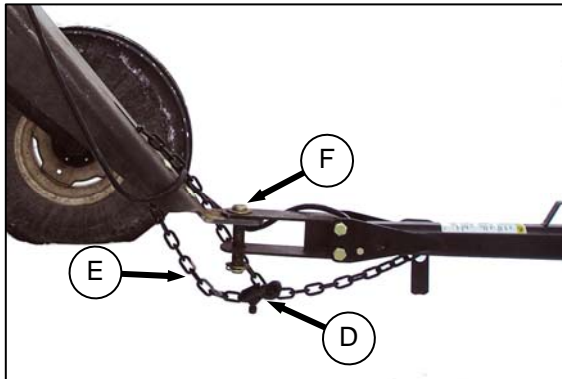

- d. Undo lock (D) and remove safety chain (E) from drawbar and remove clevis pin (F).
e. Move tow-bar off drawbar.

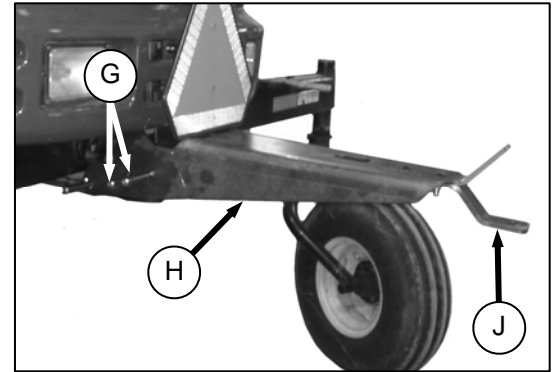
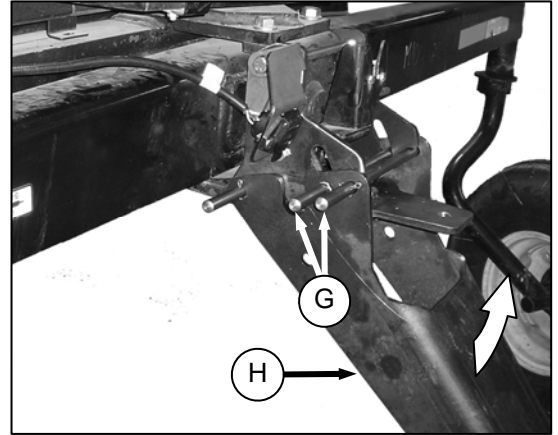

- f. At rear of windrower, remove pins (G), lift drawbar support (H) to horizontal position, and re-install pins as shown.
g. Alternate drawbar (J) is used for attaching tow behind swath roller.

IMPORTANT

Do not use alternate drawbar for any other purpose.

- h. Disassemble tow-bar and store on header. See Header Operator's Manual.

(continued next page)

OPERATOR'S STATION

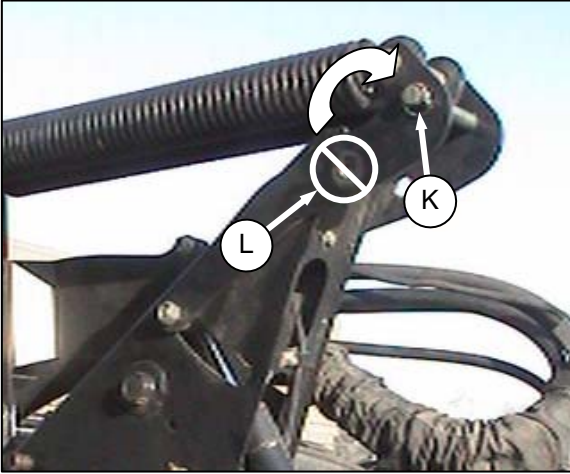

IMPORTANT

To prevent damage to the lift system when lowering header lift linkages without a header or weight box attached to windrower, ensure that float engagement pin is installed in storage location (K), and **not** installed at hole location (L).

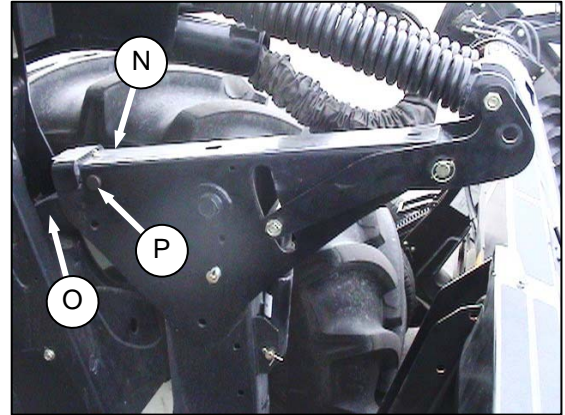

- m. Start engine and lower header to ground. Continue to retract lift cylinders so that member (N) lifts off link (O).
- n. Remove temporary lift pins (P) from lift arms and install pins into storage holes in weight box.
- o. Before operating the machine, double check that all pins are secure, and that all safety equipment is installed and fully functional.
- p. Proceed with operation of header.

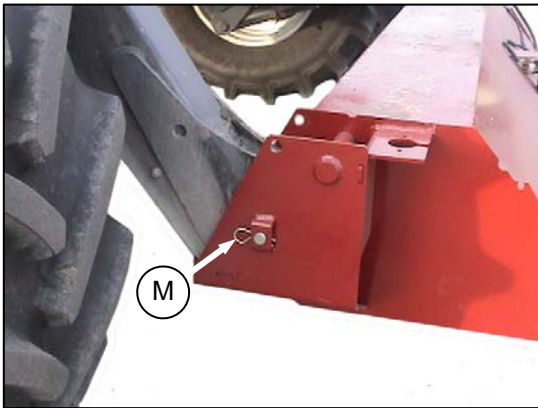

- i. Remove pins (M) securing lift linkages to weight box, and retain pins for attaching header to windrower.
- j. Lower weight box onto blocks and back away.
- k. Attach header to windrower. Refer to Section 6.5.1 Header Attachment.
- l. Convert header into field position. See Header Operator's Manual for procedure.

WINDROWER OPERATION

6.3.8.3 Towing the Windrower

In emergency situations, for example, towing out of a field or into a shop, windrower may be towed without a trailer, providing the following precautions are followed:



WARNING

A proper towing apparatus is critical to safe towing. Use the following guidelines:

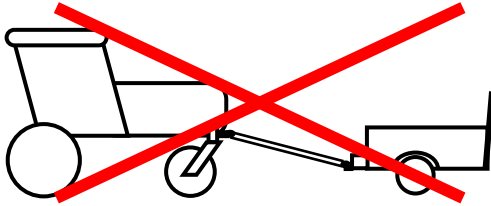

- Do not attach directly from hitch to walking beam. Slope of tow bar will not provide proper transfer of braking force to windrower, causing loss of control.
- For proper steering, towing apparatus should be attached to both left and right hand frame members and should attach to tow bar at same height as towing vehicle hitch.
- Towing apparatus should be removed for field operation, to avoid interference with windrow.

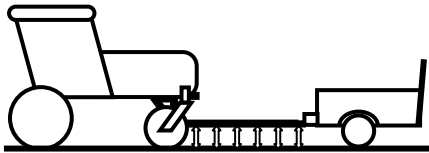
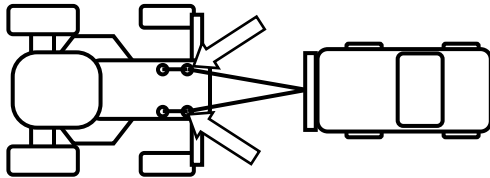

WARNING

With final drives disengaged, the windrower may roll on a sloped surface. Before disengaging final drives, attach windrower to towing vehicle. After towing, engage drives and ensure GSL is in N-DETENT before detaching from towing vehicle.

IMPORTANT

Failure to disengage final drives before towing will result in serious transmission damage.

IMPORTANT

Do not exceed 16 mph (26 km/h) when towing windrower. Do not use this towing method for normal transporting of windrower. Even with final drives disengaged, rolling speeds of more than 16 mph (26 km/h) will cause final drive gears to run at excessive speeds, possibly destroying the unit.

OPERATOR'S STATION

6.3.8.4 Final Drives

Disengage and engage final drives as follows:

- Remove the two hex bolts (A) at center of drive wheel.
- Remove cap (B) and flip over so that dished side faces in. The cap depresses a pin which disengages the gearbox.
- After towing, reverse cover (A) to re-engage final

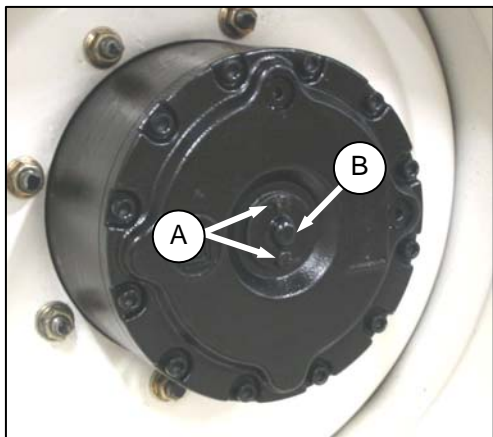

drives. Be sure plunger at center of wheel pops out to engage drive.

6.3.9 Storage

NOTE

For short term storage (3-4 weeks), it is recommended to shut off the battery disconnect switch to reduce/minimize battery drain. See 7.10.1.5 Battery Disconnect Switch.

At the end of each operating season:

- Clean the windrower thoroughly.



WARNING

Never use gasoline, naphtha or any volatile material for cleaning purposes. These materials are toxic and/can be flammable.

- Store windrower in a dry protected place.



CAUTION

Never operate engine in a closed building. Proper ventilation is required to avoid exhaust gas hazards.

- Remove the battery. Refer to Section 7.10.1.5.

- Bring to full charge and store in a cool, dry place not subject to freezing.



CAUTION

Remember when working around storage batteries that all of the exposed metal parts are "live". Never lay a metal object across the terminals because a spark and short circuit will result.

- If stored outside, always cover windrower with a waterproof tarpaulin or other protective material. This will protect the switches, instruments, tires, etc. from inclement weather.
- If no cover is available; seal air cleaner intake and exhaust pipe with plastic bags and/or waterproof tape.
- If possible, block up windrower to take weight off tires. If it is not possible to block up the machine, increase tire pressure by 25% for storage. Adjust to recommended operating pressure before next use.
- Repaint all worn or chipped painted surfaces to prevent rust.
- Lubricate the windrower thoroughly, leaving excess grease on fittings to keep moisture out of bearings. Apply grease to exposed threads and sliding surfaces of components.
- Check for worn components and repair. Tighten loose hardware and replace any missing hardware. See Specifications section for torque charts.
- Check for broken components and order replacements from your dealer. Attention to these items right away will save time and effort at beginning of next season.
- Add approved rust inhibitor to the engine oil in accordance with the manufacturer's instructions. Run engine to operating temperature to mix inhibitor with oil, unless otherwise specified.
- To prevent condensation, fill hydraulic oil reservoir to filler neck with approved hydraulic system oil. Refer to Section 7.11.1 Hydraulic Oil.
- Test engine coolant anti-freeze concentration to ensure it is sufficient to protect engine against lowest expected temperature.

HEADER OPERATION

6.4 HEADER OPERATION

The M100 Windrower is designed to use the MacDon A Series auger header with hay conditioner, and D Series Rigid Draper headers with or without hay conditioners. This section describes the attachment and detachment procedures and operating instructions for these header types.

6.4.1 Header Lift Cylinder Stops

Cylinder stops are located on both header lift cylinders on the windrower. To avoid bodily injury or death from fall of raised header, always engage cylinder stops before going under header for any reason. Engage cylinder stops as follows:

- a. Press HEADER UP switch to raise header to maximum height.

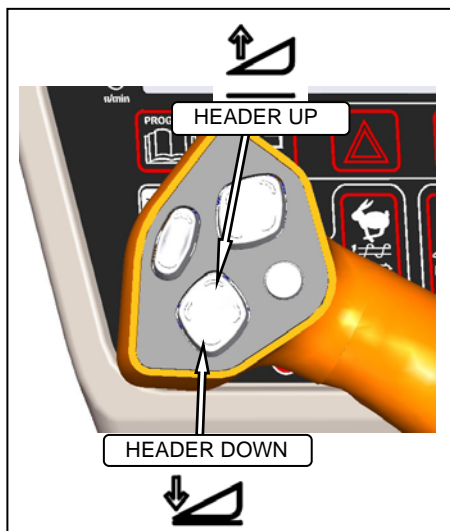

NOTE

If one end of the header does not raise fully, the lift cylinders require re-phasing. Proceed as follows:

1. Hold the up switch until both cylinders stop moving.
2. Press HEADER DOWN switch to lower the header all the way down, and continue to hold the switch for 3-4 seconds.
3. Raise the header again to full height.

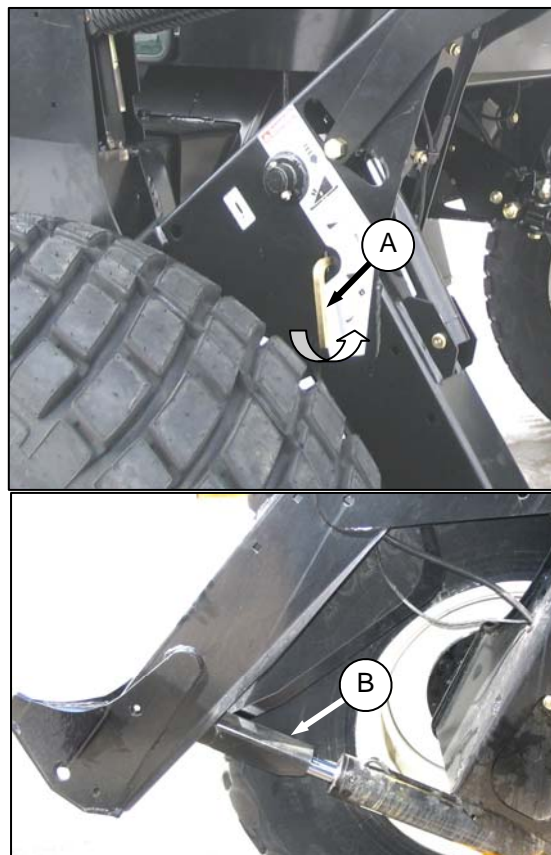

- b. Pull lever (A) and rotate toward header to release and lower cylinder stop (B) onto cylinder. Repeat for both lift cylinders.
- c. To store, turn lever (A) away from header to raise stop until lever locks into vertical position.

HEADER OPERATION

6.4.2 Header Flotation

Float is intended for cutting crops that require the cutterbar to be in contact with the ground. Optimum float is for the cutterbar to maintain contact with the ground with minimum bouncing and scooping or pushing soil.

The machine will perform best with minimum extra weight on the header.

IMPORTANT

To avoid frequent breakage of sickle components, scooping soil, or soil build-up at cutterbar in wet conditions, header float should be set as light as possible without causing excessive bouncing. When float setting is light, it may be necessary to use a slower ground speed to avoid excessive bouncing and leaving a ragged cut.

IMPORTANT

The stabilizer wheels are designed to minimize bouncing at the header ends and not “float” the header. Refer to the D60 Harvest Header / FD70 FlexDraper Operator's Manual for adjustment details.

6.4.2.1 Float Operating Guidelines

When working with the cutterbar on the ground;

- Set center link to mid-range position. Refer to Section 6.4.4 Header Angle.
- In rocky fields, adjust skid shoes down to raise guards when operating at flattest header angle to minimize scooping rocks.
- Adjust header height or adjust header angle to minimize pushing soil.

6.4.2.2 Float Adjustment

The float adjustment uses drawbolts to change the tension on the springs in the lift linkages.

- a. Check header float as follows:



CAUTION

Check to be sure all bystanders have cleared the area.

1. Start the engine.

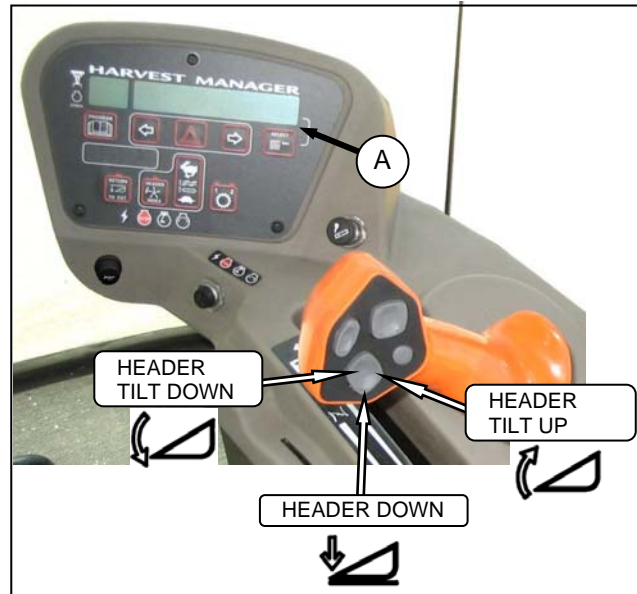

2. If hydraulic center link is installed, use the HEADER TILT SWITCHES to set center link to mid-range position (05.0 on CDM) (A).
3. Using HEADER DOWN switch, lower header fully with lift cylinders fully retracted.



DANGER

Stop engine and remove key from ignition before leaving operator's seat for any reason. A child or even a pet could engage an idling machine.

4. Shut down engine and remove key.
5. Grasp the divider rod and lift. The force to lift should be as noted in the following table, and should be approximately the same at both ends.

(continued next page)

HEADER OPERATION

HEADER	FORCE TO LIFT CUTTERBAR AT ENDS WITH LIFT CYL FULLY RETRACTED
Auger	75-85 lbf (335-380 N)
Draper	50-70 lbf (220-310 N) With Stabilizer/Transport Wheels Raised (if equipped).

3. Turn drawbolt (D) clockwise to increase float (makes header lighter) or counterclockwise to decrease float (makes header heavier).
4. Recheck the float as described on previous page.

- b. If necessary, adjust the float with the drawbolts as follows:



CAUTION

Check to be sure all bystanders have cleared the area.

1. Start engine.

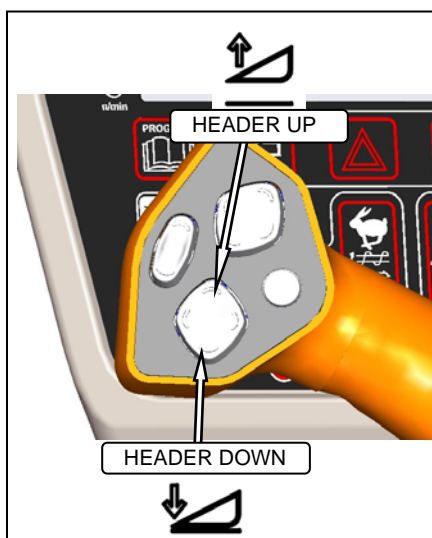

2. Using HEADER UP switch on GSL, Raise the header fully, shut down the engine, and remove the key.

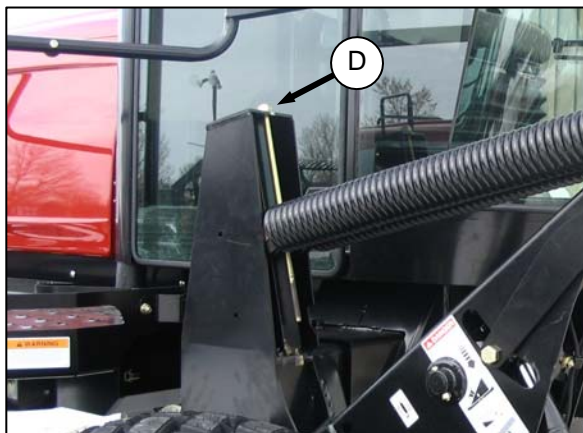

HEADER OPERATION

6.4.2.3 Leveling

The windrower linkages are factory set to provide the proper level for the header and should not normally require adjustment. If the header is not level, perform the following checks prior to adjusting the leveling linkages. The float springs are not used to level the header.

- Raise header to full height and keep HEADER UP switch depressed to ensure lift cylinders are phased.
- Check drive wheel tire pressures.
- Check and set float adjustment. Refer to previous sections.
- If header is not level after the above checks, adjust as follows:

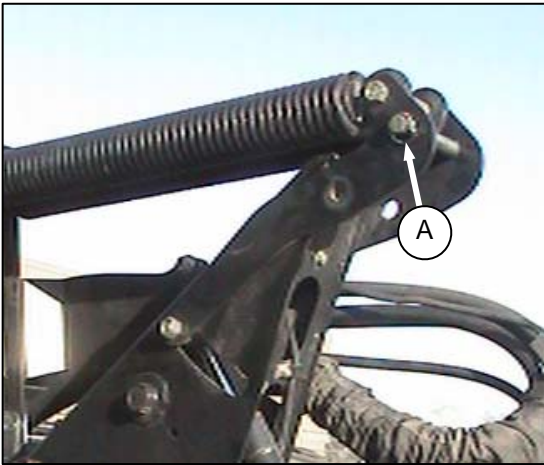

- Place float pins in locked out location (A).
- Park windrower on level ground.

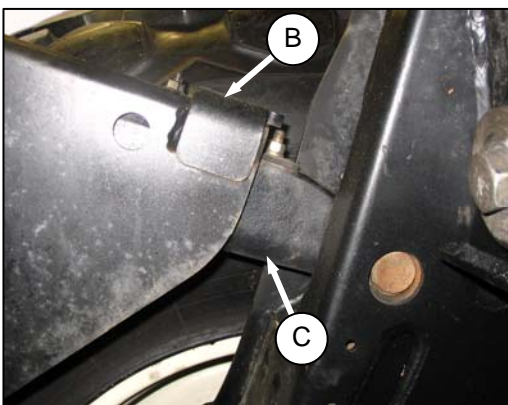

- Set header approximately 6 inches (150 mm) off ground and check that member (B) is on link (C) as shown. Note high and low end of header.

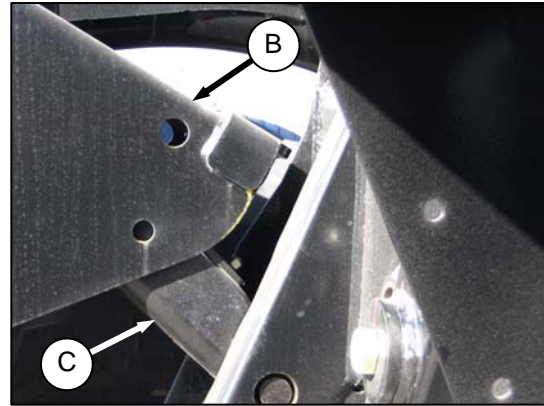

- Place wooden blocks under header cutterbar and legs.
- Lower header onto blocks so that members (B) lift off links (C). Stop engine.



DANGER

Stop engine and remove key from ignition before leaving operator's seat for any reason. A child or even a pet could engage an idling machine.

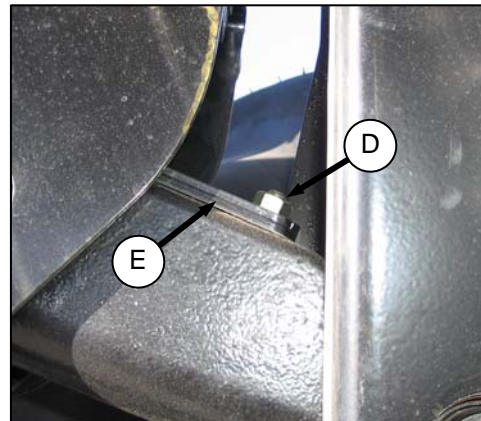

- On high side, remove nut, washer and bolt (D) that attaches shims (E) to link.
- Remove one or both shims (E) and reinstall the hardware (D).



CAUTION

Check to be sure all bystanders have cleared the area.

- Start engine and raise header slightly. Check level of header.

(continued next page)

HEADER OPERATION

- f. If additional levelling is required, install the removed shim on the opposite linkage.

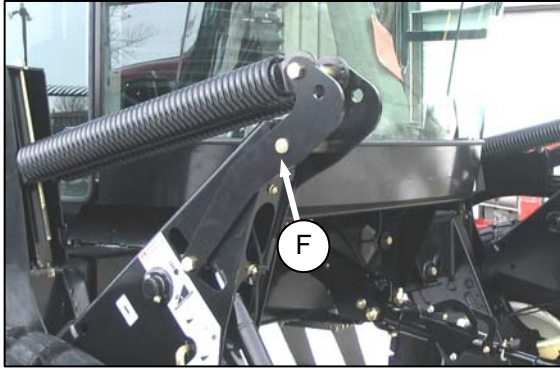

- g. Once header is level, return float pins to their engaged position (F).

NOTE

If required, additional shims are available from your dealer

NOTE

Float does not require adjustment after levelling header.

6.4.3 Header Drive

The headers are hydraulically driven and controlled from the windrower with no mechanical drive shafts. One hydraulic piston pump on the windrower provide fluid power to the knife, and three gear pumps power the drapers or auger, reel, lift and positioning systems and optional attachments.



CAUTION

Check to be sure all bystanders have cleared the area.

Engage the header as follows:

- a. Move throttle to adjust engine speed to idle.



- b. Engage header by pushing down on the yellow knob and pulling up on the black ring at the base of the switch.
- c. A slight delay between switch on and operating speed is normal.
- d. Push yellow knob to disengage header drive.

HEADER OPERATION

6.4.4 Header Angle

Header angle is defined as the angle between the ground and the drapers/cutterbar and is adjustable to accommodate crop conditions and/or soil type.

Refer to the appropriate operator's manual for range of adjustment and recommended settings for your particular header.

IMPORTANT

Changing header angle will affect flotation slightly because it has the effect of making the header lighter or heavier.

IMPORTANT

To prevent excessive guard breakage when cutting on the ground and when conditions are not suited to heavier float (e.g. rocky or wet), do not use the tilt control on the go. Instead, use the header height switch.

Change header angle as follows:

HYDRAULIC CENTER LINK (Optional)

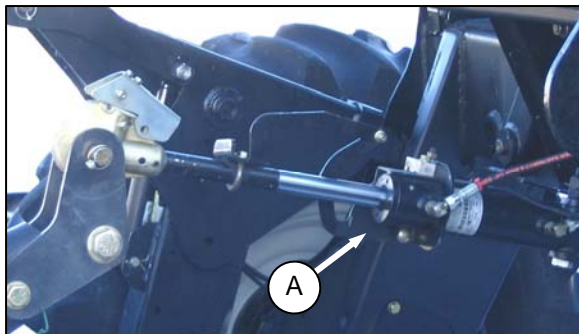
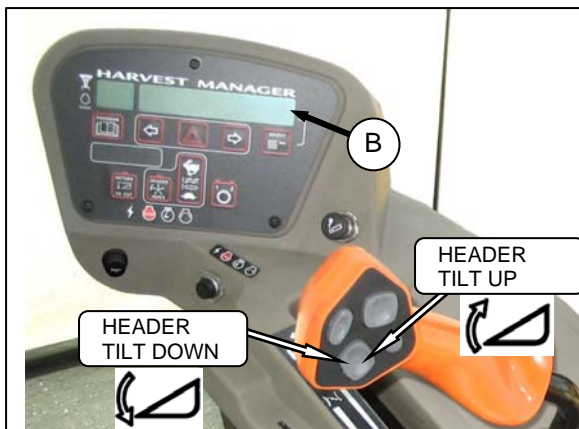

- To decrease (flatten) header angle, operate HEADER TILT UP switch on GSL handle so that cylinder (A) retracts. The CDM display will show a reading on the lower line (B) of decreasing value between 00.0 and 10.0.

- To increase (steepen) header angle, operate HEADER TILT DOWN switch on GSL handle so that cylinder (A) extends. The CDM display will show a reading on the lower line of increasing value between 00.0 and 10.0.
- The header tilt switch can be deactivated to prevent inadvertent header angle changes when pressing the header height control switches.
 - To deactivate, press and hold PROGRAM switch and momentarily press either HEADER TILT UP or HEADER TILT DOWN.

NOTE

If either of the header tilt switches are pressed while deactivated, the lower display line will indicate "TILT DISABLED" for five seconds along with a tone.

- To reactivate, repeat above procedure.

MECHANICAL CENTER LINK

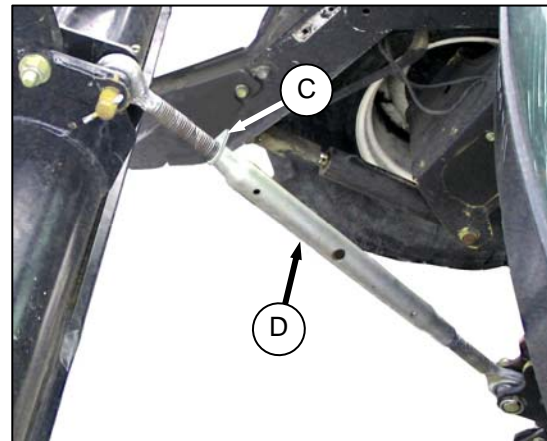

- Loosen plate nut (C).
- To increase (steepen) angle, rotate barrel (D) to lengthen center link.
- To decrease (flatten) angle, rotate barrel (D) to shorten center link.
- Tighten plate nut (C) with a slight tap of a hammer.

HEADER OPERATION

6.4.5 Cutting Height

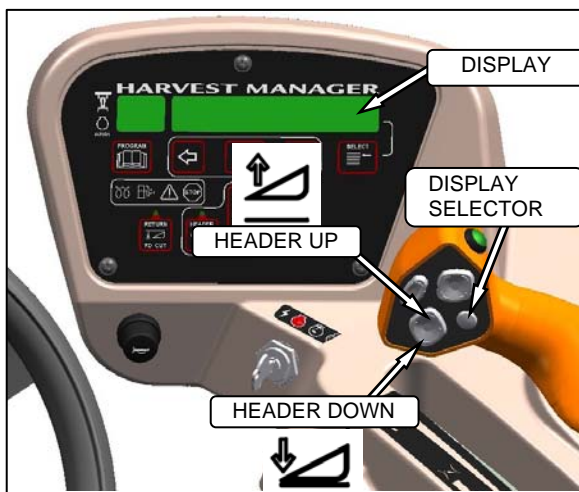

The header is raised or lowered with the HEADER UP or HEADER DOWN switches on the GSL. See illustration. The CDM indicates the header height by a reading on the DISPLAY lower line between **00.0** and **10.0**, with 00.0 being on the ground. Use DISPLAY SELECTOR switch to display the current setting.

6.4.5.1 Return To Cut (Optional)

The monitoring system assists the operator in maintaining the desired cutting height with the RETURN TO CUT feature that can be turned off or on with a switch on the CDM.

The RETURN TO CUT feature enables the operator to have the header return to a pre-selected cutting height and angle. If desired, the CDM can be programmed so that only the cutting height feature is active. The unit is pre-programmed to activate both cutting height and header angle.

- a. Program the RETURN TO CUT feature as follows:

IMPORTANT

The windrower must be running with the header engaged.

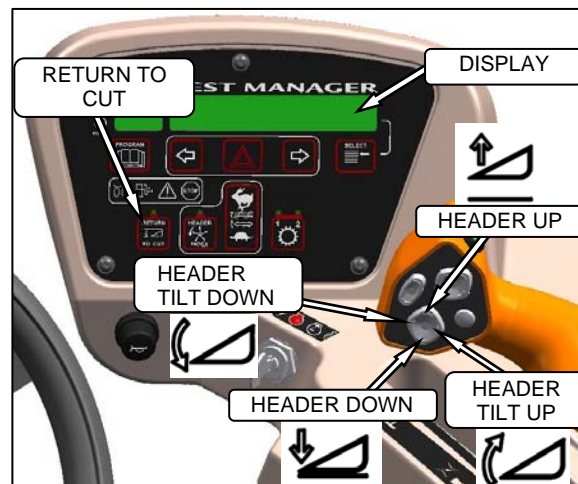

1. RETURN TO CUT switch must be off (indicator light is off).
2. Adjust the header to the desired height with the HEADER UP or HEADER DOWN switches on the GSL. CDM displays between **00.0** and **10.0**.
3. Adjust the header angle with the HEADER TILT UP or HEADER TILT DOWN switches on the GSL. CDM displays between **.0** and **10.0**. This step is not required if height only has been pre-selected.
4. Press the RETURN TO CUT switch on the CDM. The indicator light will illuminate and the settings are now programmed into the WCM.

- b. Use the RETURN TO CUT feature as follows:

IMPORTANT

Ensure the header is engaged and the RETURN TO CUT switch is illuminated.

NOTE

*The header can be raised or lowered at any time by **depressing and holding** the HEADER UP or HEADER DOWN switches on the GSL.*

1. If header is above the pre-set height, **momentarily press** HEADER DOWN switch and header will return to pre-set height.

(continued next page)

HEADER OPERATION

- If the header is below the pre-set height, **press and hold** the HEADER UP switch to raise the header. Release switch to stop header. Alarm will sound when header rises past the pre-set height.
- If the header angle is changed, double click (two clicks within 0.5 seconds) the HEADER TILT UP or HEADER TILT DOWN switch and the header will return to the pre-set angle.

NOTE

If the header cannot return to the pre-set height or angle within 30 seconds, the RETURN TO CUT feature will deactivate to prevent the hydraulic oil from overheating. Push the RETURN TO CUT switch to reactivate.

6.4.5.2 Auto-Raise Height

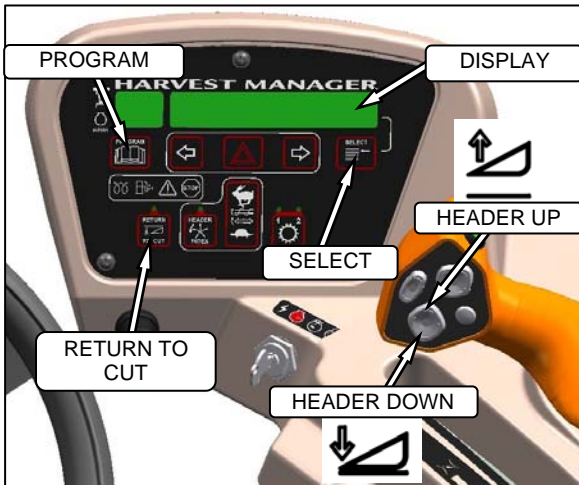

- Program the AUTO RAISE HEIGHT feature as follows:
 - RETURN TO CUT switch can be off or on.
 - PROGRAM and SELECT on CDM to enter programming mode.
 - Press SELECT. TRACTOR SETUP? is displayed on upper line.
 - Press \rightarrow , then SELECT. SET KNIFE SPEED? is displayed.
 - Press SELECT until AUTO RAISE HEIGHT is displayed.
 - Press \leftarrow or \rightarrow to change value on lower line. Range is 0.0 to 10.0 where 10.0 is fully raised.
 - Press PROGRAM to exit programming mode when finished entering desired values.

- Use the AUTO RAISE HEIGHT feature as follows:

IMPORTANT

The windrower must be running with the header engaged at the cutting height and the RETURN TO CUT switch activated.

- Double click HEADER UP switch on the GSL to raise the header to the AUTO RAISE HEIGHT set point.

NOTE

If HEADER UP is pressed while header is being raised, AUTO RAISE HEIGHT is temporarily disabled and header will maintain current height.

- Momentarily press the HEADER DOWN switch on the GSL to return the header to the pre-set cutting height.

HEADER OPERATION – D SERIES

6.5 D SERIES HEADER OPERATION



6.5.1 Header Attachments

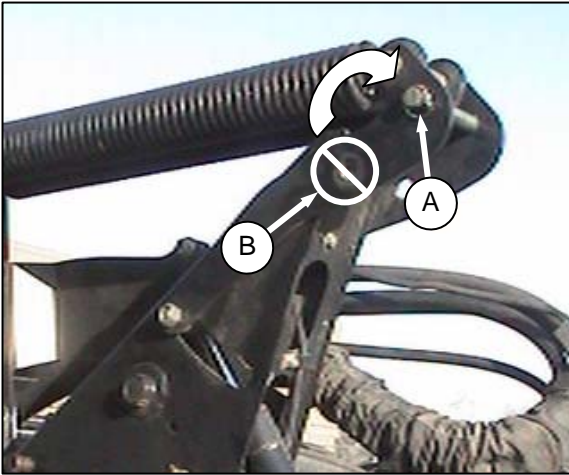

IMPORTANT

To prevent damage to the lift system when lowering header lift linkages without a header or weight box attached to windrower, ensure that float engagement pin is installed in storage location (A), and **not** installed at hole location (B).

- a. If not installed, attach draper header boots (supplied with header) to windrower lift linkage as follows:

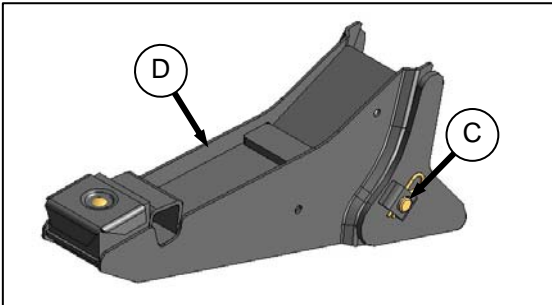

1. Remove hairpin and remove pin (C) from boot (D).

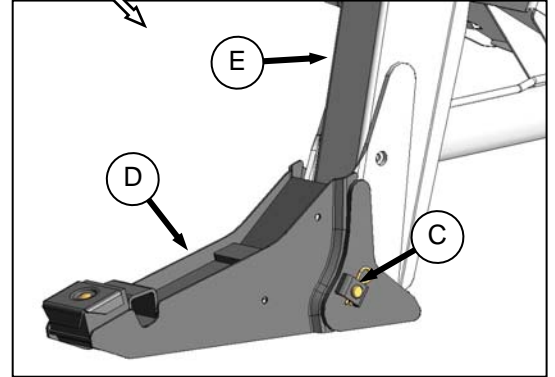

2. Locate boot (D) on lift linkage (E) and reinstall pin (C). Pin may be installed from either side of boot.
3. Secure pin (A) with hairpin.
4. Repeat for opposite side.

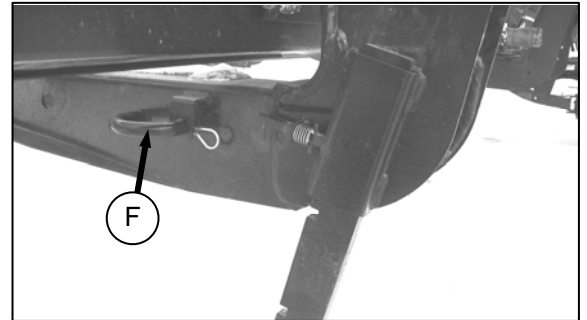

- b. Remove hairpin on pins (F) and remove pins from header legs.



CAUTION

Check to be sure all bystanders have cleared the area.

(continued next page)

HEADER OPERATION – D SERIES

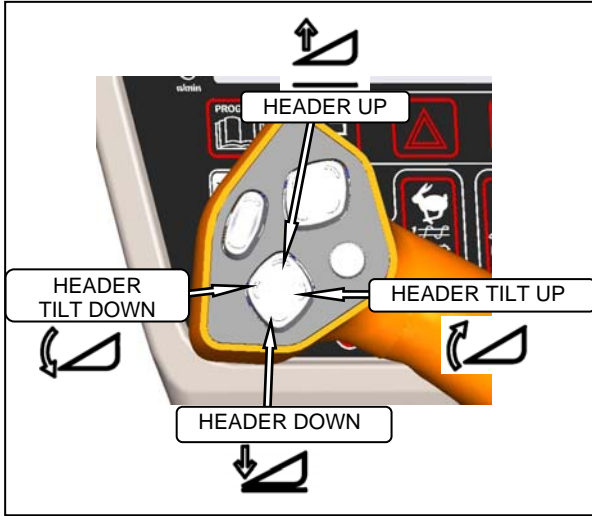

- c. 99Start the engine and activate header down button on the GSL to fully retract header lift cylinders.

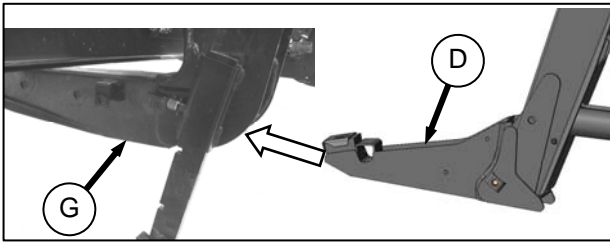

- d. Slowly drive windrower forward so that boots (D) enter header legs (G). Continue to drive slowly forward until lift linkages contact support plates in the header legs, and header nudges forward.
- e. Check that linkages are properly engaged in header legs, contacting support plates.

Connect center link as follows:

MECHANICAL LINK – M150

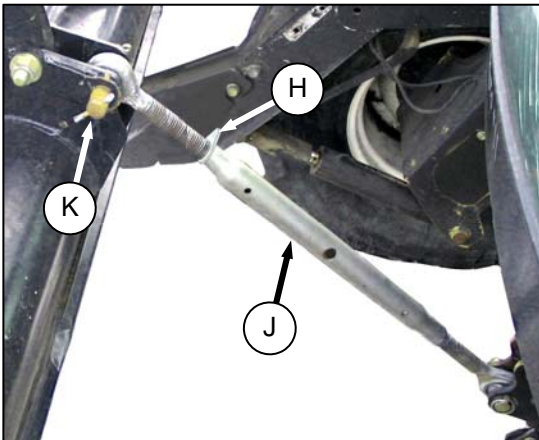

1. Loosen nut (H) and rotate barrel (J) to adjust length so that link lines up with header bracket.

2. Install pin (K) and secure with cotter pin.
3. Adjust link to required length for proper header angle by rotating barrel (J). Tighten nut (H) against barrel. A slight tap with a hammer is sufficient.
4. Proceed to step g.

HYDRAULIC LINK - OPTION

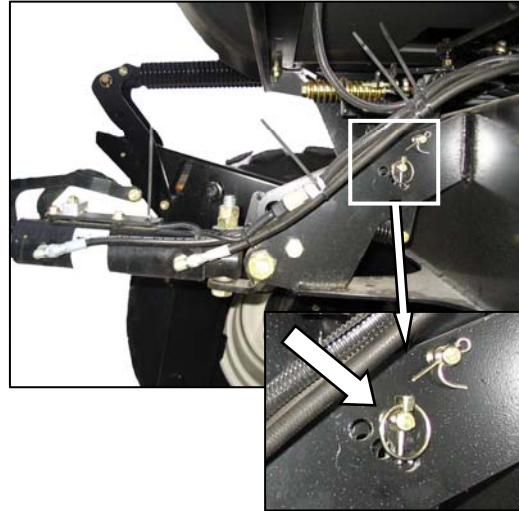

1. Re-locate the pin at the frame linkage as required to position the hook over the header pin.

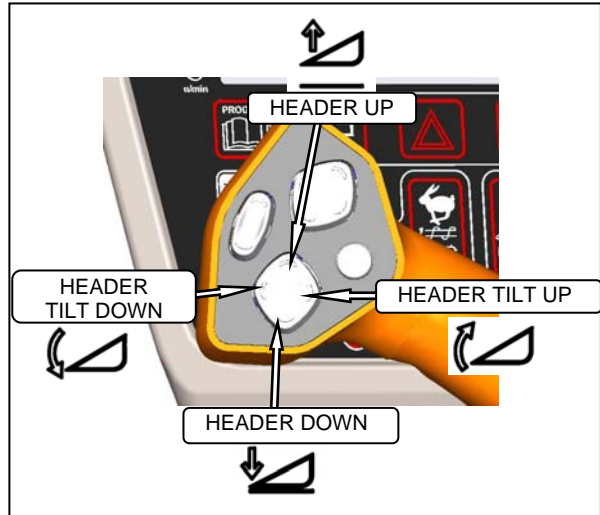

2. Activate header tilt cylinder switches on GSL to extend or retract center link cylinder so that the hook lines up with the header attachment pin.

(continued next page)

HEADER OPERATION – D SERIES



3. Push down on rod end of link cylinder (K) until hook engages pin on header and is locked.
 4. Check that center link is locked onto header by pulling upward on rod end of cylinder.
- g. Raise the header fully with the header up switch on the GSL. Stop engine and remove key.



DANGER

To avoid bodily injury from fall of raised header, always engage header lift cylinder stops when working on or around raised header.

- h. Engage lift cylinder stops on both lift cylinders. Refer to Section 6.4.1 Header Lift Cylinder Stops.

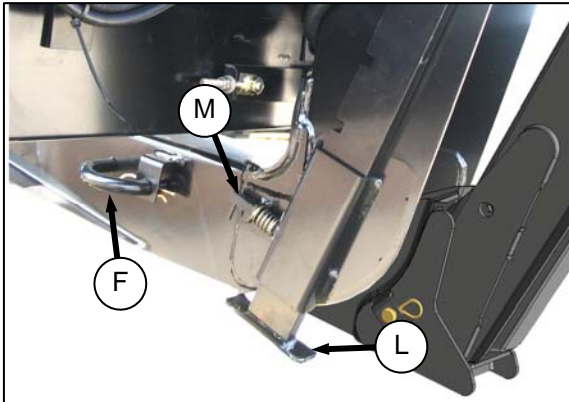

- i. Install pin (F) through header leg, (engaging U-bracket in lift linkage) on both sides and secure with hairpin.

NOTE

Install hairpin with open end facing aft.

- j. Raise header stand (L) to storage position by pulling pin (M) and lifting stand into uppermost position. Release pin (M).

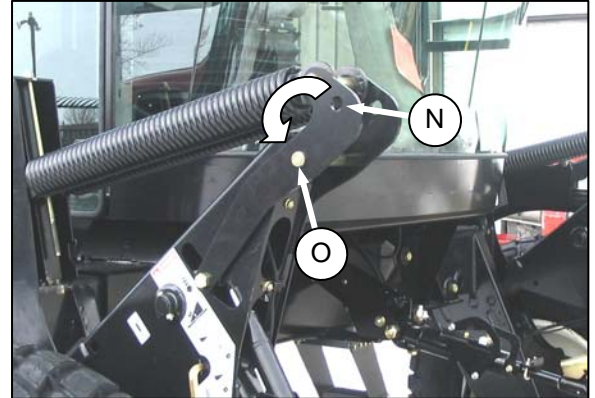

- k. Remove pin from storage position (N) in linkage and insert in hole (O) to engage float springs. Secure with hairpin.
- l. Disengage lift cylinder stops. Refer to Section 6.4.1 Header Lift Cylinder Stops.
- m. Start engine and activate header lift cylinders (switch on GSL) to lower header fully.
- n. Stop engine and remove key.



HEADER DRIVE HOSES

- o. Connect header drive hoses (P) and electrical harness (Q) to header. Refer to the Draper Header Operator's Manual.

(continued next page)

HEADER OPERATION – D SERIES

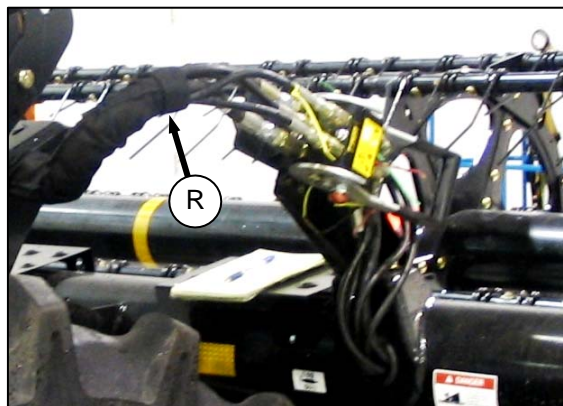

REEL HYDRAULICS

- p. Connect reel hydraulics (R) at RH side of windrower. Refer to the Draper Header Operator's Manual.

6.5.2 Header Detachment

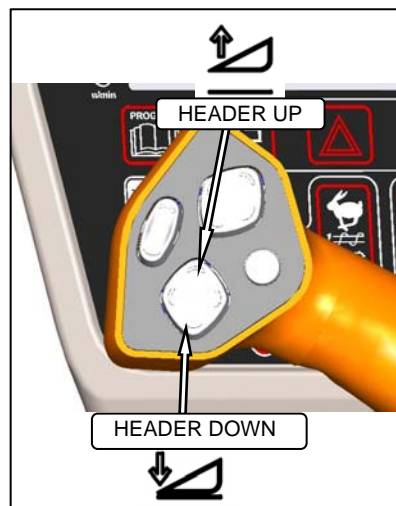

- a. Raise the header fully with the header up switch on the GSL. Stop engine and remove key.



DANGER

To avoid bodily injury from fall of raised header, always engage header lift cylinder stops when working on or around raised header.

- b. Engage lift cylinder stops on both lift cylinders. Refer to Section 6.4.1 Header Lift Cylinder Stops.

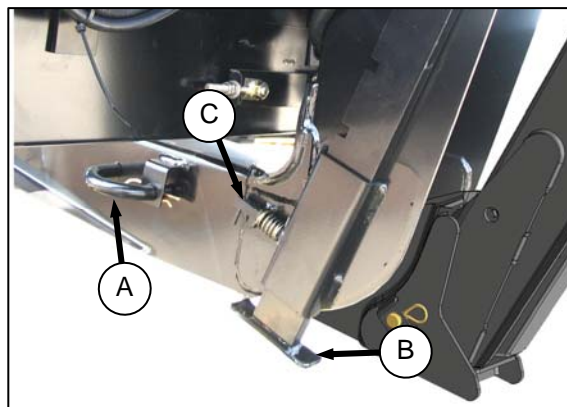

- c. Remove pin (A) from header leg on both sides.
d. Lower header stand (B) by pulling spring loaded pin (C). Release pin to lock stand.

(continued next page)

HEADER OPERATION – D SERIES

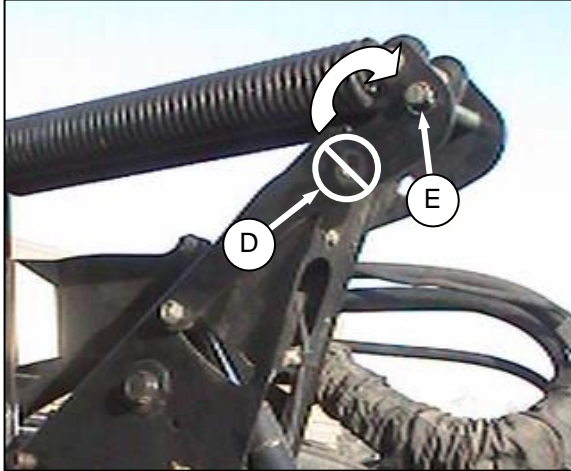

- e. Remove pin from location (D) to disengage float springs, and insert in storage hole (E). Secure with lynch pin.

IMPORTANT

To prevent damage to the lift system when lowering header lift linkages without a header or weight box attached to windrower, ensure that float engagement pin is installed in storage location (E), and **not** installed at hole location (D).

- f. Disengage lift cylinder stops.
g. Start engine, choose a level area and lower header to the ground. Stop engine and remove key.

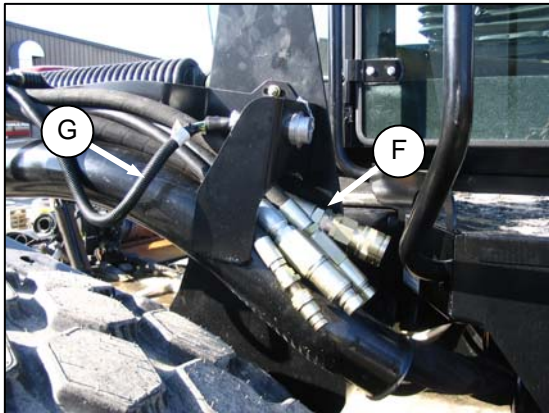

HEADER DRIVE HOSES

- h. Disconnect header drive hydraulics (F) and electrical harness (G) from header. Refer to the Draper Header Operator's Manual.

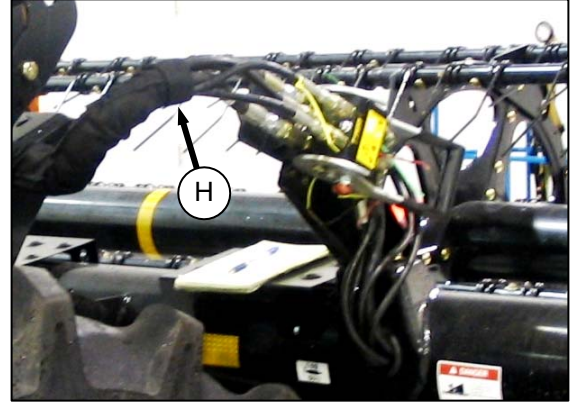

REEL HYDRAULICS

- i. Disconnect reel hydraulics (H) and store on bracket at windrower LH side.
j. Disconnect center link as follows:

MECHANICAL LINK – M150

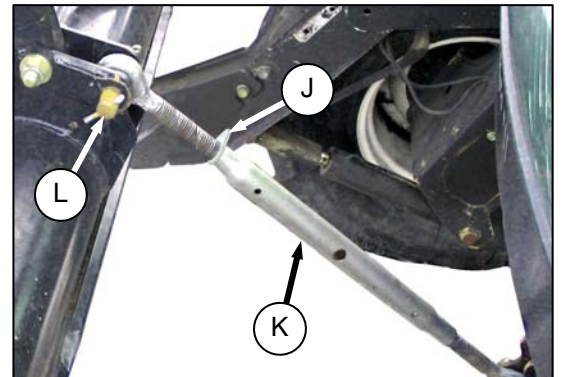

1. Loosen nut (J) and rotate barrel (K) to relieve load on link.
2. Remove cotter pin on pin (L), and remove pin to disconnect from windrower. Re-install pin in header.
3. Tighten nut (J) against barrel. A slight tap with a hammer is sufficient.

(continued next page)

HEADER OPERATION – D SERIES

HYDRAULIC LINK – OPTION

1. Start engine and activate header tilt cylinder switch on GSL to release load on center link cylinder.

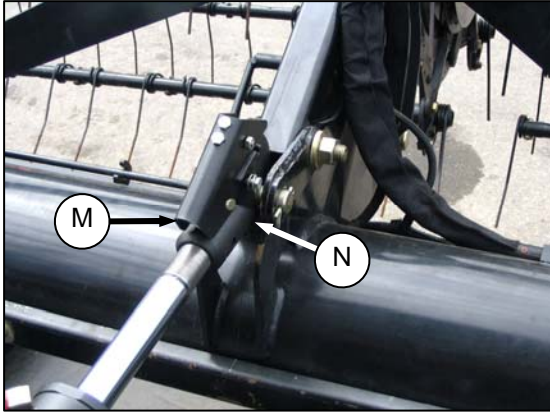

2. Disconnect center link by lifting release (M) and lift hook (N) off header.
- k. Slowly back windrower away from header.

NOTE

If hay conditioner is installed, watch clearances on both sides.

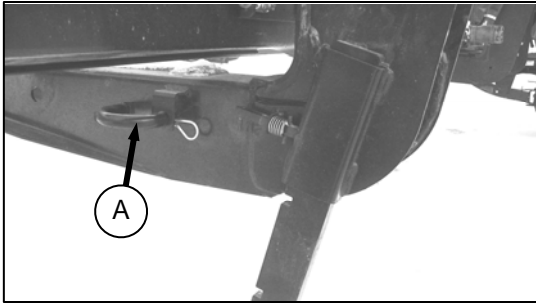

- l. Reinstall pin (A) into header leg and secure with hairpin.

6.5.3 Header Position Adjustments

Refer to Section 6.4 HEADER OPERATION for procedures for controlling header height, header tilt, and float.

6.5.4 Reel Fore-Aft Position (Optional)



Press and hold the switch for the desired fore or aft movement of the reel.

6.5.5 Reel Height

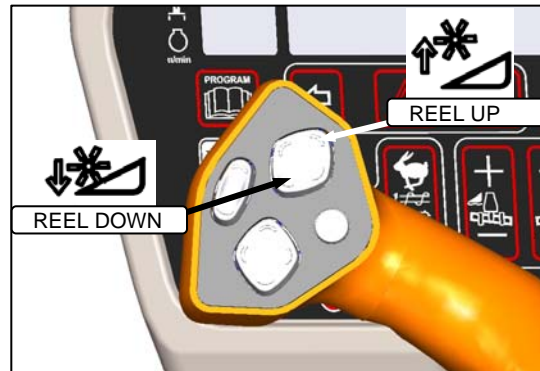

Press and hold the switch for the desired up or down movement of the reel.

HEADER OPERATION – D SERIES

6.5.6 Reel Speed

Reel speed is controlled with switches on the CDM in the cab. On D Series draper headers, it can be set relative to the ground speed of the windrower using the Header Index feature, or can run independently. Refer to the Operator's Manual for your specific header for windrowing guidelines and recommended speeds.

6.5.6.1 Reel to Ground Speed – Index (Option)

Setting the speed of the reel relative to ground speed using the Header Index function allows the operator to maintain a preset reel to ground speed, while operating at varying ground speeds. This feature requires that an "expansion module" has been installed, either at the factory or at your dealer. To use this feature, set the Minimum Reel Speed, and set the Reel Index as follows:

- a. Set **Reel Minimum Speed**

IMPORTANT

Windrower can be moving but must be less than minimum reel speed.



CAUTION

Check to be sure all bystanders have cleared the area.

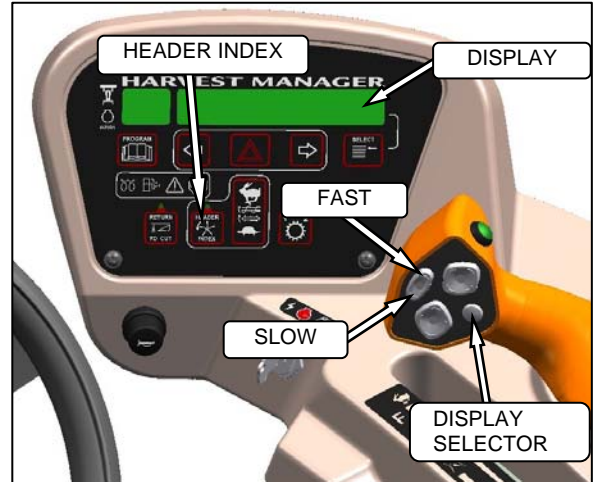
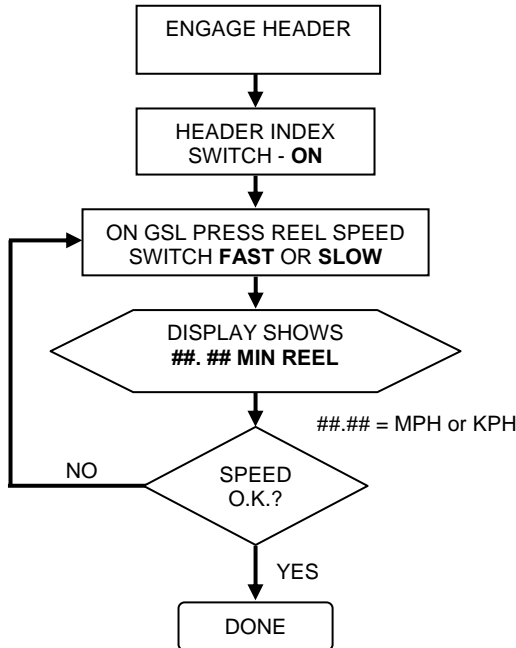

NOTE

DISPLAY will flash ###.## MIN REEL (MPH or KPH) to prompt the operator to change the minimum set point or increase ground speed if Ground Speed Plus Index is less than the Minimum Reel Speed Set Point.

- b. Set **Reel Index** while driving windrower at **normal operating speed** and greater than minimum reel speed.

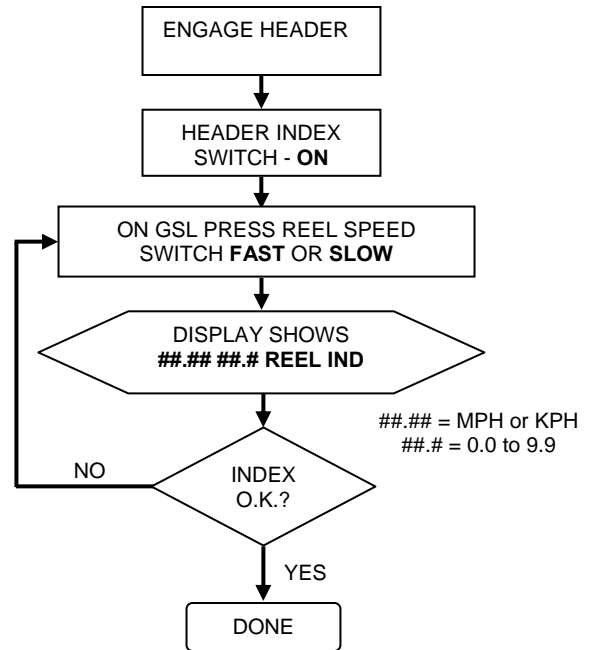

NOTE

See example on following page.

(continued next page)

HEADER OPERATION – D SERIES

Example:

Windrower is operating at 8 mph with Header Index on and set at 5.5. Display shows;

13.5 5.5 REEL IND

where **13.5** (8+5.5) is the reel speed in mph, and **5.5** is the header index setting.

Windrower speed drops to 7.5 mph at same Header Index setting. Display shows;

13.0 5.5 REEL IND

where **13.0** (7.5+5.5) is the reel speed in mph, and **5.5** is the header index setting.

Windrower is operating at 8 mph with Header Index on and set at 1.0. Display shows;

9.0 1.0 REEL IND

where **9.0** (8+1.0) is the reel speed in mph, and **1.0** is the header index setting.

6.5.6.2 Reel Only Speed

Set the reel speed independently of ground speed as follows:



CAUTION

Check to be sure all bystanders have cleared the area.

NOTE

This procedure can also be used to change the draper speed "on the go". These changes become the new set-points.

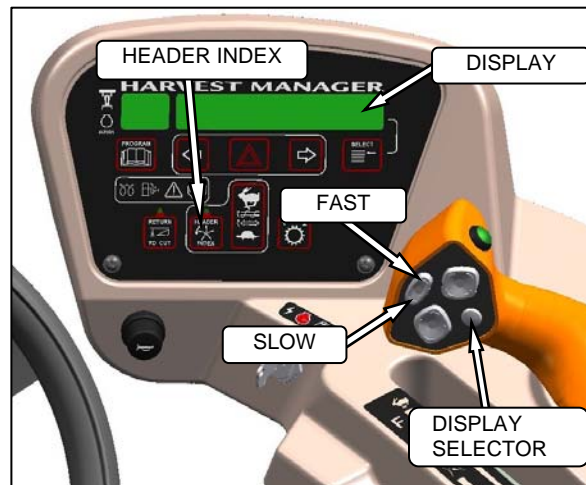
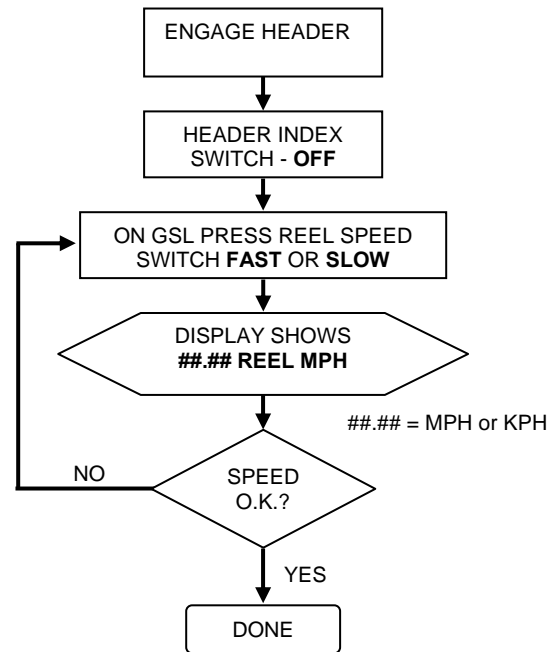

HEADER OPERATION – D SERIES

6.5.7 Draper Speed

Draper speed affects the orientation of stalks in the windrow. Faster draper speeds tend to form herringbone or dovetail configurations. Refer to your header operator's manual for guidelines on what speed to use.

The draper speed can be set with switches on the CDM relative to the ground speed of the windrower with the Header Index function, or can run independently. This feature requires that an "expansion module" has been installed, either at the factory or at your dealer.



CAUTION

Check to be sure all bystanders have cleared the area.

6.5.7.1 Draper To Ground Speed – Index (Optional)

To use this feature, set the Draper Minimum Speed, and set the Draper Index.

NOTE

Reducing engine speed saves fuel and reduces noise in the cab. Ground/cutting speed can be maintained using this feature.

a. Set Draper Minimum Speed:

IMPORTANT

Windrower can be moving but must be less than minimum reel speed.

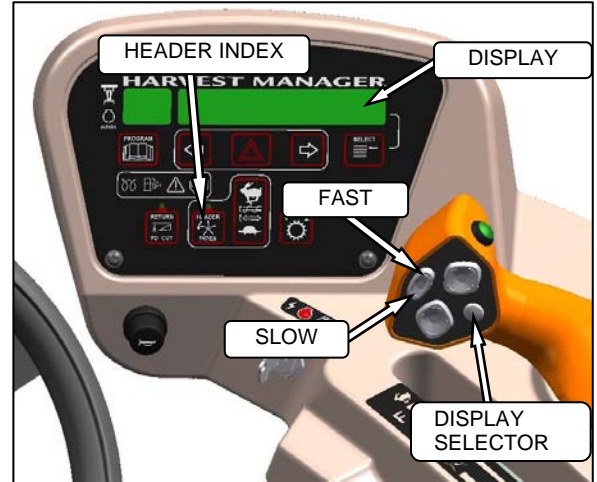
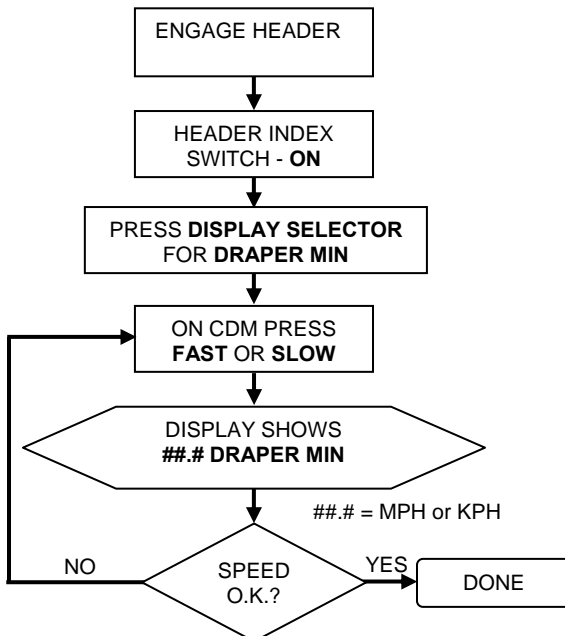

NOTE

DISPLAY will flash ##.# MIN CONV (MPH or KPH) to prompt the operator to change the minimum set point or increase ground speed if Ground Speed Plus Index is less than the Minimum Draper Speed Set Point.

b. Set Draper Index while driving windrower at normal operating speed and greater than minimum draper speed.

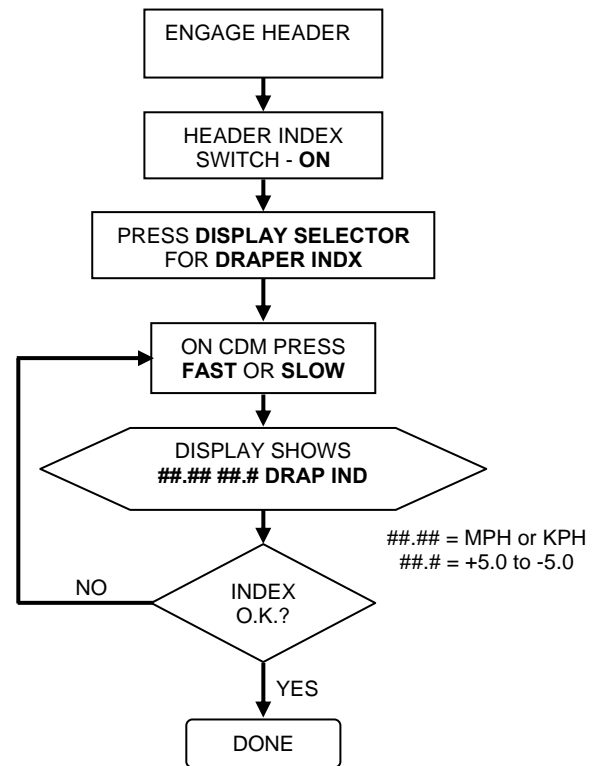

NOTE

See example on following page.

(continued next page)

HEADER OPERATION – D SERIES

Example:

Windrower is operating at 8 mph with Header Index on and set at 1.5. Display shows;

9.5 1.5 DRAP INDX

where **9.5** (8+1.5) is the draper speed in mph, and **1.5** is the header index setting.

Windrower speed drops to 7.5 mph at same Header Index setting. Display shows;

9.0 1.5 DRAP INDX

where **9.0** (7.5+1.5) is the draper speed in mph, and **1.5** is the header index setting.

Windrower is operating at 8 mph with Header Index on and set at 0.9. Display shows;

8.9 0.9 DRAP INDX

where **8.9** (8+0.9) is the draper speed in mph, and **0.9** is the header index setting.

6.5.7.2 Draper Speed Independent of Ground Speed

Set the speed of the draper independently of ground speed as follows:

NOTE

This procedure can also be used to change the draper speed “on the go”.



CAUTION

Check to be sure all bystanders have cleared the area.

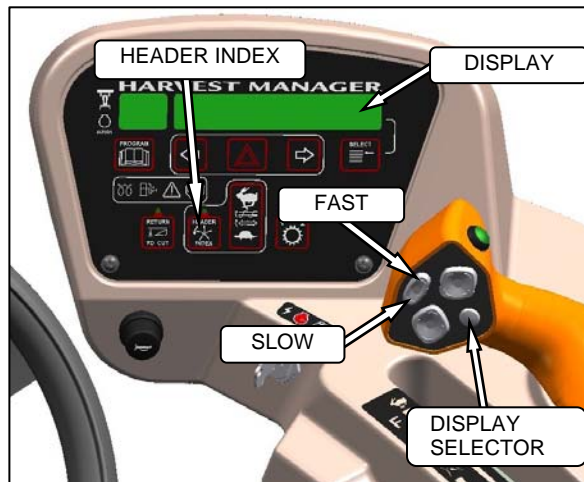
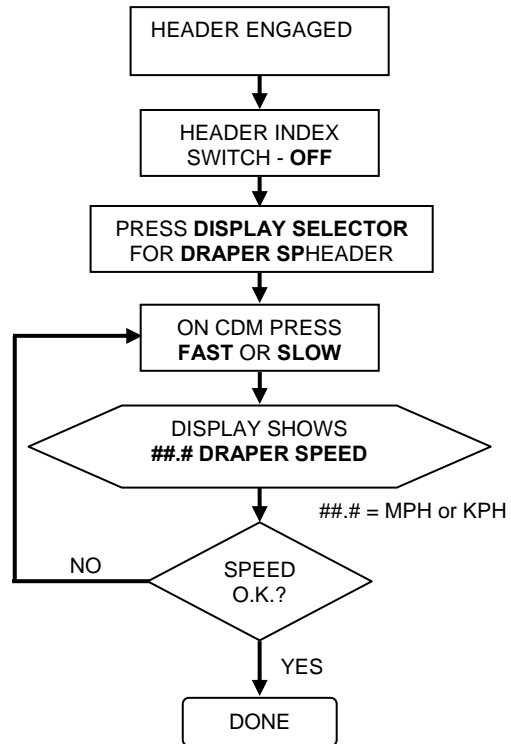

HEADER OPERATION – D SERIES

6.5.8 Knife Speed

The ideal cutting speed of the knife should be such that a clean cut is achieved. Crop types and conditions usually influence the knife and forward speeds. Refer to the header operator's manual for more information on knife speeds.

The knife speed is manually set by making adjustments to the knife drive pump and has been pre-set at the factory. For optimum performance, adjust the knife speed according to the header being used. See the following table.

If the machine is equipped with the appropriate sensor and optional module, the CDM will notify the operator when the knife speed reaches an overload pre-set (usually 75% of knife speed). The pre-set can be changed on the CDM. Refer to Section 5.18.5 CDM Programming.

NOTE

The knife speed should stay within the range specified for each header.

HEADER DESCRIPTION		KNIFE SPEED			
TYPE	SIZE	MINIMUM		MAXIMUM	
		RPM	SPM	RPM	SPM
Draper DK	15	750	1500	950	1900
Draper DK	20 & 25	700	1400	850	1700
Draper DK	30	600	1200	800	1600
Draper DK	35			700	1400
Draper SK	20 & 25			750	1500
Draper SK	30	700	1400	700	1400
Draper SK	35				

RPM = speed of wobble box pulley.
SPM = strokes per minute of knife (RPM x 2).

- a. Determine the knife speed as follows if the machine is not equipped with the optional module:



CAUTION

Check to be sure all bystanders have cleared the area.

1. Run engine at 2600 rpm with the header drive engaged and with ISC off.



2. Check wobble box pulley speed with a hand-held tachometer.
 3. Multiply the rpm reading by two for the knife speed in strokes per minute.
- b. Determine the knife speed as follows if the machine is equipped with the optional module:
1. Run engine at 2600 rpm with the header drive engaged and ISC off.



2. Press SELECTOR button on the GSL until the CDM displays the knife speed in SPM.
- c. If required, adjust knife speed as follows:



DANGER

Stop engine and remove key from ignition before leaving operator's seat for any reason. A child or even a pet could engage an idling machine.

1. Shutdown engine.

(continued next page)

HEADER OPERATION – D SERIES

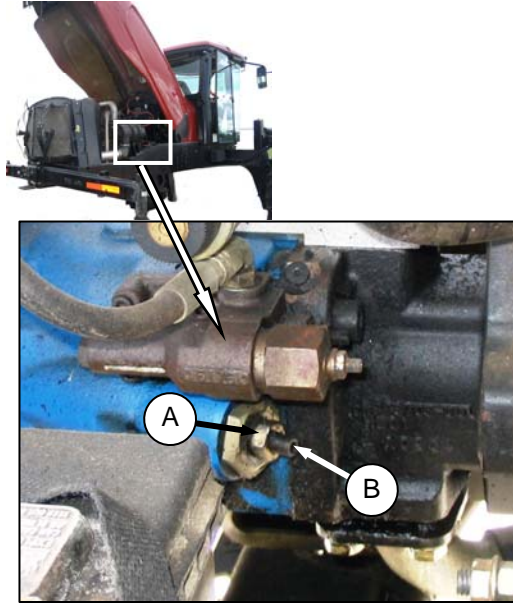

2. Loosen jam-nut (A).
3. Turn adjuster screw (B) clockwise (screw in) to decrease knife speed, and counter-clockwise (screw out) to increase the knife speed.

NOTE

One turn of the adjuster screw will change the knife speed by approximately 116 strokes per minute, or the wobble box pulley speed by 58 revolutions per minute.

4. Once adjustment has been made re-torque jam nut (A) as shown.
- d. Start engine and recheck knife speed.

6.5.9 Deck Shift (Optional)

The hydraulic deck shift option allows the operator to control deck position and draper rotation from the operator's station. It enables crop delivery from left side, center, or right side of the header. Shift decks as follows:



CAUTION

Check to be sure all bystanders have cleared the area.



- a. Engage header by pushing down on the yellow knob and pulling up on the black ring at the base of the switch (A).
- b. Push rocker switch (B) to desired delivery position. Deck(s) will move, and direction of drapers will change accordingly.
- c. Operate windrower.

HEADER OPERATION – A SERIES

6.6 A SERIES HEADER OPERATION



6.6.1 Header Attachment – A Series

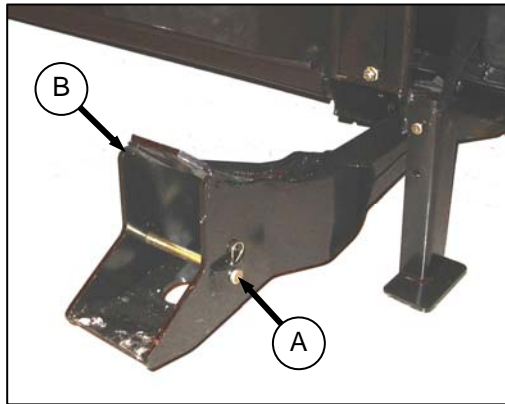

- a. Remove hairpin from pin (A), and remove pin from left and right header boots (B) on header.

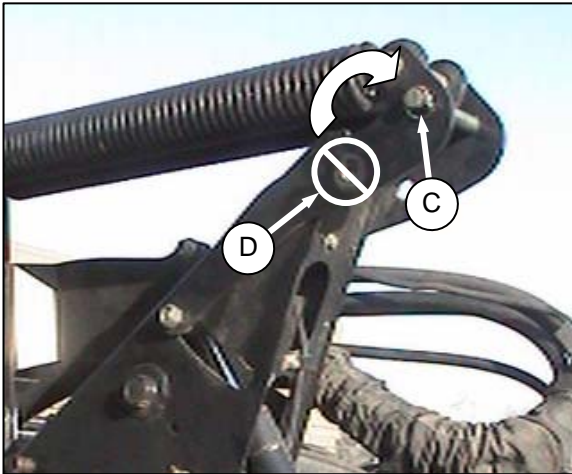

IMPORTANT

To prevent damage to the lift system when lowering header lift linkages without a header or weight box attached to windrower, ensure that float engagement pin is installed in storage location (C), and **not** installed at hole location (D).



CAUTION

Check to be sure all bystanders have cleared the area.

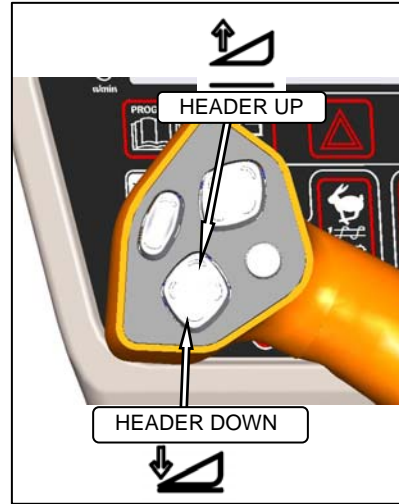

- b. Start the engine and activate HEADER DOWN button on the GSL to fully retract header lift cylinders.

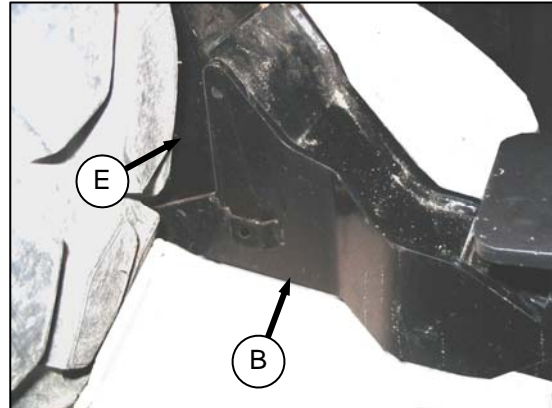

- c. Slowly drive windrower forward so that feet (E) on windrower enter boots (B) on the header. Continue to drive slowly forward until feet engage the boots, and header nudges forward.

(continued next page)

HEADER OPERATION – A SERIES

d. Connect center link as follows:

MECHANICAL LINK – M150

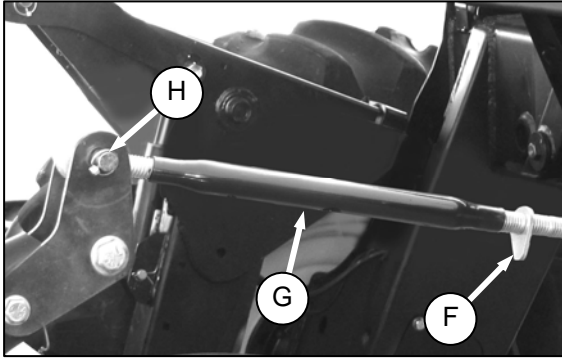

1. Loosen nut (F) and rotate barrel (G) to adjust length so that other end lines up with header bracket.
2. Install pin (H) and secure with cotter pins.
3. Adjust link to required length for proper header angle by rotating barrel (G). Tighten nut (F) against barrel. A slight tap with a hammer is sufficient.
4. Proceed to step e.

HYDRAULIC LINK - OPTION

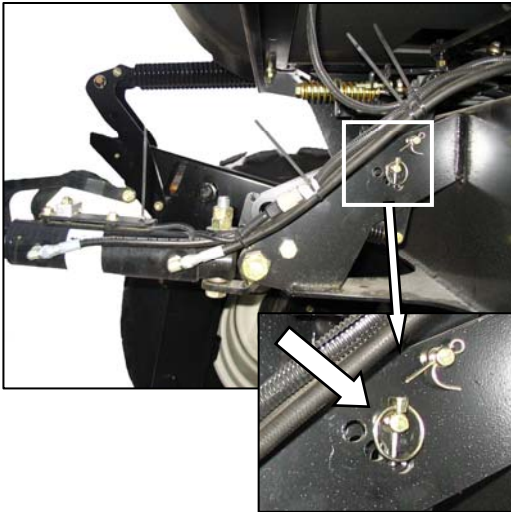

1. Re-locate the pin at the frame linkage as required to position the hook over the header pin.

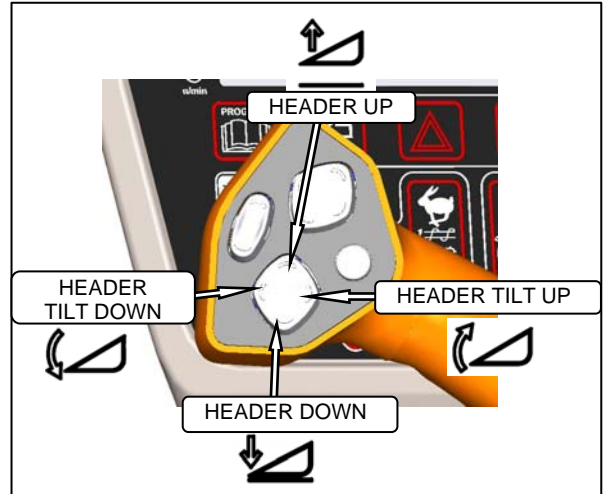

2. Activate HEADER TILT cylinder switches on GSL to extend or retract center link cylinder so that the hook lines up with the header attachment pin.

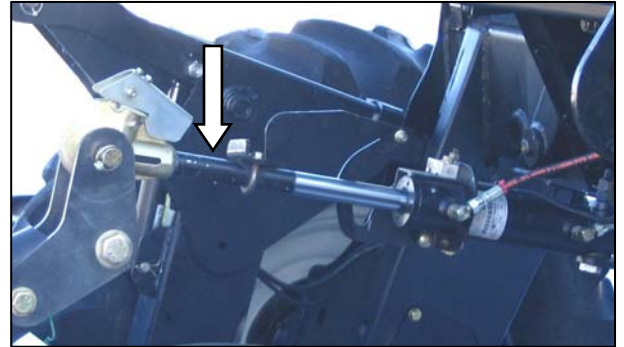

3. Push down on rod end of link cylinder until hook engages pin on header and is locked.
 4. Check that center link is locked onto header by pulling upward on rod end of cylinder.
- e. Raise the header fully with THE HEADER UP switch on the GSL. Stop engine and remove key.



DANGER

To avoid bodily injury from fall of raised header, always engage header lift cylinder stops when working on or around raised header.

- f. Engage lift cylinder stops on both lift cylinders. Refer to Section 6.4.1 Header Lift Cylinder Stops.

(continued next page)

HEADER OPERATION – A SERIES

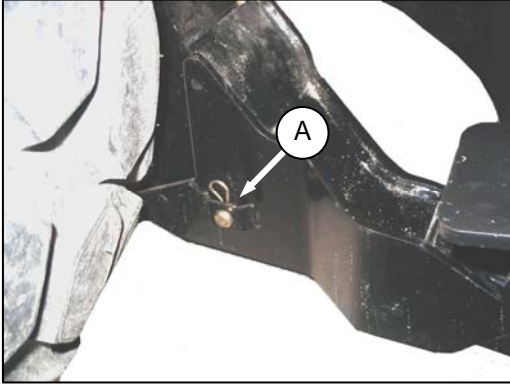

- g. Install pin (A) through each boot and foot and secure with hairpin..

IMPORTANT

Ensure pin (A) is fully inserted and hairpin is installed behind bracket.

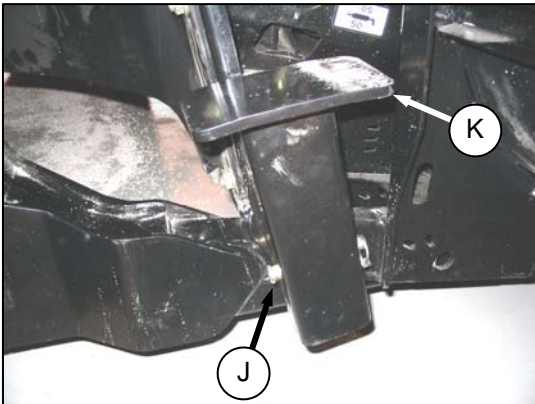

- h. Remove lynch pin from pin (J) in stand (K).
i. Hold stand and remove pin (J).
j. Reposition stand to storage position by inverting stand and re-locating on bracket as shown. Reinsert pin (J) and secure with lynch pin.

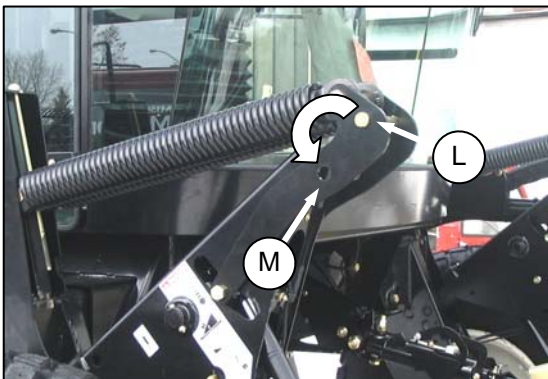

- k. Remove pin (L) from storage position in linkage and insert in hole (M) to engage float springs. Secure with lynch pin.

- l. Disengage lift cylinder stops.
m. Start engine, and activate header lift cylinder switch on GSL to lower header fully. Stop engine and remove key.

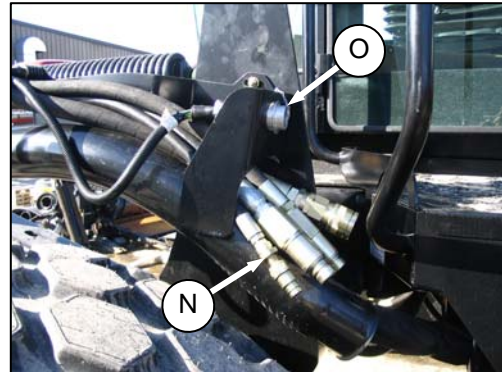

- n. Connect header drive hydraulics (N) and electrical harness (O) to header. Refer to Auger Header Operator's Manual.

HEADER OPERATION – A SERIES

6.6.2 Header Detachment

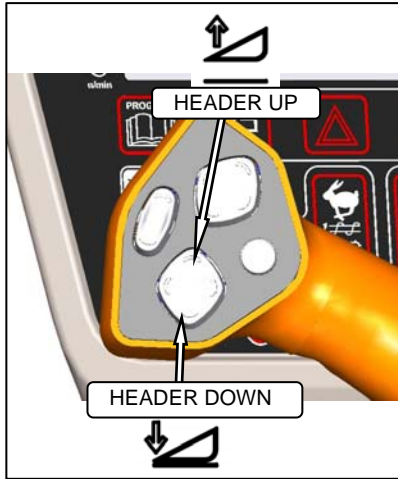

- a. Raise the header fully with the header up switch on the GSL. Stop engine and remove key.



DANGER

To avoid bodily injury from fall of raised header, always engage header lift cylinder stops when working on or around raised header.

- b. Engage lift cylinder stops on both lift cylinders. Refer to Section 6.4.1 Header Lift Cylinder Stops.

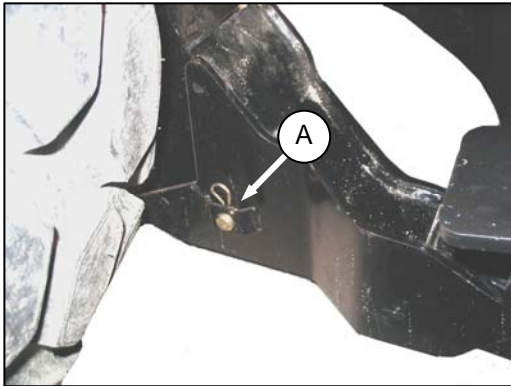

- c. Remove hairpin from pin (A), and remove pin from left and right header boots on header.

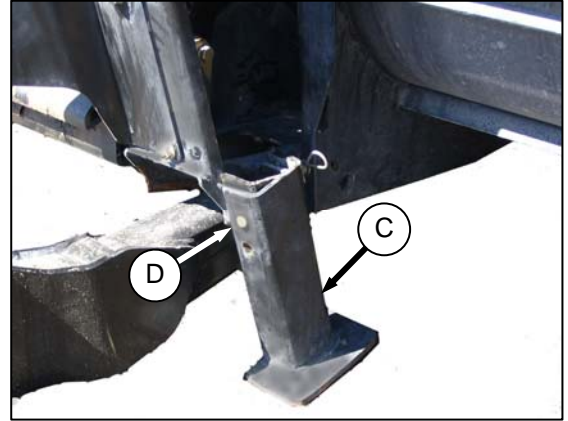

- d. Lower stand (C) by pulling pin (D), inverting stand and re-locating on bracket. Reinsert pin (D) and secure with hairpin.
- e. Remove pin from linkage (E) to disengage float springs, and insert in storage hole (F). Secure with lynch pin. Repeat for opposite linkage.

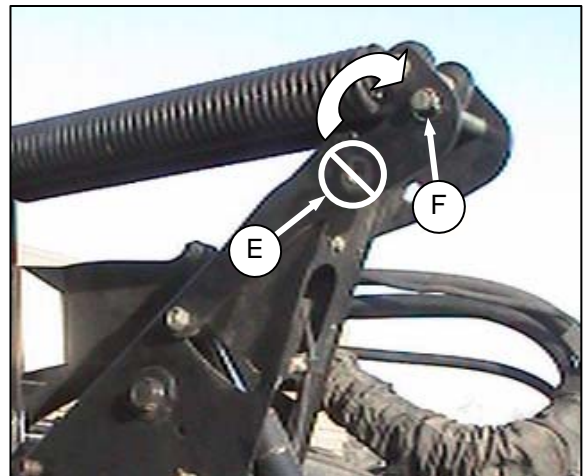

IMPORTANT

To prevent damage to the lift system when lowering header lift linkages without a header or weight box attached to windrower, ensure that float engagement pin is installed in storage location (F), and **not** installed at hole location (E).

- f. Disengage lift cylinder stops.
- g. Start engine, choose a level area and lower header to the ground.

(continued next page)

HEADER OPERATION – A SERIES

h. Disconnect center link as follows:

MECHANICAL LINK – M150

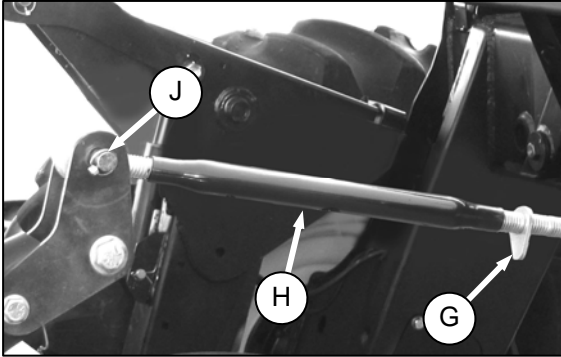

1. Loosen nut (G) and rotate barrel (H) to relieve load on link.
2. Remove cotter pin on pin (J), and remove pin to disconnect from header. Re-install pin in header.
3. Proceed to step i.

HYDRAULIC LINK – OPTION

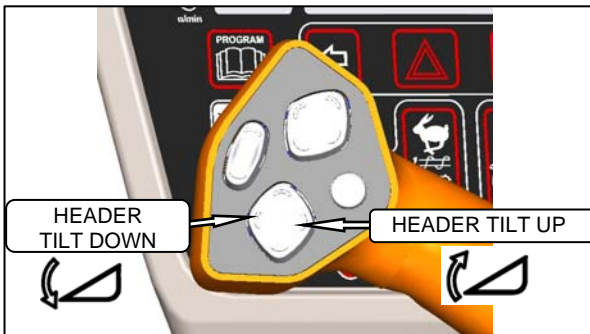

1. Activate header tilt cylinder switch on GSL to release load on center link cylinder (K).

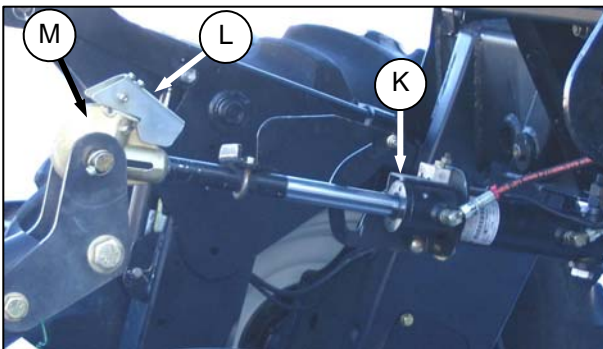

2. Lift hook release (L) and lift hook (M) off header pin.

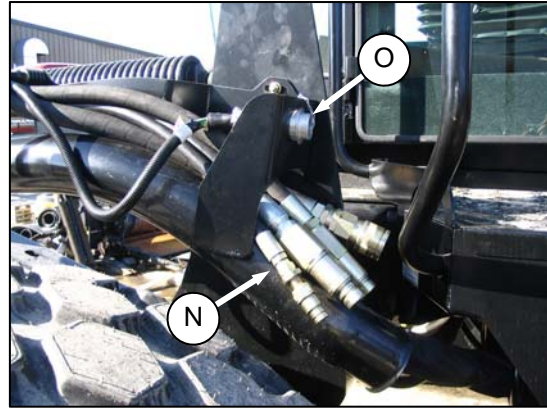

- i. Disconnect header drive hydraulics (N) and electrical harness (O). Refer to the Auger Header Operator's Manual.

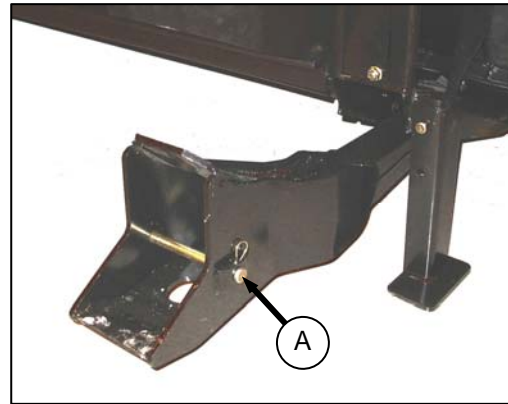

- j. Slowly back windrower away from header.
- k. Re-install pins (A) in header boots.

HEADER OPERATION – A SERIES

6.6.3 Auger Speed



CAUTION

Check to be sure all bystanders have cleared the area.

6.6.3.1 A40-D Headers

On A40-D double knife headers, the auger speed can be changed independently from the reel speed with a switch on the CDM. Change auger speed as follows:

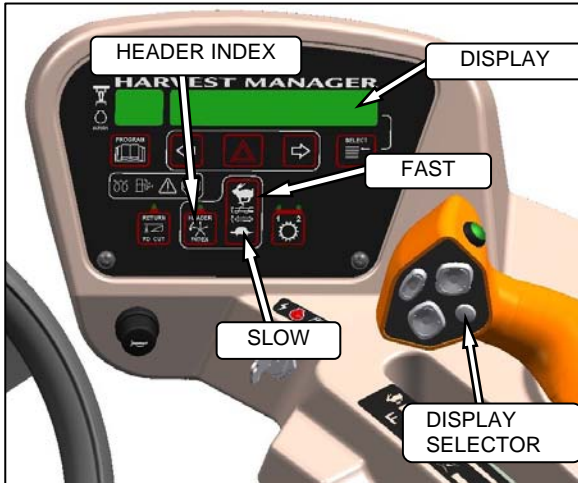

6.6.3.2 A30-S and A30-D Headers

On A30 Series auger headers, the auger speed is fixed to the knife speed.

NOTE

The auger speed can be independently changed from the knife speed by changing the drive sprocket. Refer to A30-S, A30-D & A40-D Self Propelled Windrower Headers OPERATOR'S MANUAL.

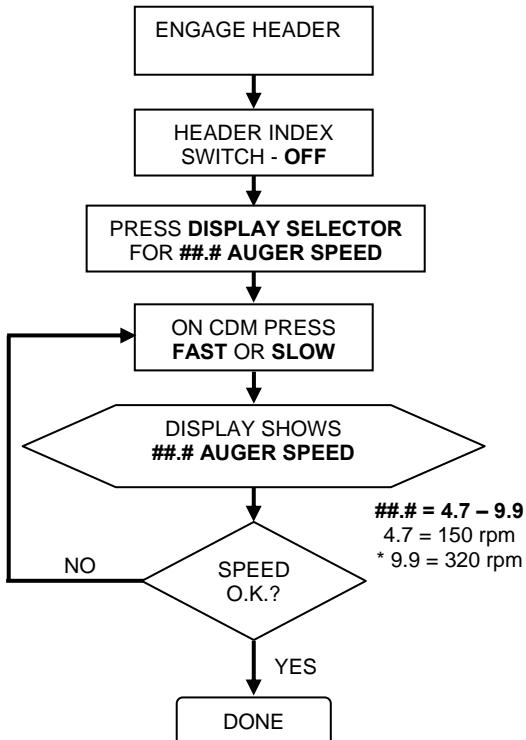

* Auger Speed Not To Exceed 320 rpm.

HEADER OPERATION – A SERIES

6.6.4 Reel Speed

6.6.4.1 A30-S and A30-D Headers

The reel speed is fixed to the auger speed and to the knife speed. Both can be changed by installing alternate drive sprockets. Refer to your Auger Header Operator's Manual.

6.6.4.2 A40-D Header

The A40-D auger header features a hydraulic direct drive reel with operating speed range of 51 to 76 rpm and is controlled with switches on the CDM, and on the GSL at the operator's station. The hydraulic flows for the reel and auger are interconnected so that the auger and reel speeds are controlled using a combination of the CDM switches and the GSL switches.

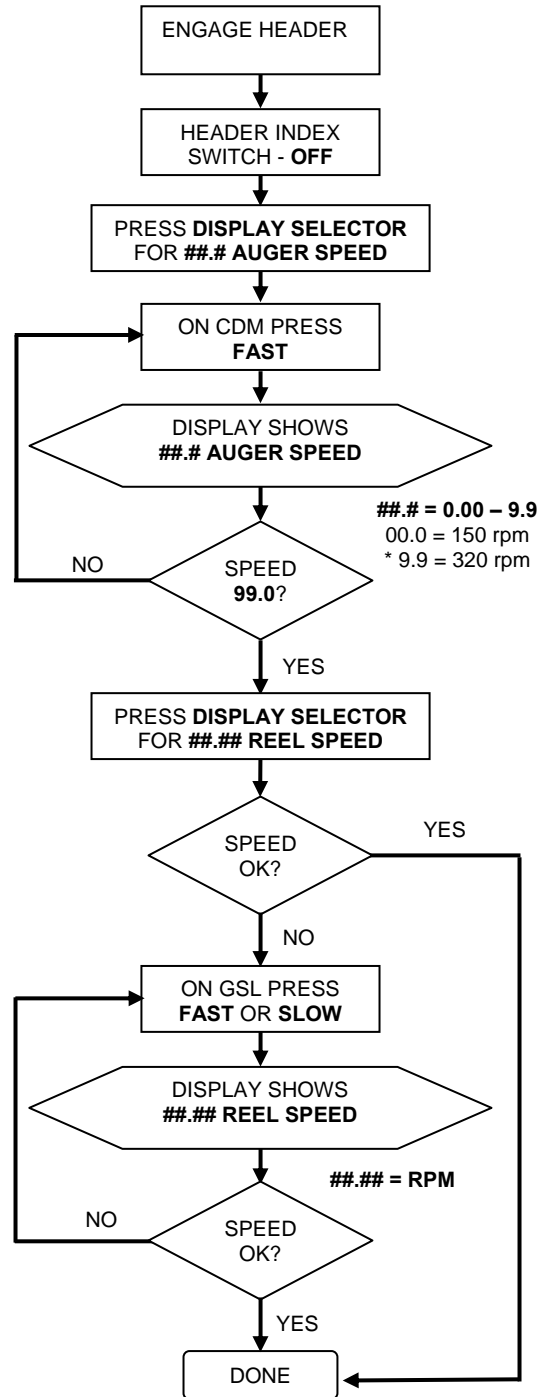
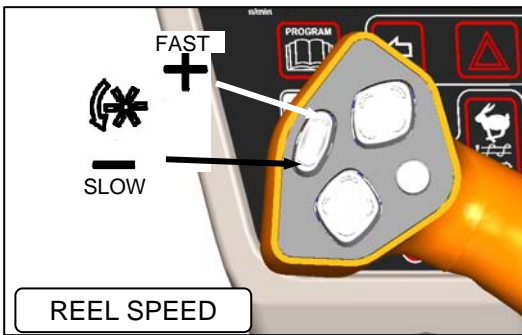
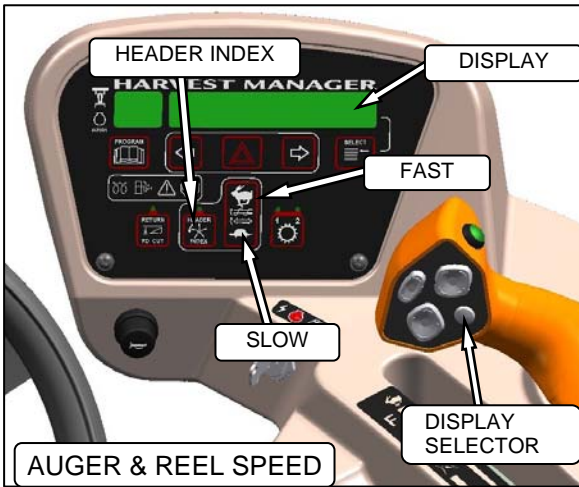

* Auger Speed Not To Exceed 320 rpm.

HEADER OPERATION – A SERIES

6.6.5 Knife Speed

The ideal cutting speed of the knife should be such that a clean cut is achieved. Crop types and conditions usually influence the knife and forward speeds.

The knife speed is manually set by making adjustments to the knife drive pump and has been pre-set at the factory. For optimum performance, adjust the knife speed according to the header being used. See the following table.

If the machine is equipped with the appropriate sensor and optional module, the CDM will notify the operator when the knife speed reaches an overload pre-set (usually 75% of knife speed). The pre-set can be changed on the CDM. Refer to Section 5.18.5 CDM Programming

NOTE

The knife speed should stay within the range specified for each header.

HEADER DESCRIPTION		KNIFE SPEED			
TYPE	SIZE	MINIMUM		MAXIMUM	
		RPM	SPM	RPM	SPM
Auger A40D	All	700	1400	950	1900
Auger A30D		775	1550		
Auger A30S		625	1250	775	1550

RPM = speed of wobble box pulley.

SPM = strokes per minute of knife (RPM x 2).

- a. Determine the knife speed as follows if the machine is not equipped with the optional module:



CAUTION

Check to be sure all bystanders have cleared the area.

1. Run engine at 2600 rpm with the header drive engaged and with ISC off.



2. Check wobble box pulley speed with a hand-held tachometer.
 3. Multiply the rpm reading by two for the knife speed in strokes per minute.
- b. Determine the knife speed as follows if the machine is equipped with the optional module:
1. Run engine at 2600 rpm with the header drive engaged and ISC off.



2. Press SELECTOR button on the GSL until the CDM displays the knife speed in SPM.
- c. If required, adjust knife speed as follows:



DANGER

Stop engine and remove key from ignition before leaving operator's seat for any reason. A child or even a pet could engage an idling machine.

1. Shutdown engine.

(continued next page)

HEADER OPERATION – A SERIES

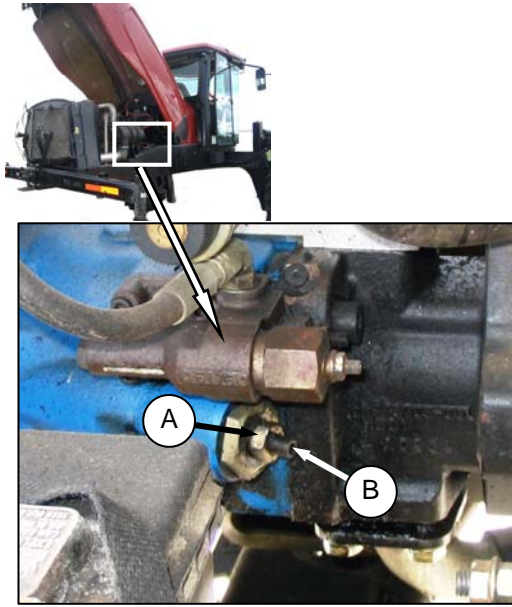

2. Loosen jam-nut (A).
3. Turn adjuster screw (B) clockwise (screw in) to decrease knife speed, and counter-clockwise (screw out) to increase the knife speed.

NOTE

One turn of the adjuster screw will change the knife speed by approximately 116 strokes per minute, or the wobble box pulley speed by 58 revolutions per minute.

4. Once adjustment has been made re-torque jam nut (A) as shown.
- d. Start engine and recheck knife speed.

7 MAINTENANCE/SERVICE

The following instructions are provided to assist the operator in the use of the M100 Windrower. Detailed maintenance, service, and parts information are contained in the Service Instruction Manual and Parts Catalog that are available from your dealer.

7.1 PREPARATION FOR SERVICING



WARNING

To avoid personal injury, before servicing adapter/header or opening drive covers:

- Fully lower the header. If necessary to service in the raised position, always engage lift cylinder stops.
- Disengage drives.
- Stop engine and remove key.
- Wait for all moving parts to stop.

7.1.1 Welding Precautions

IMPORTANT

High currents and voltage spikes associated with welding can cause damage to electronic components. Before welding on any part of the windrower or an attached header, disconnect all electronic module harness connections as well as the battery cables. These electronic modules include;

- Engine Control Module (ECM)
- Cab Display Module (CDM)

7.2 RECOMMENDED SAFETY PROCEDURES

- Wear close-fitting clothing and cover long hair. Never wear dangling items such as scarves or bracelets.

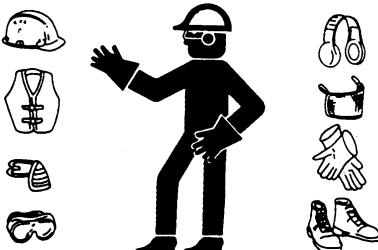

- Wear protective shoes with slip-resistant soles, a hard hat, protective glasses or goggles and heavy gloves.

- If more than one person is servicing the machine at the same time, be aware that rotating a driveline or other mechanically driven component by hand (for example, accessing a lube fitting)



will cause drive components in other areas (belts, pulleys, and sickle) to move. Stay clear of driven components at all times.

- Be prepared if an accident should occur. Know where the first aid kit and fire extinguishers are located and how to use them.



- Keep the service area clean and dry. Wet or oily floors are slippery. Wet spots can be dangerous when working with electrical equipment. Be sure all electrical outlets and tools are properly grounded.



- Use adequate light for the job at hand.
- Replace all shields removed or opened for service.
- Park on a level surface when possible. Block wheels securely.
- Use only service and repair parts made or approved by the equipment manufacturer. Substituted parts may not meet strength, design or safety requirements.
- Keep the machine clean. Never use gasoline, naphtha or any volatile material for cleaning purposes. These materials may be toxic and/or flammable.

MAINTENANCE/SERVICE

7.3 MAINTENANCE SPECIFICATIONS

7.3.1 Recommended Fluids, Fuel, and Lubricants

7.3.1.1 Fuel

FUEL	SPEC	SULPHUR (by weight)	WATER & SEDIMENT (by weight)	CETANE NO.	LUBRI CITY
Diesel Grade No.2	ASTM D-975	As Per Spec	As Per Spec	As Per Spec	As Per Spec
Diesel Grade No.1 & 2 mix *	n/a	1% Max. 0.5% Max. Preferred	0.1% Max.	45-55 Cold Weather/ High Alt.	460 HFRR

* Optional when operating temp below 0°C. (32°F.).

In extreme situations, when available fuels are of poor quality or problems exist which are peculiar to certain operations, additives can be used. However, the engine manufacturer recommends consultation with the fuel supplier or engine manufacturer prior to use of fuel additives. Among the situations where additives can prove useful are the following:

- A cetane improver additive can be used with low cetane fuels.
- A wax crystal modifier can help with fuels with high cold filter plugging points (CFPP).
- An anti-icer can help prevent ice formation in wet fuel during cold weather.
- An anti-oxidant or storage stability additive can help with fuel system deposits and poor storage stability.
- A lubricity enhancer can be used to increase the lubricity of fuels so that they meet the requirements given in the table on the previous page.

Diesel fuel conditioner is available from your dealer.

7.3.1.2 Fluids

FLUID	SPEC	DESCRIPTION	USE
Anti-Freeze	ASTM D-4985	Ethylene Glycol With SCA	Engine Coolant *
Air Conditioning Refrigerant	R134A	Refrigerant	Cab Air Conditioning System.
Compressor Oil	SP-15	Compressor Oil	Cab Air Conditioning Compressor Lubricant

* Mix with equal parts of high quality, soft, de-ionized, or distilled water.

7.3.1.3 Lubricants

LUBRICANT	SPEC/DESCRIPTION	USE
Grease	SAE Multi-Purpose. High Temp. Extreme Pressure (EP2) Performance With 1% Max Molybdenum Disulphide (NLGI Grade 2). Lithium Base	As Required Unless Otherwise Specified.
Engine Oil	SAE 15W40 Compliant With SAE Specs For API Class SJ And CH-4 Engine Oil.	Engine Crankcase
Hydraulic Oil	SAE 15W40 Compliant With SAE Specs For API Class SJ And CH-4 Engine Oil	Windrower Drive. Header Drive.
Gear Lubricant	SAE 85W-140 API Service Class GL-5. Extreme Pressure Gear Lubricant	Drive Wheel Gears Before Initial Change.
	SAE 75W-90 API Service Class GL-5. Fully Synthetic Gear Lubricant (SAE J2360 Preferred)	Drive Wheel Gears After Initial Change.

7.3.1.4 Capacities

ITEM	CAPACITY
Fuel Tank	97 U.S. Gallons (378 liters)
Hydraulic Reservoir	11.5 U.S. Gallons (45 liters)
Drive Wheel	1.5 U.S. Quarts (1.4 liters)
Engine Cooling System	5.3 U.S. Gallons (20 liters)
Engine Crankcase	7.6 U.S. Quarts (7 liters)
Air Cond. Refrigerant	3.6 lb (1.63 kg)
Air Cond. Compressor	8.1 fl. oz. (240 cc)

7.3.1.5 Storage

Your machine can operate at top efficiency only if clean fuel and lubricants are used.

- Use clean containers to handle all fuels and lubricants.
- Store in an area protected from dust, moisture, and other contaminants.
- Buy good quality, clean fuel from a reputable dealer.
- Avoid storing fuel over long periods of time. If you have a slow turnover of fuel in windrower tank or supply tank, add fuel conditioner to avoid condensation problems.
- Store fuel in a convenient place away from buildings.

MAINTENANCE/SERVICE

7.3.2 Recommended Torques

- Tighten all bolts to the torques specified in chart unless otherwise noted throughout this manual.
- Check tightness of bolts periodically, using bolt torque chart as a guide.
- Replace hardware with the same strength bolt.
- Torque figures are valid for non-greased or non-oiled threads and heads unless otherwise specified. Do not grease or oil bolts or capscrews unless specified in this manual. When using locking elements, increase torque values by 5%.

7.3.2.1 SAE Bolts

BOLT DIA. "A" in.	NC BOLT TORQUE*			
	SAE 5		SAE 8	
	lbf-ft	N·m	lbf-ft	N·m
8 1/4	9 9	10 12	11 11	12 15
13 5/1	14 18	15 24	16 25	17 34
18 3/8	19 32	20 43	21 41	22 56
23 7/1	24 50	25 68	26 70	27 95
28 1/2	29 75	30 10	31 10	32 14
33 9/1	34 11	35 14	36 14	37 20
38 5/8	39 15	40 20	41 20	42 27
43 3/4	44 26	45 35	46 36	47 49
48 7/8	49 42	50 56	51 60	52 81
53 1	54 64	55 86	56 89	57 12

* Torque categories for bolts and capscrews are identified by their head markings.

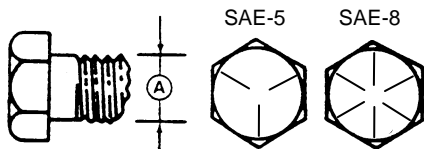

57.1.1.1 Metric Bolts

BOLT DIA. "A"	NC BOLT TORQUE*			
	8.8		10.9	
	lbf-ft	N·m	lbf-ft	N·m
M3	0.4	0.5	1.3	1.8
M4	2.2	3	3.3	4.5
M5	4	6	7	9
M6	7	10	11	15
M8	18	25	26	35
M10	37	50	52	70
M12	66	90	92	125
M14	103	140	148	200
M16	166	225	229	310
M20	321	435	450	610
M24	553	750	774	1050
M30	1103	1495	1550	2100
M36	1917	2600	2710	3675

* Torque categories for bolts and capscrews are identified by their head markings.

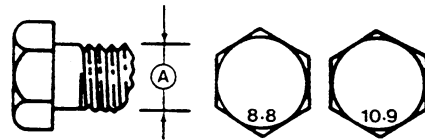

MAINTENANCE/SERVICE

57.1.1.2 Flare Type Hydraulic Fittings

- a. Check flare and flare seat for defects that might cause leakage.
- b. Align tube with fitting before tightening.
- c. Lubricate connection and hand tighten swivel nut until snug.
- d. To prevent twisting the tube(s), use two wrenches. Place one wrench on the connector body and with the second tighten the swivel nut to the torque shown.

SAE NO.	TUBE SIZE O.D. (in.)	THD SIZE (in.)	NUT SIZE ACROSS FLATS (in.)	TORQUE VALUE*		RECOMMENDED TURNS TO TIGHTEN (AFTER FINGER TIGHTENING)	
				ft·lbf	N·m	Flats	Turns
3	3/16	3/8	7/16	6	8	1	1/6
4	1/4	7/16	9/16	9	12	1	1/6
5	5/16	1/2	5/8	12	16	1	1/6
6	3/8	9/16	11/16	18	24	1	1/6
8	1/2	3/4	7/8	34	46	1	1/6
10	5/8	7/8	1	46	62	1	1/6
12	3/4	1-1/16	1-1/4	75	102	3/4	1/8
14	7/8	1-3/8	1-3/8	90	122	3/4	1/8

* The torque values shown are based on lubricated connections as in reassembly.

57.1.1.3 O-ring Type Hydraulic Fittings

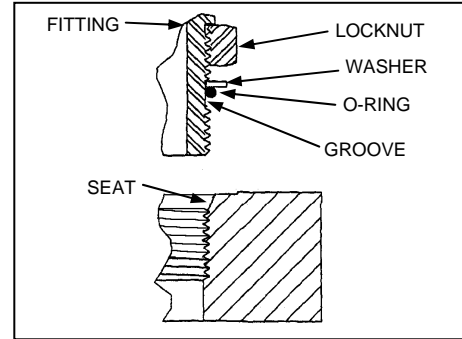

- a. Inspect O-ring and seat for dirt or obvious defects.

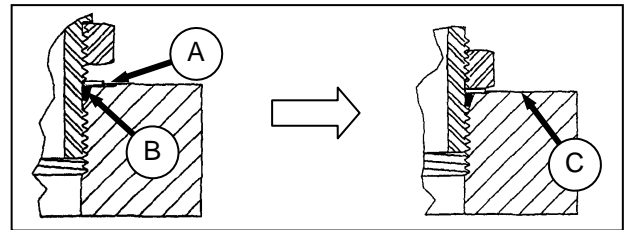

- b. On angle fittings, back off the lock nut until washer (A) bottoms out at top of groove (B) in fitting.
- c. Hand tighten fitting until back up washer (A) or washer face (if straight fitting) bottoms on part face (C) and O-ring is seated.
- d. Position angle fittings by unscrewing no more than one turn.
- e. Tighten straight fittings to torque shown.
- f. Tighten angle fittings to torque shown in the following table while holding body of fitting with a wrench.

SAE NO.	THD SIZE (in.)	NUT SIZE ACROSS FLATS (in.)	TORQUE VALUE*		RECOMMENDED TURNS TO TIGHTEN (AFTER FINGER TIGHTENING)	
			ft·lbf	N·m	Flats	Turns
3	3/8	1/2	6	8	2	1/3
4	7/16	9/16	9	12	2	1/3
5	1/2	5/8	12	16	2	1/3
6	9/16	11/16	18	24	2	1/3
8	3/4	7/8	34	46	2	1/3
10	7/8	1	46	62	1-1/2	1/4
12	1-1/16	1-1/4	75	102	1	1/6
14	1-3/16	1-3/8	90	122	1	1/6
16	1-5/16	1-1/2	105	142	3/4	1/8
20	1-5/8	1-7/8	140	190	3/4	1/8
24	1-7/8	2-1/8	160	217	1/2	1/12

* The torque values shown are based on lubricated connections as in reassembly.

MAINTENANCE/SERVICE

57.1.2 Conversion Chart

QUANTITY	INCH-POUND UNITS		FACTOR	SI UNITS (METRIC)	
	UNIT NAME	ABBR.		UNIT NAME	ABBR.
Area	acres	acres	$\times 0.4047 =$	hectares	ha
Flow	US gallons per minute	(gpm)	$\times 3.7854 =$	liters per min	L/min
Force	pounds force	lbf	$\times 4.4482 =$	Newtons	N
Length	inch	in.	$\times 25.4 =$	millimeters	mm
	foot	ft	$\times 0.305 =$	meters	m
Power	horsepower	hp	$\times 0.7457 =$	kilowatts	kW
Pressure	pounds per square inch	psi	$\times 6.8948 =$	kilopascals	kPa
			$\times .00689 =$	megapascals	MPa
Torque	pound feet or foot pounds	lbf-ft or ft-lbf	$\times 1.3558 =$	newton meters	N·m
	pound inches or inch pounds	lbf-in. or in-lbf	$\times 0.1129 =$	newton meters	N·m
Temperature	degrees Fahrenheit	°F	$(F - 32) \times 0.56 =$	Celsius	°C
Velocity	feet per minute	ft/min	$\times 0.3048 =$	meters per min	m/min
	feet per second	ft/s	$\times 0.3048 =$	meters per sec	m/s
	miles per hour	mph	$\times 1.6063 =$	kilometers per hour	km/h
Volume	US gallons	US gal.	$\times 3.7854 =$	liters	L
	ounces	oz.	$\times 29.5735 =$	milliliters	ml
	cubic inches	in. ³	$\times 16.3871 =$	cubic centimeters	cm ³ or cc
Weight	pounds	lb	$\times 0.4536 =$	kilograms	kg

MAINTENANCE/SERVICE

57.2 ENGINE COMPARTMENT HOOD

The engine hood has two open positions. The lowest is for general maintenance such as checking and adding fluid, servicing the cooling box, etc. The highest position accommodates full access to the engine bay.

- a. Open the hood at the lowest position as follows:

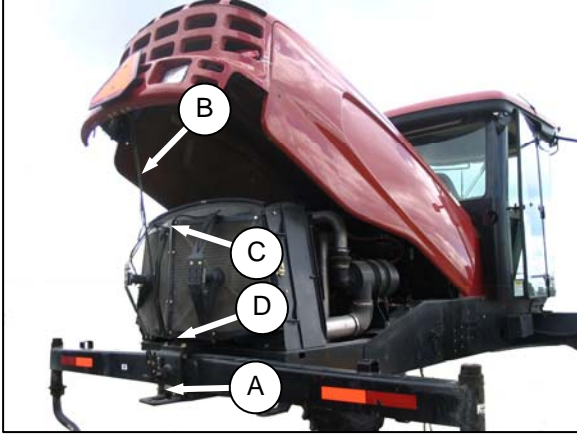

1. Locate latch (A) behind grill and lift to release hood.
2. Raise hood until strap (B), which should be looped under hooks (C) and (D), stops it at approximately a 40 degree angle.

- b. To close hood:

1. Pull down on strap (B), grasp the hood when within reach and lower until hood engages latch (A).

- c. Open the hood at the highest position as follows:
1. Open hood to lowest position.

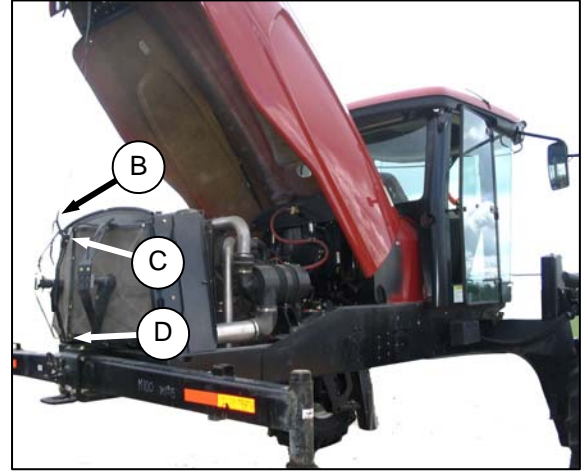

2. Remove strap from hooks (C) and (D) and allow hood to raise fully to approximately 65 degrees.
- d. To close hood:
1. Grasp the strap at (B) and loop under upper hook (C).
 2. Pull down on strap and loop under lower hook (D).

IMPORTANT

Failure to hook strap may result in it becoming entangled with the screen cleaners or the latch.

3. Pull down on strap, grasp the hood when within reach and lower until hood engages latch (A).

MAINTENANCE/SERVICE

57.3 MAINTENANCE PLATFORM

A swing away platform/stair unit is provided on the left side of the windrower for access to the operator's station and engine bay maintenance.

57.3.1 Opening/Closing Platform

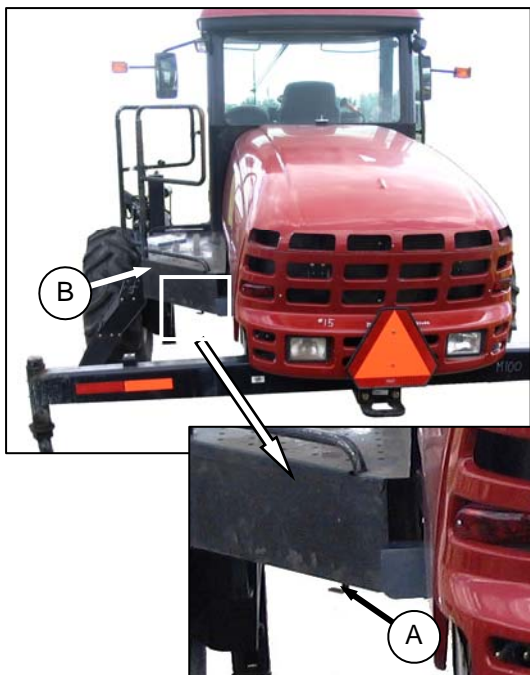

- a. Push latch (A) down and pull platform (B) toward walking beam until it stops and latch re-engages in open position.
- b. To move platform back to closed position, release latch (A) and move platform forward until it stops and latch re-engages.

57.3.2 Opening/Closing Platform for Major Servicing

To improve access to the hydraulics plumbing, the platform can be swung away from the windrower.

To Open:



- a. Open engine compartment hood to lowest position.

IMPORTANT

Failure to open hood will result in damage to the hood when the platform is repositioned.

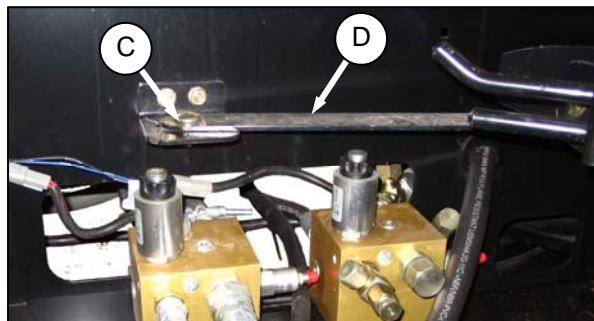

- b. Unlock latch (A) and move platform (B) toward open position.
- c. Remove nut and bolt (C) and swing link (D) clear of valve block.

(continued next page)

MAINTENANCE/SERVICE

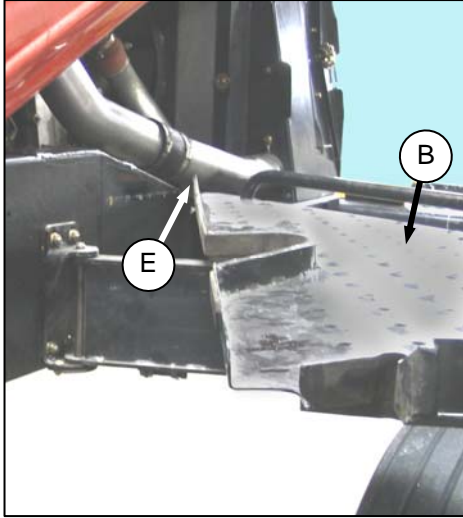

- d. At the same time pull front end of platform away from frame while moving it towards the walking beam. Aft corner (E) of platform should project slightly into engine bay when optimum opening is reached.



CAUTION

Do not stand on the platform in the unlocked position. It is unstable and may result in a fall.

- e. Swing link (D) under platform.

To Close:

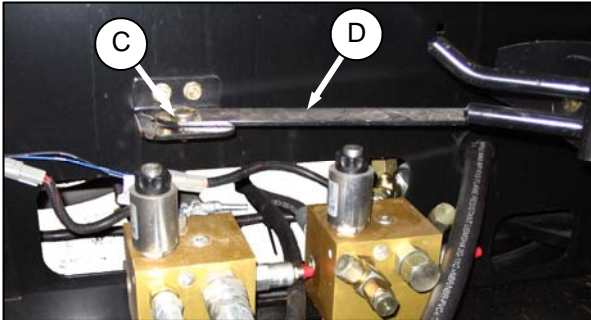

- Swing link (D) out from under platform all the way forward.
- Move platform front end inboard while moving it away from the walking beam.
- Position link (D) on bracket and install bolt and nut (C). Do not fully tighten.
- Move platform to closed position, ensuring it is locked.
- Close engine compartment hood.

57.4 LUBRICATING THE WINDROWER



WARNING

To avoid personal injury, before servicing windrower or opening drive covers, follow procedures in Section 7.1, Preparation for Servicing.

Recommend Lubricant

LUBRICANT	SPEC	DESCRIPTION	USE
Grease	SAE Multi-Purpose.	High Temp. Extreme Pressure (EP2) Performance With 1% Max Molybdenum Disulphide (NLGI Grade 2), Lithium Base	As Required Unless Otherwise Specified.

The greasing points are marked on the machine by decals showing a grease gun and grease interval in hours of operation. See illustration below.

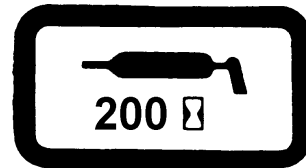

Log hours of operation and use the "Maintenance Checklist" provided to keep a record of scheduled maintenance. Refer to Section 7.13, Maintenance Schedule.

57.4.1 Procedure



DANGER

Stop engine and remove key from ignition before leaving operator's seat for any reason. A child or even a pet could engage an idling machine.

- Wipe grease fitting with a clean cloth before greasing, to avoid injecting dirt and grit.
- Inject grease through fitting with grease gun until grease overflows fitting, except where noted.
- Leave excess grease on fitting to keep out dirt.
- Replace any loose or broken fittings immediately.
- If fitting will not take grease, remove and clean thoroughly. Also clean lubricant passageway. Replace fitting if necessary.

MAINTENANCE/SERVICE

57.4.2 Lubrication Points

Refer to the illustrations on the following page for identifying the various locations that require lubrication.

High Temp. Extreme Pressure (EP2) Performance With 1% Max Molybdenum Disulphide (NLGI Grade 2).Lithium Base

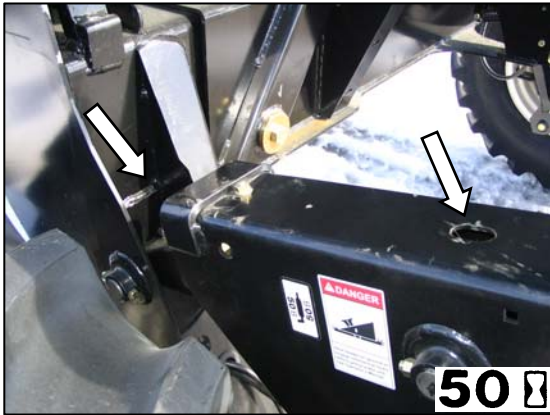

TOP LINK – TWO FITTINGS (BOTH SIDES)

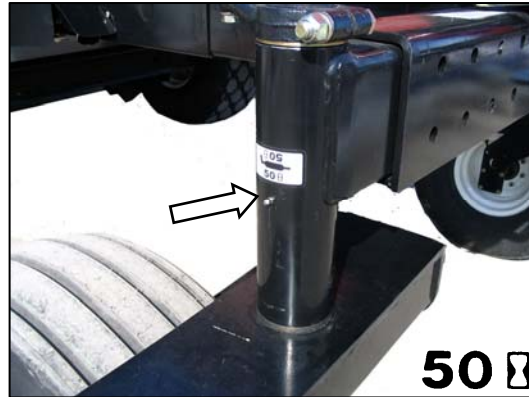

CASTER PIVOT (BOTH SIDES)



FORMED CASTER WHEEL BEARING 1 PLACE (BOTH WHEELS)



FORKED CASTER SPINDLE BEARINGS TWO PLACES (BOTH WHEELS)

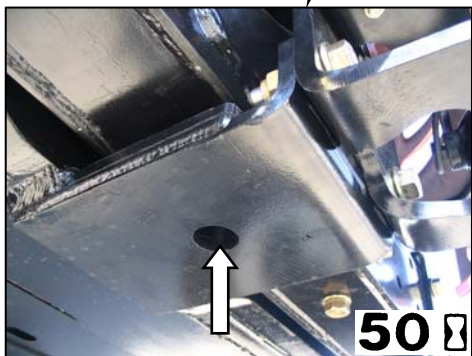

WALKING BEAM PIVOT)

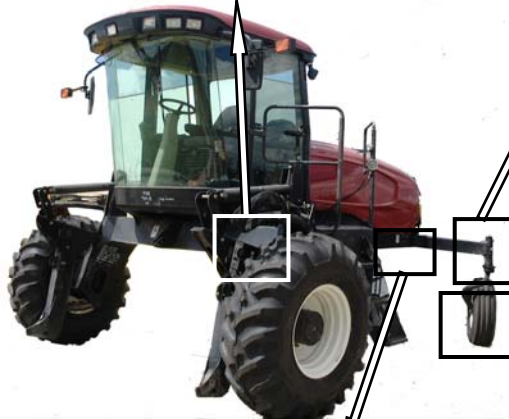

MAINTENANCE/SERVICE

57.5 OPERATOR'S STATION

57.5.1 Seat Belts

Keep the operator and trainer seat belts in good condition as follows:

- a. Keep sharp edges and items that can cause damage away from the belts.
- b. From time to time, check belts, buckles, retractors, tethers, slack take-up system and mounting bolts for damage.
- c. Replace all parts that have damage or wear.
- d. Replace belts that have cuts that can weaken the belt.
- e. Check that bolts are tight on the seat bracket or mounting.
- f. Keep seat belts clean and dry. Clean only with a soap solution and warm water. DO NOT use bleach or dye on the belts, as this may weaken the material.

57.5.2 Safety Systems

Perform the following checks on the operator's presence and engine lock-out systems annually or every 500 hours whichever occurs first.

57.5.2.1 Operator's Presence System

- a. With the windrower engine running, place the GSL in Neutral and turn the steering wheel until it locks.
- b. With everyone clear of the machine, engage header drive switch;
 1. After header drives are running, stand up out of the seat. In approximately 5 seconds the header should shut off.
 2. If not, the operator presence system requires adjustment. See your MacDon dealer.

NOTE

To restart the header, the operator must move the header engage switch to "OFF" position and back to the "ON" position again.

- c. With the windrower engine running, place the GSL in Neutral but out of N-DETENT;
 1. Stand up. After 2 seconds, the lower display will flash "NOT IN NEUTRAL" accompanied by a continuous loud tone. Move the GSL into N-DETENT to cancel the alarm.
 2. If there is no warning, the operator presence system requires adjustment. See your MacDon dealer.

- d. With the windrower in forward motion at approximately 2-3 mph;
 1. Stand up out of the seat.
 2. The CDM will flash "NO OPERATOR" on the upper line, and "ENGINE SHUTS DOWN 5...4...3...2...1...0" accompanied by a steady tone.
 3. If not, the operator presence system requires adjustment. See your MacDon dealer.

57.5.2.2 Engine Interlock

- a. With the engine shut down and the header drive switch engaged, try to start the engine. If the engine turns over, the system requires adjustment. See your MacDon dealer.
- b. With the engine shut down, steering wheel not centered, and the GSL in neutral but not in N-DETENT, try to start the engine. The CDM will flash "NOT IN NEUTRAL" on the display upper line, and "CENTER STEERING WHEEL" on the lower line, accompanied by a short beep with each flash, and the engine should not turn over. If the engine turns over, the system requires adjustment. See your MacDon dealer.

A properly functioning system should operate as follows, if not, see your MacDon dealer.

- The starter should engage ONLY when the GSL is in N-DETENT, steering wheel locked in the CENTER position, and the header drive switch is in the OFF position.
- Under the above conditions, the brake should engage and the machine should not move after engine start-up.
- The steering wheel should not lock with the engine running and the GSL is out of the N-DETENT.
- The machine should not move with the engine running and with the steering wheel still centered, when the GSL is pulled straight out of N-DETENT (not in forward or reverse).

MAINTENANCE/SERVICE

57.5.3 Traction Drive Adjustments



DANGER

Stop engine and remove key from ignition before leaving operator's seat for any reason. A child or even a pet could engage an idling machine.

57.5.3.1 GSL Fore-Aft Movement

The GSL should remain as positioned by the operator and yet can be moved without excessive force. The spring is set at the factory to 2.50 in. (64 mm) shown on the illustration. If necessary, adjust as follows:

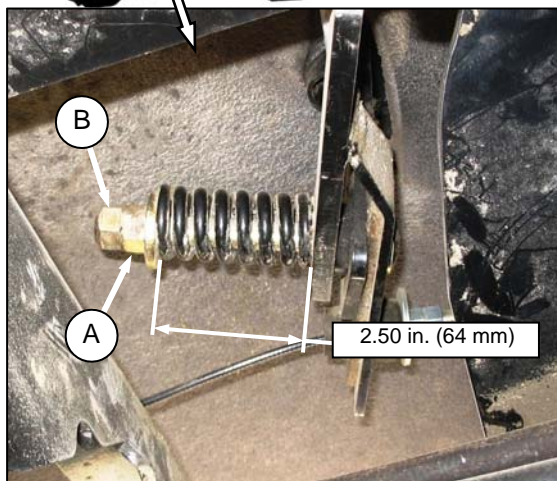

- Hold nut (A) from turning and loosen jam-nut (B).
- To increase the pivot resistance, turn the nut (A) clockwise to compress the spring.
- To decrease the resistance, turn the nut (A) counterclockwise to release the spring tension.
- Hold nut (A) from turning and tighten jam-nut (B).

57.5.3.2 Neutral Interlock Checks

A properly functioning system should operate as follows:

- The starter should engage ONLY when the GSL is in N-DETENT, steering wheel locked in the CENTER position, and the header drive switch is in the OFF position.
- Under the above conditions, the brake should engage and the machine should not move after engine start-up.
- The steering wheel should not lock with the engine running and the GSL is out of the N-DETENT.
- The machine should not move with the engine running and with the steering wheel still centered, when the GSL is pulled straight out of N-DETENT (not in forward or reverse).

Any problem with the neutral lock and steering controls could be caused by loose, worn, or improperly adjusted parts. Perform the following checks if the neutral interlock system is not functioning as described above. See Table next page.

IMPORTANT

When servicing this area, it is important to perform all of the checks to avoid missing the problem and providing only a temporary fix.

MAINTENANCE/SERVICE

PROBLEM	CHECK	ITEM NO.
Steering wheel will not lock in neutral.	GSL Position	7.7.3.3
	Cable Tension	7.7.3.4
	Neutral Lock	7.7.3.5
	Neutral Start Switch	7.7.3.6
Ground speed lever will not go into reverse or forward.	Cable Tension	7.7.3.4
Ground speed lever rattles in neutral	Cable Tension	7.7.3.4
	Neutral Lock	7.7.3.5
Ground speed lever not spring loaded towards the center of forward travel slot	Cable Tension	7.7.3.4
	Neutral Lock	7.7.3.5
Steering wheel locks in neutral, but neutral start switch does not compress	Neutral Start Switch	7.7.3.6
	Neutral Lock Adjust Bolts	7.7.3.7
	Cable Tension	7.7.3.4
	GSL Position	7.7.3.3
Machine "grows" severely or moves after engine start-up.	Neutral Lock	7.7.3.5
	Perform Neutral Set-up Procedure.	7.7.4
	Neutral Start Switch	7.7.3.6
	Neutral Lock Adjust Bolts	7.7.3.7
Steering wheel locks in neutral only after several left to right rotations of wheel	Cable Tension	7.7.3.4
	GSL Fore-Aft Movement	7.7.3.1
	GSL Position	7.7.3.3
	Neutral Lock	7.7.3.5
	Loose Hardware	7.7.3.8
	Perform Neutral Set-up Procedure.	7.7.4
Steering wheel locks in neutral only after several left to right rotations of wheel	Neutral Lock Adjust Bolts	7.7.3.7
	Cable Tension	7.7.3.4
	GSL Position	7.7.3.3
	Neutral Lock	7.7.3.5
Steering wheel locks in neutral only after several left to right rotations of wheel	Perform Neutral Set-up Procedure.	7.7.4

MAINTENANCE/SERVICE

57.5.3.3 GSL Position



The GSL should be centered fore-aft (A) in the N-Detent slot when the steering wheel is centered and locked.

If necessary, adjust as follows:

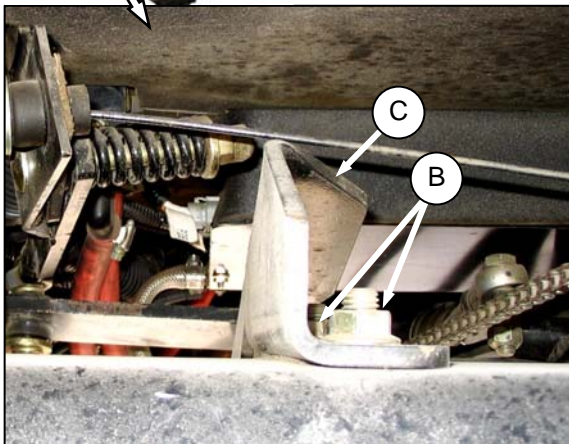

IMPORTANT

Neutral Interlock must be properly adjusted before adjusting GSL position.

- Lock pintle arms.
- Loosen nuts (B).
- Hold GSL in center of N-Detent slot to locate support (C).
- Tighten nuts (B) and torque to 80-90 ft-lbf (108-122 Nm).

57.5.3.4 Cable Tension



The GSL (D) should easily move into the N-Detent (E) by itself, and the cable (F) should be tight when the GSL is at the right hand side of the neutral detent on side console. The neutral start switch should also be fully compressed. If the cable is too tight, it will prevent the neutral start switch from fully compressing and prevent proper engagement of adjustment bolts on pintle arm.

Adjust the cable tension as follows:

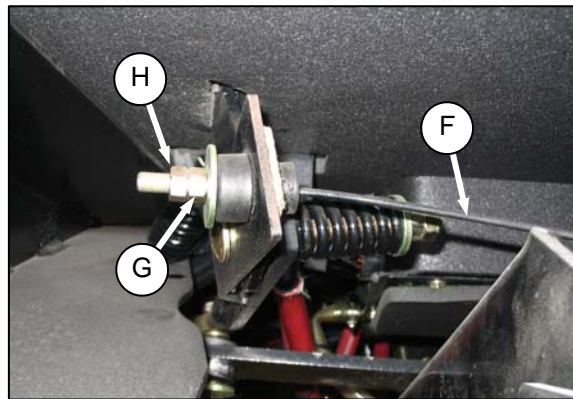

- Hold nut (G) from turning and loosen jam-nut (H).
- To increase the tension, turn the nut (G) clockwise.
- To decrease the cable tension, turn the nut (G) counterclockwise.
- Hold nut (G) from turning and tighten jam-nut (H).

MAINTENANCE/SERVICE

57.5.3.5 Neutral Lock Structure

- a. Check for proper movement of interlock support structure as follows:

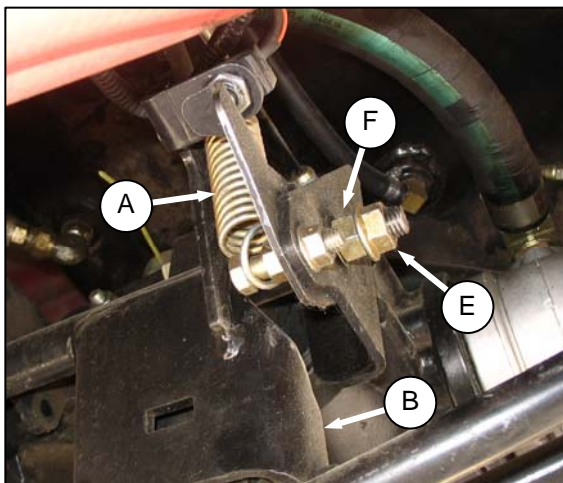

1. Disconnect spring (A) to unload pivots.
2. Check that support (B) rotates freely and that there is no fore-aft movement of structure.
3. If no adjustment is required, reconnect spring (A).

- b. If necessary, adjust as follows:

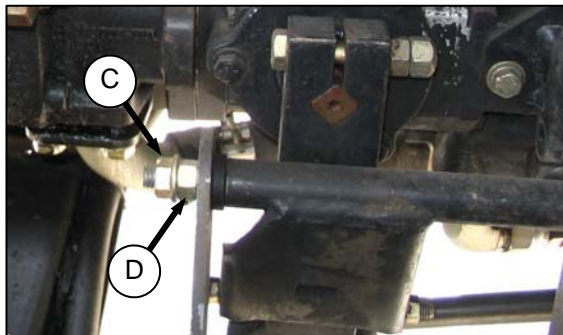

1. Loosen outer nut (C).
2. Turn inner nut (D) until washer just contacts the plastic bushing. This pivot must allow free rotation of the support structure.
3. Hold inner nut (D) with a wrench and tighten outer nut (C) against nut (D).
4. Loosen outer nut (E).
5. Turn inner nut (F) until washer contacts the front support. Check again for free rotation of the structure with no fore-aft movement.
6. Hold inner nut (F) with a wrench and tighten outer nut (E) against inner nut (F).
7. Torque outer nuts (C) & (E) to 60-70 ft·lbf (80-90 Nm).
8. Reconnect spring (A).

57.5.3.6 Neutral Start Switch

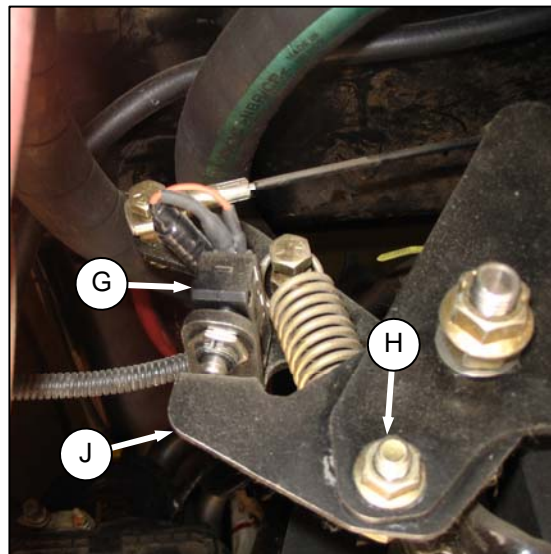

The neutral start switch (G) must be closed before the engine can be started. The switch is closed when the neutral interlock on the pump is activated by positioning the GSL into N-DETENT and locking the steering wheel in centre position. When the switch closes, and machine starts and runs, the brakes continue to be applied to the drive wheels as park brake solenoid 3 is energized preventing brake release. The neutral switch is located on the frame adjacent to the hydrostatic transmission.

- a. Check that electrical connections are good at neutral start switch (G).
- b. Check that the plunger of switch is fully compressed when the steering is locked and the GSL is fully in N-DETENT. Adjust switch support if required as follows:
 1. Loosen nut (H) and adjust support (J) as required.
 2. Tighten nut (H).

IMPORTANT

Do not over-adjust switch support, as this will prevent pintle arms from locking.

MAINTENANCE/SERVICE

57.5.3.7 Neutral Lock Adjustment Bolts

The neutral lock adjustment bolts must fully engage the pintle arms. Check and adjust as follows:

- Ensure GSL is in N-DETENT position and the steering wheel is locked in the centre position.
- Shut down the engine.

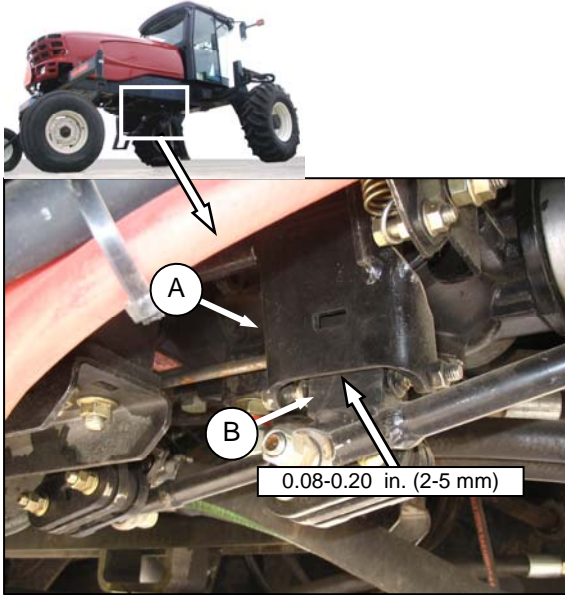

- Using a feeler gauge, gap between pivot channel (A) and rear pintle arm (B) should be 0.04-0.20 inch (1-5 mm).
- If required, adjust the interlock release cable (C) as follows:

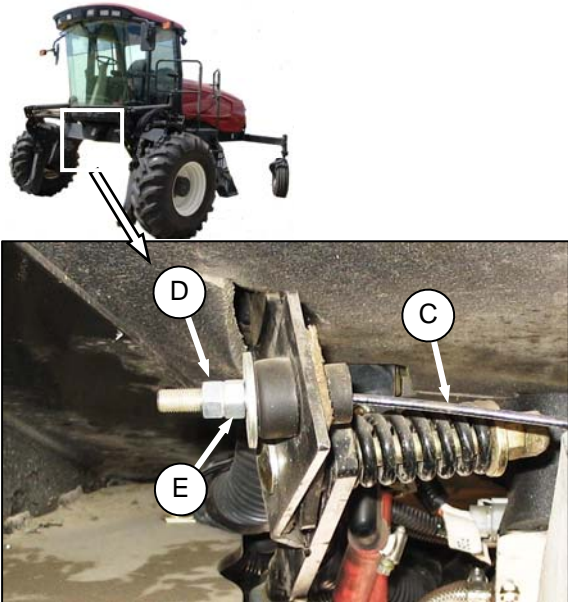

- Loosen jam nut (D) and turn nut (E) counterclockwise to increase the gap and clockwise to decrease.
- Tighten jam nut (D) against nut (E).
- Check neutral start switch plunger is fully depressed.

57.5.3.8 Loose Hardware

Check all hardware (not included in the previous checks) is properly tightened to torque specifications on ground speed controls, control rods, pump pintle arms and neutral start mechanisms.

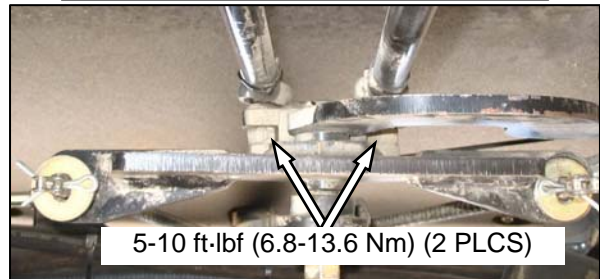
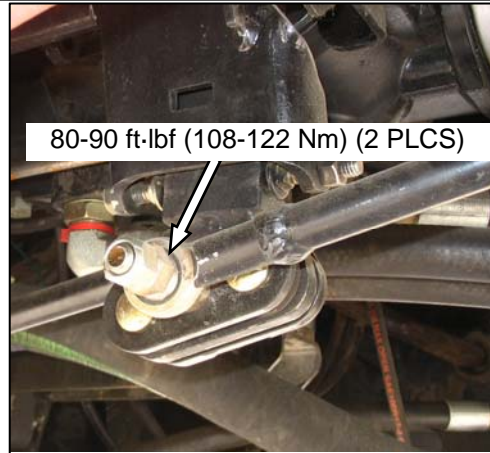
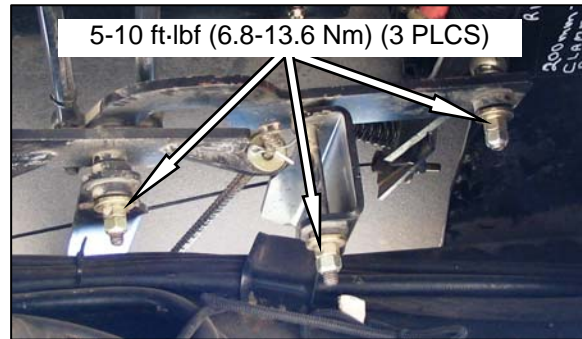

MAINTENANCE/SERVICE

57.5.4 Neutral Set-Up Procedure

This procedure should be performed only after the preceding checks and adjustments have failed to solve the neutral lock/steering problem.

This procedure will eliminate machine movement in neutral and will improve neutral locking ability.



CAUTION

Use jack-stands with a minimum capacity of 3 tons (2720 kg) to provide adequate support for machine.



DANGER

Never attempt neutral set-up procedure without raising front wheels off the ground so they are free to turn. Failure to raise front wheels will result in machine runaway, causing severe personal injury or death.

- Detach header and remove hay conditioner forming shields from under windrower.
- Raise front of machine high enough to allow both wheels to turn freely and support with jack-stands. See "Jacking Procedure" under Wheel & Tire Maintenance in this section.
- Open maintenance platform.

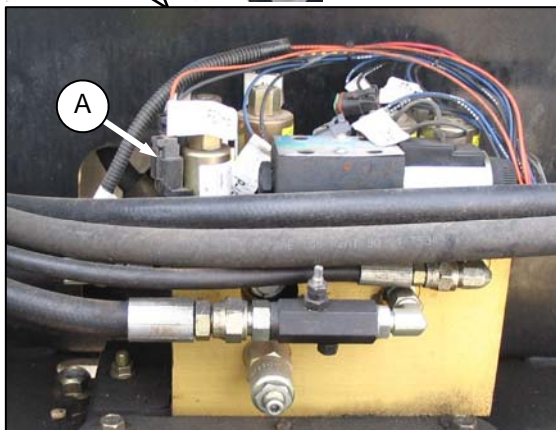

- Disconnect electrical connector V3 (wire 2-2002) (A) at brake solenoid 3.

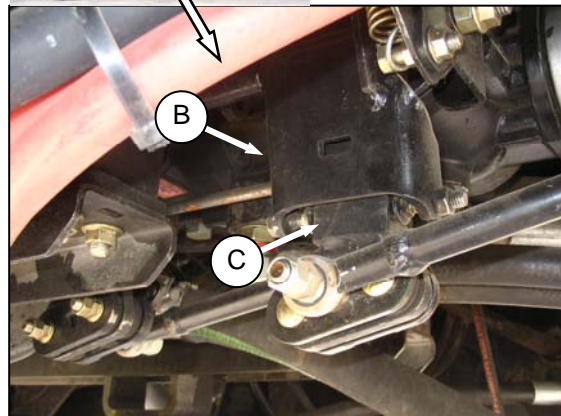

- Ensure GSL is fully in N-DETENT and that neutral lock mechanism (B) has engaged pintle arms (C).
- Start engine and run at 1100 rpm.
- Adjust REAR pintle interlock as follows:

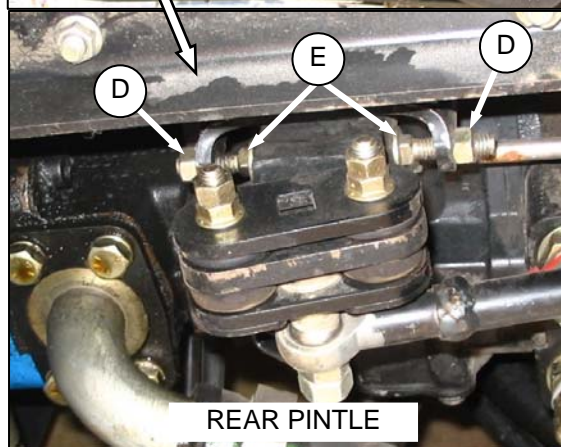
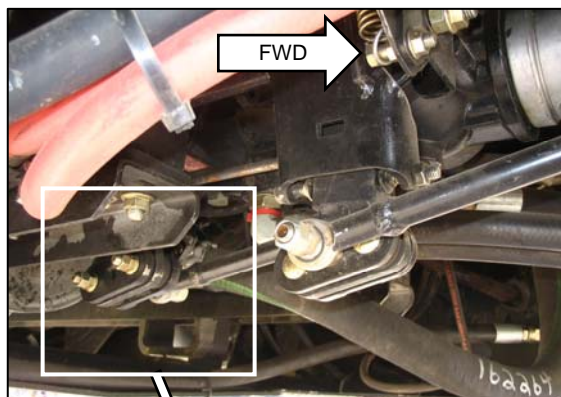

- Loosen jam-nuts (D) and back off adjusting bolts (E) in rear pintle arm.

(continued next page)

MAINTENANCE/SERVICE

2. Move pintle arm a small amount forward and hold so that LH wheel rotates forward for 2 or 3 seconds.
3. Move pintle arm a small amount rearward and hold so that LH wheel rotates backward for 2 or 3 seconds.
4. Position pintle arm so that the LH wheel remains stationary and the pump is the quietest to obtain the exact neutral position.
5. Turn the forward adjusting bolt (E) by hand until it contacts the pintle arm.
6. Move the pintle arm firmly against the adjusting bolt to check the setting – it's acceptable for the LH wheel to just begin to creep forward. Hand tighten the jam-nut (D) at the forward adjusting bolt.
7. Return pintle arm to the neutral position.
8. Turn the rear adjusting bolt (E) by hand until it contacts the pintle arm.
9. Move the pintle arm firmly against the rear adjusting bolt to check the setting – it's acceptable for the LH wheel to just begin to creep backward. Hand tighten the jam-nut (D) at the rear adjusting bolt.
10. Verify the adjusting bolt setting by again moving the pintle arm forward, then rearward to check that the LH wheel just begins to creep in both cases.
11. Fully tighten jam-nuts on both adjusting bolts.
12. Check that the rear interlock engages and disengages freely onto the pintle arm in the neutral position.

- h. Adjust FRONT pintle interlock (actuates RH wheel) using same procedure for the REAR pintle:

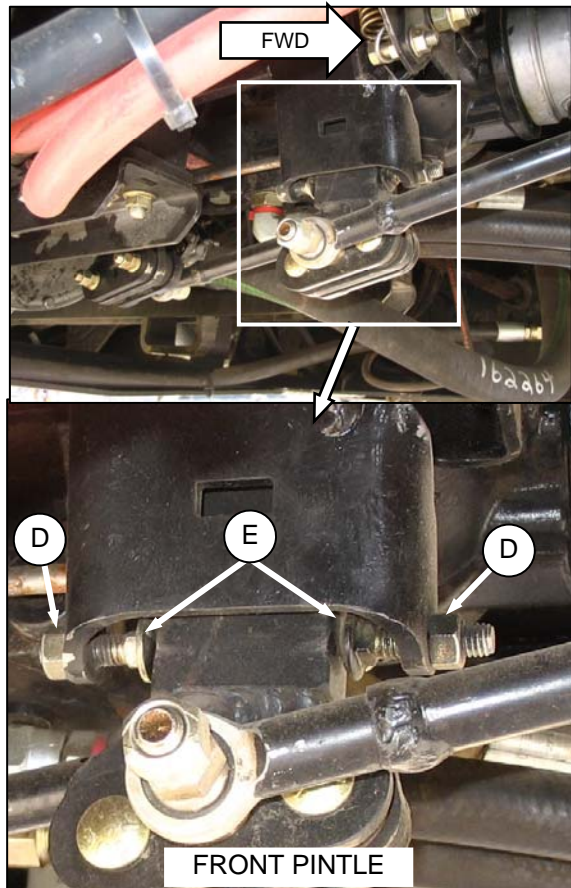

- i. Apply a small amount of grease to the head of the adjusting bolts.
- j. Shut-off engine.
- k. Check GSL position in N-DETENT and adjust as necessary. See 7.7.3.3.
- l. Reconnect connector V3 at brake solenoid 3.
- m. Close maintenance platform.
- n. Lower machine to ground.

MAINTENANCE/SERVICE

57.5.5 HVAC System

57.5.5.1 Fresh Air Intake Filter

The fresh air filter is located under the cab roof behind the rear window and should be serviced daily. Service the filter as follows:



DANGER

Stop engine and remove key from ignition before leaving operator's seat for any reason. A child or even a pet could engage an idling machine.

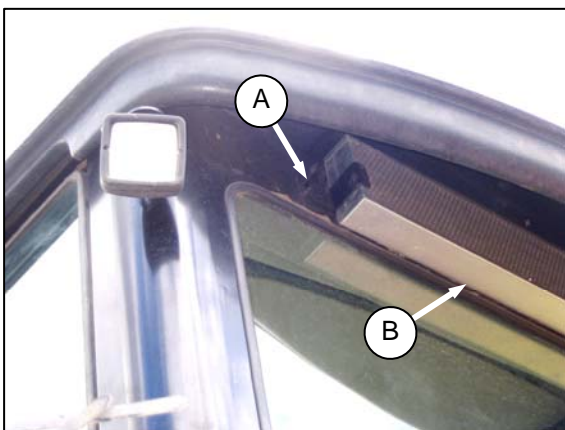

- a. Loosen knob (A) and slide retainer out to release filter (B) from rear of cab roof.



CLEANING AIR FILTER

- b. Tap filter gently on a flat surface, dirty side down. Do not tap on a tire, treads may damage filter pleats.

- c. Direct compressed air (100 psi [700 kPa] maximum) through filter in opposite direction of air flow arrows.
- d. Wash filter as required:
 1. Soak 15 minutes in warm water (not over 100°F [40°C]) with Filter Element Cleaner, (Donaldson D 1400 or equivalent).
 2. Rinse thoroughly with clean water, (maximum pressure 40 psi [275 kPa]).
 3. Shake excessive water from filter and allow element to dry. Do not use compressed air to dry filter; it may rupture the wet element. Protect element from freezing until dry.
- e. Inspect filter before installing as follows:
 1. Hold a bright light on one side element and check carefully for holes. Discard any element which shows the slightest hole.
 2. Be sure outer screen is not dented. Vibration would quickly wear a hole in the filter.
 3. Be sure filter gasket is in good condition. If gasket is damaged or missing, replace element
- f. If element is coated with oil or soot, replace the element.
- g. Reinstall filter, making sure air flow arrows point towards cab.

MAINTENANCE/SERVICE

57.5.5.2 Return Air Cleaner

The return air filter is located behind the operator's seat on the cab wall and should be serviced every 100 hours as follows:



DANGER

Stop engine and remove key from ignition before leaving operator's seat for any reason. A child or even a pet could engage an idling machine.

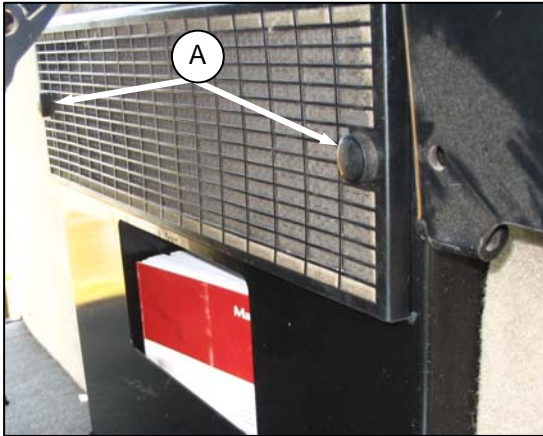

- a. Unscrew the two knobs (A) attaching cover and filter to cab wall, and pull off the cover and filter assembly.

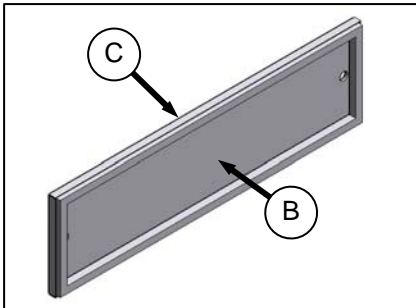

- b. Separate the filter (B) from the cover (C).
- c. Clean the filter as follows:
 1. Mix a solution of warm water and detergent in a suitable container so that the filter can soak for a few minutes.
 2. Agitate to flush out the dirt.
 3. Rinse with clean water and dry with compressed air.
 4. Inspect filter for damage, separation, and holes. Replace if damaged.
- d. Assemble the filter (B) and cover (C) and position on cab wall over opening.
- e. Secure to cab wall with knobs (A).

57.5.5.3 A/C Condenser

The air conditioning condenser should be cleaned daily with compressed air and more frequent cleaning may be necessary in severe conditions. Cleaning the condenser can be done at the same time as the radiator, oil cooler, and charge air cooler. Refer to Section 7.9.2 Cooling Box Maintenance.

57.5.5.4 A/C Evaporator

The air conditioning evaporator should be checked annually for cleanliness. If the air conditioning system produces insufficient cooling, a possible cause is clogged evaporator fins. Fins will clog up from the side opposite the blowers.

The evaporator is located inside the heating air conditioning unit under the cab. To clean the evaporator, proceed as follows:



DANGER

Stop engine and remove key from ignition before leaving operator's seat for any reason. A child or even a pet could engage an idling machine.

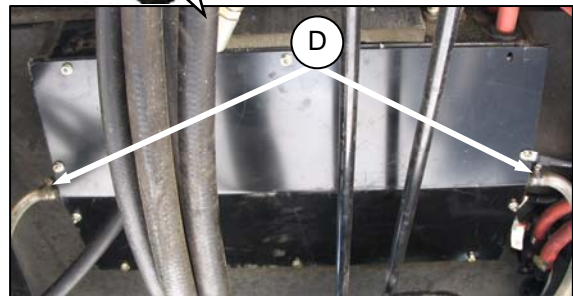

- a. Loosen the clamps (D) on the two drain hoses and pull the hoses off the air conditioning drain tubes.

(continued next page)

MAINTENANCE/SERVICE

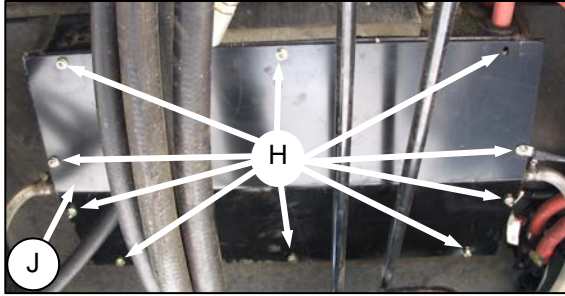

- b. Remove the ten screws (H) that attach the cover (J) and remove the cover.



WARNING

To avoid cuts from evaporator fins, do not use bare hands to brush away clogs.

- c. Use a vacuum or compressed air to remove dirt from inside the unit.

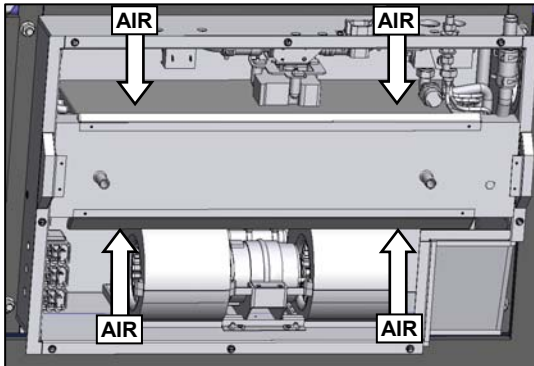

- d. Blow compressed air through the evaporator fins from the blower side first as shown. Direct the air straight into the evaporator to prevent fin damage. A nozzle extension would make this procedure easier.
- e. Repeat the previous step from the side opposite the blowers.
- f. If dirt is still present, soak evaporator in water to loosen dirt, and then blow out with compressed air.
- g. Straighten any bent fins.
- h. Reposition cover (J) and attach with eight screws (H).
- i. Reattach drain hoses to drain tubes and secure with hose clamps (G).

57.5.5.5 A/C Compressor Protection

The compressor is protected from excessively low and high pressures by two switches that shut down the compressor to prevent damage to the system. These switches do not require any regular servicing or maintenance, so if problems occur and the switches are suspect, contact your dealer.

57.5.5.6 Refrigerant and Oil

IMPORTANT

Perform the following steps whenever the machine is first started after storage for more than one week:

- a. Ensure heater shut-off valve at engine is open. See 5.10.3 Heater Shut-off Valve.

TEMPERATURE CONTROL

Controls Cab Temperature
INCREASE – Clockwise
DECREASE - Counter-Clockwise

BLOWER SWITCH

Controls Blower Speed
OFF/LO/MEDIUM/HI



AIR CONDITIONING SWITCH

Controls A/C System
OFF - A/C Does Not Operate.
ON - A/C Operates With Blower Switch On.

- b. Turn blower switch to first position, turn temperature control switch to maximum heating, and A/C control to "OFF".
- c. Start engine and operate at low idle until engine is warm.
- d. Click A/C switch from "OFF" to "ON" for one second, then back to "OFF" for 5 to 10 seconds. Repeat this step ten times.

MAINTENANCE/SERVICE

57.6 ENGINE



CAUTION

- Never operate engine in a closed building. Proper ventilation is required to avoid exhaust gas hazards.
- Keep the engine clean. Straw and chaff on a hot engine are a fire hazard.
- Never use gasoline, naphtha or any other volatile material for cleaning purposes. These materials are toxic and/or flammable.

57.6.1 General Engine Inspection

Have the overhead valve lash checked and adjusted every 5000 hours or 4 years by your Windrower dealer.

A general engine inspection, including the fuel injection pump and nozzle inspection, is recommended every 2000 hours. See your dealer.

57.6.2 Oil Level

Check engine oil level frequently and watch for any signs of leakage.

NOTE

During the break-in period, a higher than usual oil consumption should be considered normal.

- a. Stop the engine and remove the key. Wait about 5 minutes.

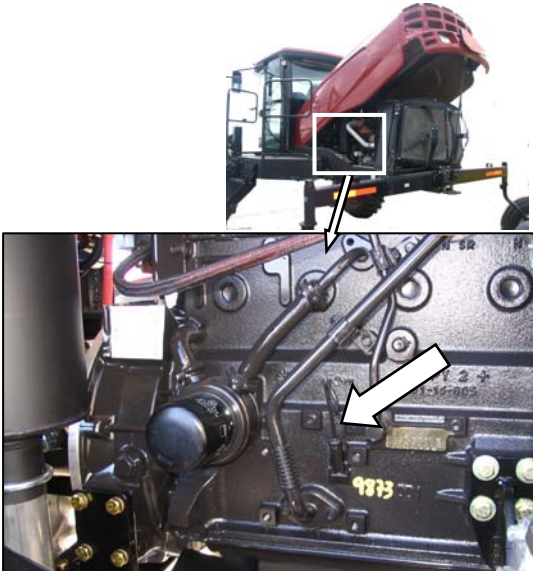

- b. Open engine compartment hood to lowest position.
- c. Remove dipstick by turning it counterclockwise to unlock and remove.
- d. Wipe clean, reinsert in engine and remove.

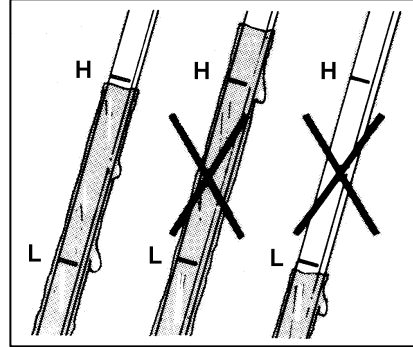

- e. Oil level should be between LOW and HIGH marks.
- f. Replace dipstick.
- g. Add oil as follows if level is below the LOW mark. One U.S. qt. (1 liter) will raise the level from LOW to HIGH:



CAUTION

Do not fill above the HIGH mark.

1. Move platform to aft position.

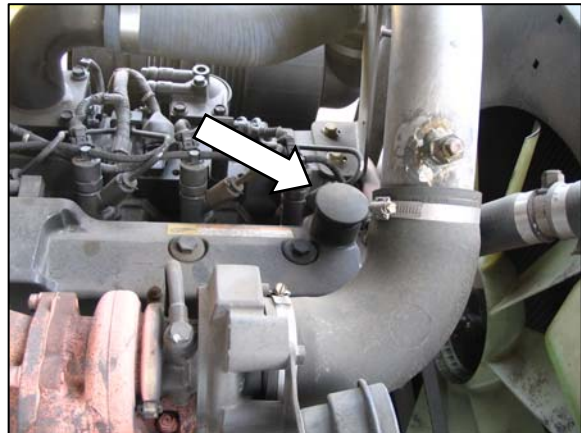

2. Remove filler cap on top of engine.
 3. Carefully pour the oil. Use SAE 15W40 Compliant With SAE Specs for API Class SJ and CH-4 Engine Oil. A funnel is recommended to avoid spillage.
 4. Replace oil filler cap.
- h. Close engine compartment hood.

MAINTENANCE/SERVICE

57.6.3 Changing Oil and Oil Filter

NOTE

The engine should be warm prior to changing the oil.

- a. Stop the engine and remove the key.
- b. Place a drain pan of about 5 U.S. gallons (20 liters) under the engine oil drain.

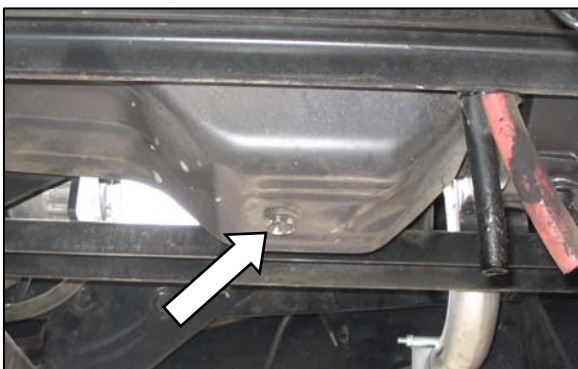

- c. Remove oil pan drain plug and allow the oil to completely finish draining.
- d. Check the condition of the used oil. If either of the following is evident, have your dealer correct the problem before starting the engine:
 1. Thin black oil indicates fuel dilution.
 2. Milky discoloration indicates coolant dilution.
- e. Open engine compartment hood to lowest position.

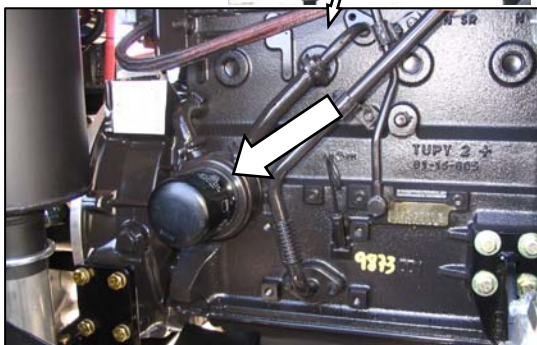

- f. Clean around the filter head.
- g. Remove filter.
- h. Clean gasket mating surface.
- i. Apply a thin film of clean oil to the gasket on the new filter.

- j. Screw the new filter onto the filter mount until the gasket contacts the filter head.
- k. Tighten the filter an additional $\frac{1}{2}$ to $\frac{3}{4}$ turn by hand.

IMPORTANT

Do not use a filter wrench to install the oil filter. Over-tightening can damage the gasket and filter.

- l. Install the oil pan drain plug.

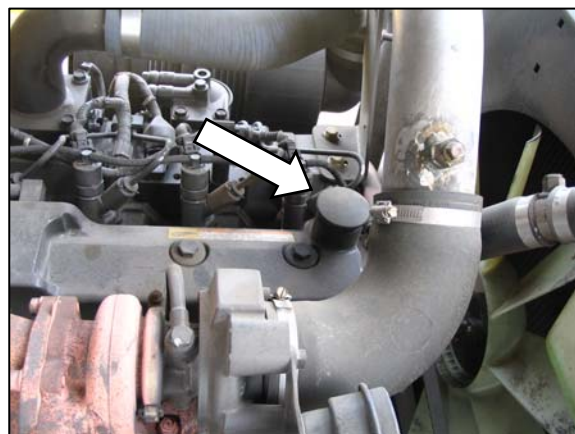

- m. Remove oil filler pipe cap and add engine oil. The engine requires 7.6 U.S. quarts (7 liters) of SAE 15W40 Compliant with SAE Specs for API Class SJ and CH-4 Engine Oil. Replace filler pipe cap.
- n. Operate the engine at low idle and check for leaks at the filter and drain plug.
- o. Stop the engine, wait 5 minutes and check the oil level. Add or remove oil to bring oil to HIGH level mark on dipstick.
- p. Close engine compartment hood.
- q. Properly dispose of used oil and filter.

MAINTENANCE/SERVICE

57.6.4 Air Intake System

IMPORTANT

Do not run engine with air cleaner disconnected or disassembled.

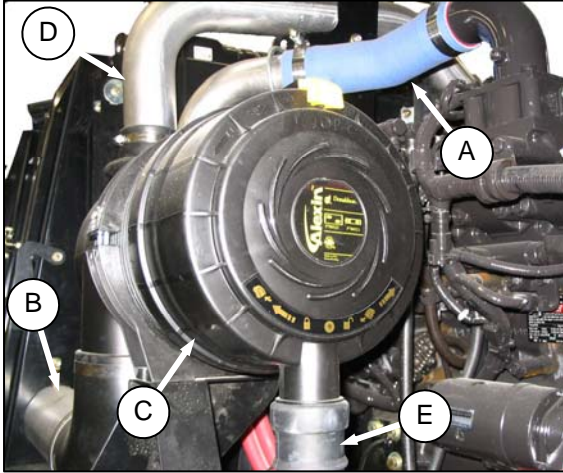

Engine intake air (A) is drawn through a duct (B) from the cooling box that pre-cleans the air, then through a dual element filter (C) to the turbocharger intake (D). The charged air then passes through a cooler and into the engine. The air cleaner canister is equipped with a vacuator valve (E) that removes dust continuously from the air cleaner housing.

57.6.4.1 Restriction Gauge

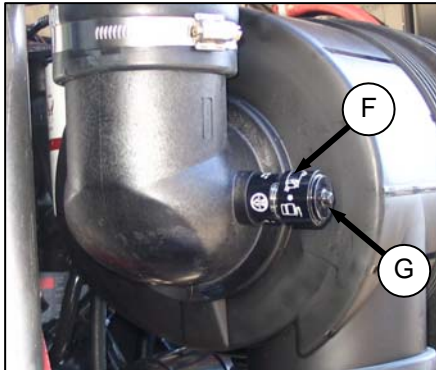

The air cleaner is also equipped with a mechanical sensor (F) which indicates red when the primary filter element requires servicing.

- Check restriction gauge daily.
- After servicing, re-set restriction gauge by pushing button (G) on top of gauge.

NOTE

Only service filter element when restriction gauge indicates red. Over-servicing the filter element increases the risk of dirt being ingested by the engine, and severely damaging the engine.

57.6.4.2 Air Filter Servicing



DANGER

Stop engine and remove key from ignition before leaving operator's seat for any reason. A child or even a pet could engage an idling machine.

- Open engine compartment hood to highest position.

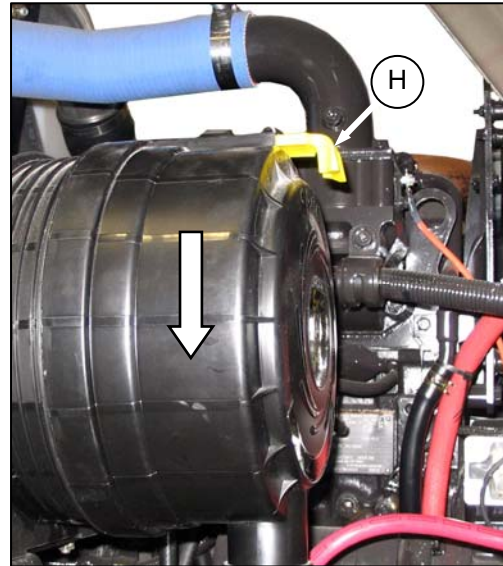

- Slide yellow locking tab (H) to release canister end cap and rotate end cap counterclockwise until it stops.
- Pull off end cap.
- Check the vacuator valve (E) daily for obstructions or damage. Clean or replace if necessary.

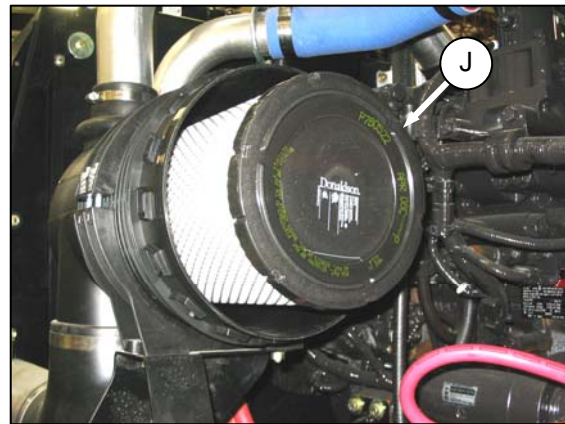

- Pull out the primary filter element (J) and inspect as follows:

(continued next page)

MAINTENANCE/SERVICE

IMPORTANT

Air filter element cleaning is not recommended due to the possible degradation of the element material. If cleaning is performed, there are several risks involved, and the following procedures should be followed:

1. Hold a bright light inside element and check carefully for holes. Discard any element which shows the slightest hole.
 2. Be sure outer screen is not dented. Vibration would quickly wear a hole in the filter.
 3. Be sure filter gasket is in good condition. If gasket is damaged or missing, replace element.
 4. If element is coated with oil or soot, replace the element.
- f. Inspect the air intake piping for damage, cracked hoses, loose clamps, etc. Repair or replace damaged parts and tighten loose clamps.

IMPORTANT

Do not remove the secondary filter element (K) unless it needs replacing. Do not attempt to clean the secondary (inner) element.

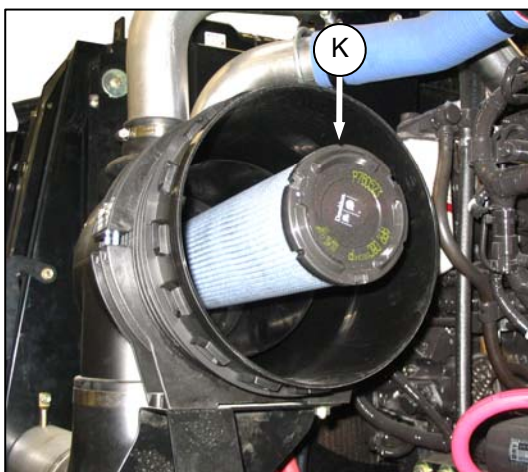

- g. Check the secondary element (K) for cleanliness. If there is visible dirt on the secondary element, replace both primary and secondary elements.

IMPORTANT

The air cleaner's primary (outer) filter element should be replaced after three cleanings or at the specified interval. Refer to Section 7.13 MAINTENANCE SCHEDULE.

IMPORTANT

The secondary (inner) element should be replaced every third time the primary element is changed.

- h. Clean inside of canister and cover with a damp cloth.

IMPORTANT

Leave secondary element in place to prevent ingress of dirt into engine intake.

- i. Pat sides of primary element gently to loosen dirt. Do not tap element against a hard surface.
- j. Using a Dry Element Cleaner Gun, clean element with compressed air.
- k. Hold nozzle next to inner surface, and move up and down pleats.

IMPORTANT

Air pressure must not exceed 60 psi (414 kPa). Do not direct air against outside of element, as dirt might be forced through to inside.

- l. Repeat steps h. and i. to remove additional dirt.
- m. Repeat inspection before installing.
- n. To remove the secondary element (K), pull it out of the canister.
- o. Insert secondary filter element into canister, seal first, and push until seal is seated inside canister.

IMPORTANT

When replacing secondary filter, reinsert new filter as soon as possible to prevent dirt entering engine intake

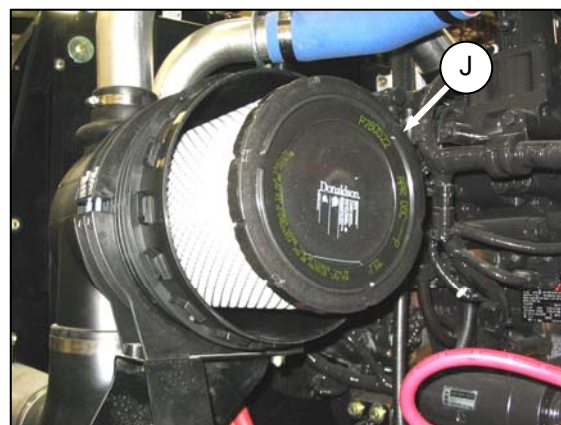

- p. Insert primary filter element (J) into canister over secondary element and push into place, ensuring that element is firmly seated in canister.

MAINTENANCE/SERVICE

- q. Position end cap onto filter housing with vacuator valve pointing approximately down.
- r. Rotate end cap clockwise until it stops.

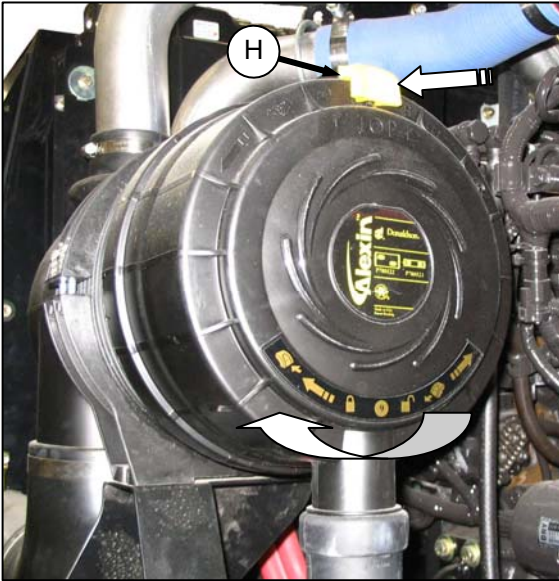

- s. Slide yellow locking tab (H) to lock end cap in place.
- t. Close engine compartment hood.

57.6.4.3 Charge Air Cooling

After the intake air passes through the air filter, it passes through the turbocharger which boosts the pressure. This process heats the air so it is passed through a cooler before entering the engine intake. The cooler is located in the cooling box behind the radiator and should be cleaned daily with compressed air. Refer to Section 7.9.2, Cooling Box Maintenance.

MAINTENANCE/SERVICE

57.6.5 Fuel System

57.6.5.1 Fuel Tank Venting

The fuel tank is vented by a hose that is connected to the filler tube. The hose is connected to a filter that should be changed annually. Change the filter as follows:



DANGER

Stop engine and remove key from ignition before leaving operator's seat for any reason. A child or even a pet could engage an idling machine.



WARNING

To avoid personal injury or death from explosion or fire, do not smoke or allow flame or sparks near windrower when servicing.

- Open engine compartment hood to highest position.

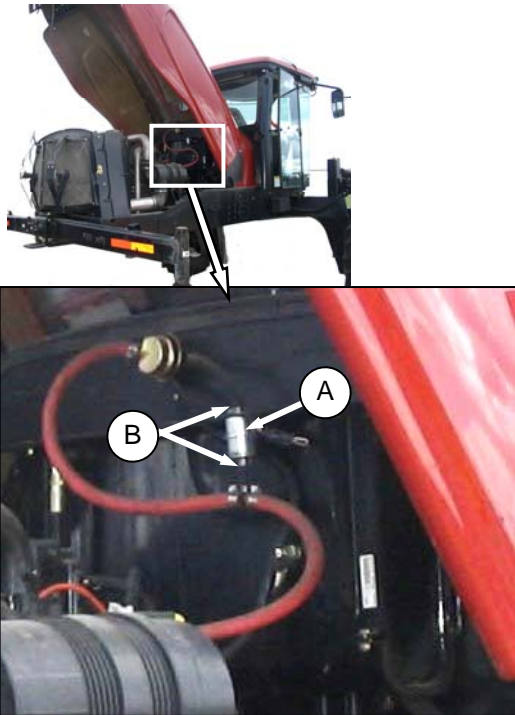

- Locate filter (A) on vent line against hydraulic oil reservoir.
- Release hose tension clamps (B) and slide away from filter. Pull hoses off filter.
- Position new filter through hole in frame and attach top hose onto filter. "IN" marking should face down.

NOTE

If filter has an arrow instead of an IN marking, arrow should point up.

- Attach lower hose to filter and secure both hoses with tension clamps (B).

MAINTENANCE/SERVICE

57.6.5.2 Fuel Filters

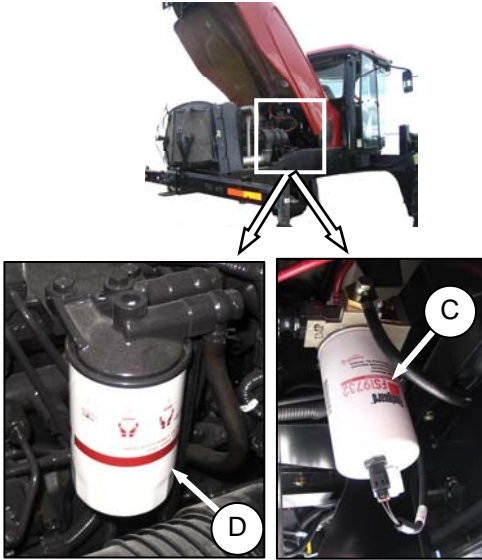

The M100 windrower fuel system is equipped with primary (C) and secondary (D) filters. Both filters are screw-on cartridge type but the primary (C) filter is equipped with a separator that separates sediment and water from the fuel. Change both filters as follows every 500 hours of operation:

- a. Open engine compartment hood to highest position.

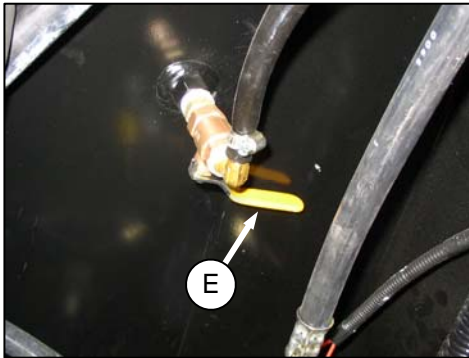

- b. Close fuel supply valve (E) under fuel tank.

- c. Change primary filter (C) as follows:



1. Clean around the filter head (F).
2. Disconnect Water in Fuel (WIF) sensor (G) from bottom of filter.
3. Remove filter (C) with a filter wrench.
4. Clean gasket mating surface.
5. Fill new filter with clean fuel and apply a thin film of clean oil to the gasket on the new filter.
6. Screw the new filter (C) onto the filter mount until the gasket contacts the filter head.
7. Reconnect WIF sensor (G).
8. Tighten the filter an additional $\frac{1}{2}$ to $\frac{3}{4}$ turn by hand.

IMPORTANT

Do not use a filter wrench to install the filter. Over-tightening can damage the gasket and filter.

(continued next page)

MAINTENANCE/SERVICE

- d. Change secondary filter (D) as follows:

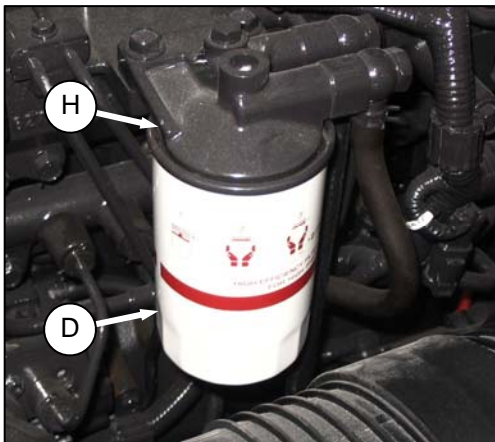

1. Clean around the filter head (H).
2. Remove filter (D) with a filter wrench.
3. Clean gasket mating surface.
4. Apply a thin film of clean oil to the gasket on the new filter.
5. Screw the new filter onto the filter mount until the gasket contacts the filter head.
6. Tighten the filter an additional $\frac{1}{2}$ to $\frac{3}{4}$ turn by hand.

IMPORTANT

Do not use a filter wrench to install the filter. Over-tightening can damage the gasket and filter.

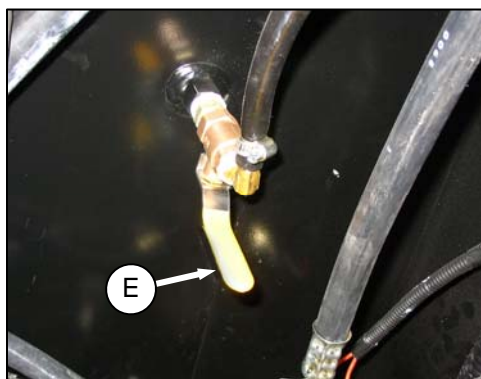

- e. Open fuel valve (E) under fuel tank.
- f. Use priming pump on primary filter to fill new filter.
- g. Close engine compartment hood.

57.6.5.3 Draining Fuel Tank

Draining the fuel tank is necessary to remove old or contaminated fuel. To drain the tank refer to following illustrations and proceed as follows:

- a. Stop the engine and remove the key.
- b. Open engine compartment hood to lowest position.

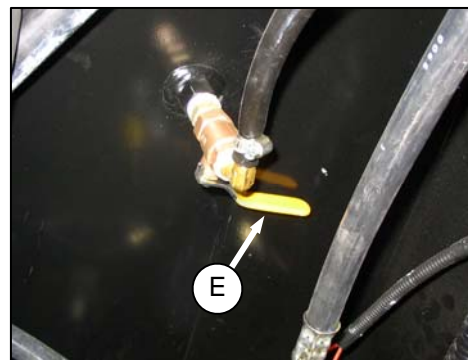

- c. Close fuel supply valve (E).
- d. Place a drain pan of about 5 U.S. gallons (20 liters) under the fuel supply line (J).

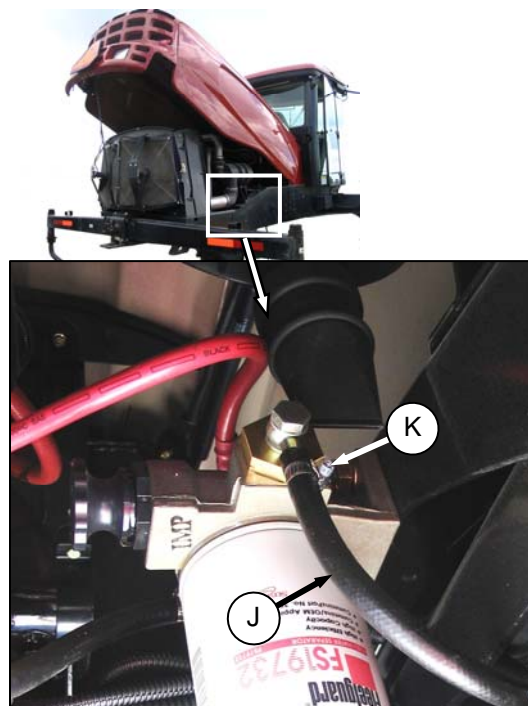

- e. Loosen clamp (K) and pull hose (J) off fitting.
- f. Route hose to drain pan and open valve (E) to drain tank.

(continued next page)

MAINTENANCE/SERVICE

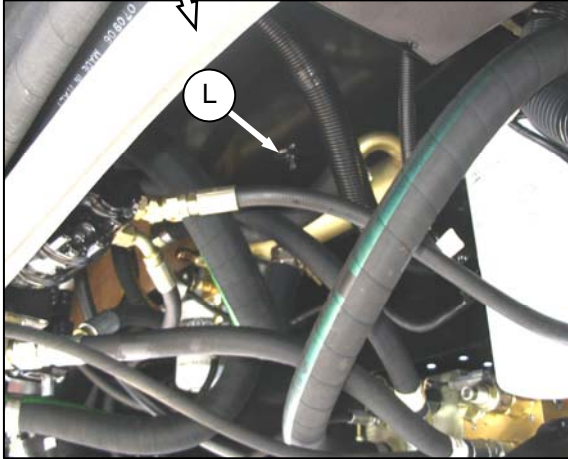

- g. Remove plug (L) to ensure tank is completely drained after fuel has stopped flowing from hose.
- h. Add some clean fuel to tank to flush out any remaining contaminants.

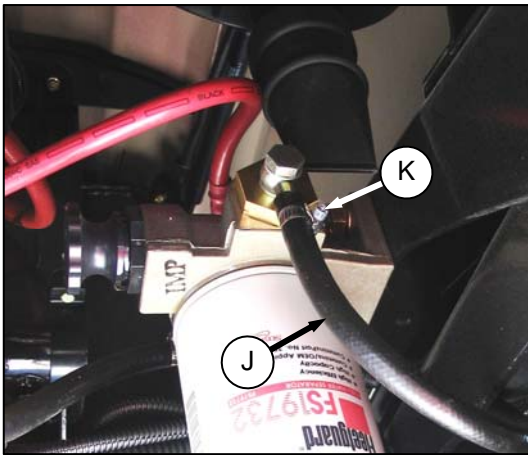

- i. Replace drain plug and reattach hose (J) to fitting. Install clamp (K) and tighten.
- j. Refill tank.

57.6.5.4 Separator

A fuel water separator is incorporated into the primary fuel filter. The separator is equipped with a sensor (G) that detects water in the fuel and alerts the operator on the CDM. Drain the water and sediment as follows from the separator daily or at any time the CDM Water in Fuel (WIF) light illuminates.

- a. Stop engine and remove key.

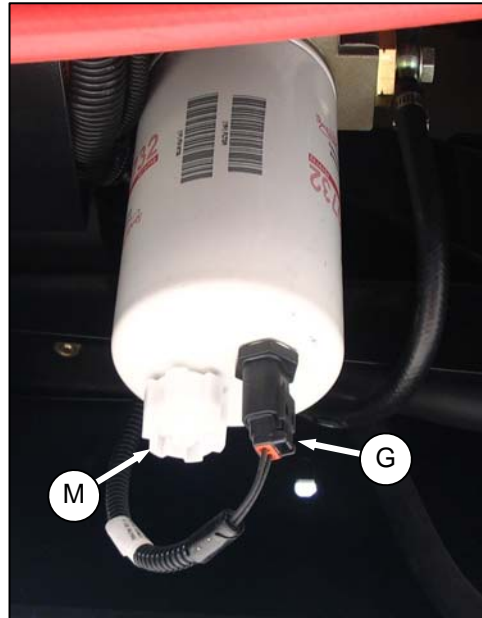

- b. Turn drain valve (M) by hand 1½ to 2 turns counterclockwise until draining occurs.
- c. Drain the filter sump of water and sediment until clear fuel is visible.
- d. Turn the valve clockwise to close the drain.

MAINTENANCE/SERVICE

57.6.5.5 System Priming

Controlled venting of air is provided at the injection pump through the fuel drain manifold. Small amounts of air introduced by changing filters or injection pump supply line will be vented automatically, if the fuel filters are changed in accordance with instructions.



WARNING

The fuel pump high-pressure fuel lines and fuel rail contain extremely high pressure fuel. Never loosen any fittings. Personal injury and property damage can result.

IMPORTANT

Bleeding the fuel system is not recommended nor required.

- a. Manual priming may be required if:
 - The fuel filter is not filled prior to installation.
 - Injection pump is replaced.
 - High-pressure fuel lines are replaced.
 - Engine is run until fuel tank is empty.
- b. Prime the fuel system as follows:
 1. Stop the engine and remove the key.
 2. Open engine compartment hood to lowest position.



3. Turn the priming knob (A) counterclockwise to unlock the plunger on the primary filter head.

4. Pump approximately 120 times to pressurize the fuel system.
5. Lock the plunger by turning knob (A) clockwise until snug.

MAINTENANCE/SERVICE

57.6.6 Engine Cooling System

The engine cooling system is designed to maintain the engine operating temperature within the specified operating range.

NOTE

Anti-freeze is essential in any climate. It broadens the operating temperature range by lowering the coolant freezing point and by raising its boiling point. Anti-freeze also contains rust inhibitors and other additives to prolong engine life.

IMPORTANT

If anti-freeze strength is not adequate, do not drain cooling system to protect against freezing. System may not drain completely, and damage from freezing could still result.

To service the cooling system, perform the following:



DANGER

Stop engine and remove key from ignition before leaving operator's seat for any reason. A child or even a pet could engage an idling machine.

- Stop engine and remove key.
- Move the maintenance platform to the open position for access to the coolant tank and radiator. Ensure the platform latch is engaged in open position.



- Raise engine compartment hood to lowest position.

57.6.6.1 Coolant Level and Concentration

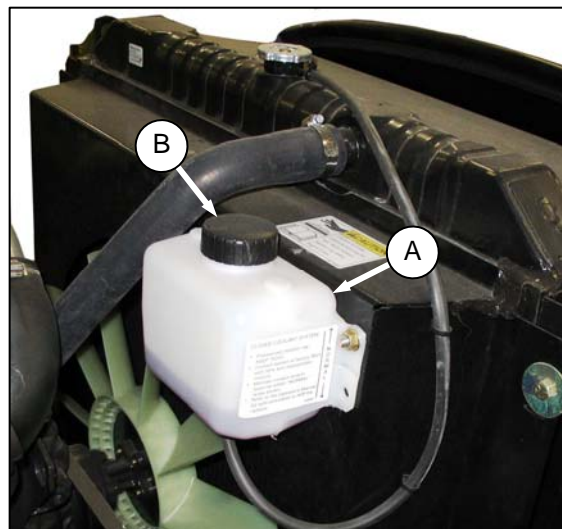

- Check daily the coolant level in the coolant recovery tank (A). Tank should be at least half full.
- If less, then remove cap (B) and add coolant. Use Ethylene Glycol with SCA and equal parts of high quality, soft, de-ionized, or distilled water as recommended by the supplier to protect the engine to temperatures of -30°F (-34°C).

NOTE

Do not add coolant to radiator except when changing coolant.

- Replace cap (B).

MAINTENANCE/SERVICE

57.6.6.2 Radiator Cap



CAUTION

To avoid personal injury from hot coolant, do not turn radiator cap until engine has cooled.

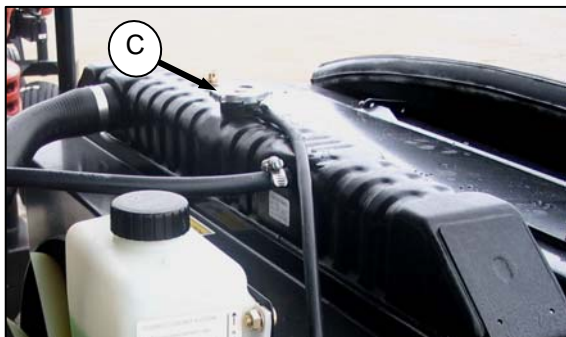

- a. Remove the radiator cap (C) and check as follows:

1. The radiator cap must fit tightly.

NOTE

Cap gasket must be in good condition to maintain the 14-18 psi (97-124 kPa) pressure in the cooling system. To check the cap, proceed as follows:

2. Turn the cap counterclockwise to the first notch to relieve pressure before removing cap completely.
 3. Turn the cap again and remove.
 4. Check the gasket for cracks or deterioration and replace the cap if necessary.
 5. Check that the spring in the cap moves freely.
 6. Check the anti-freeze in the radiator with a tester annually, preferably before off-season storage. Tester should indicate protection to temperatures of -30°F (-34°C).
- b. Replace the cap if spring is stuck.
 - c. Close engine compartment hood and move maintenance platform to working position.

57.6.6.3 Changing Coolant

Coolant should be drained, and the system flushed and filled with new coolant every 2000 hours or 2 years. Change coolant, and flush the system as follows:



CAUTION

To avoid personal injury from hot coolant, do not turn radiator cap until engine cools.



DANGER

Stop engine and remove key from ignition before leaving operator's seat for any reason. A child or even a pet could engage an idling machine.

- a. Stop engine and let it cool.
- b. Move the maintenance platform toward the rear of the windrower. Ensure the lock is engaged.
- c. Raise engine compartment hood to lowest position.

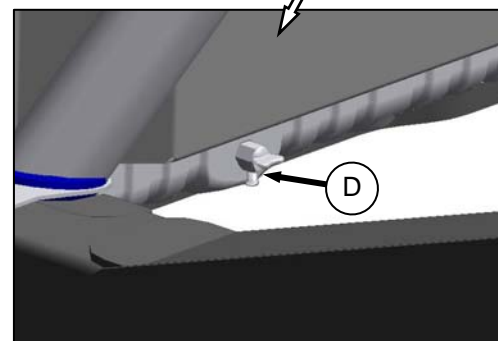

- d. Turn the radiator cap (C) to the first notch to relieve pressure before removing cap completely.
- e. Place a drain pan (about 8 U.S. gallons (30 liters)) under the engine and radiator.
- f. Remove the radiator cap and open radiator drain valve (D) on the engine side of the radiator lower tank. Use a deflector or a hose to prevent coolant running onto frame.

(continued next page)

MAINTENANCE/SERVICE

- g. Loosen drain plug in engine block so that coolant drains.
- h. When system is drained, replace drain plug in block and close radiator drain valve (D).
- i. Fill system with clean water through the radiator and replace radiator cap.

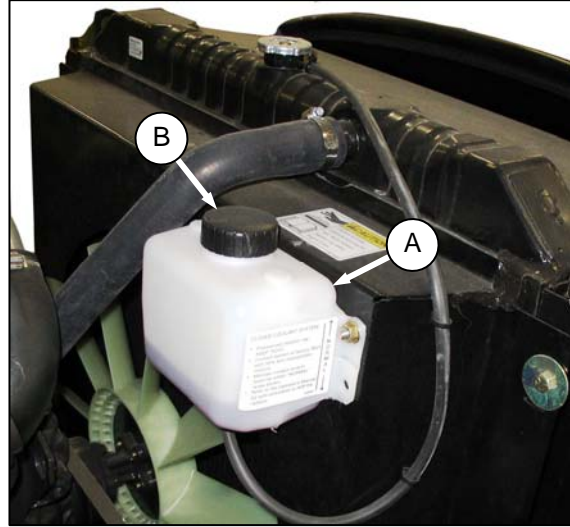
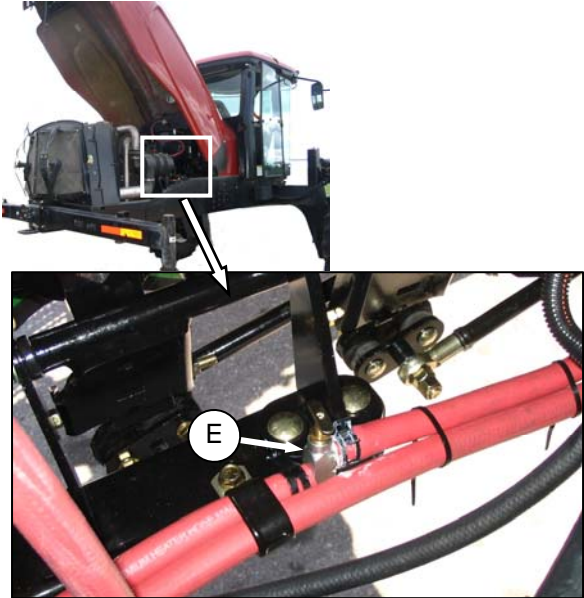

- q. Remove cap (B) from recovery tank (A) and add coolant until half full.
- r. Move maintenance platform to working position and close engine compartment hood.

- j. Open heater shut-off valve (E).
- k. Start engine and turn temperature control knob to high. Run engine until normal operating temperature is reached.
- l. Stop engine and drain water out before rust or sediment settles. See steps d. to g.
- m. Close drain valves and fill system with a solution of clean water and a heavy duty radiator cleaner. Follow instructions provided with cleaner.
- n. After using cleaner solution, again flush system with clean water. Inspect radiator, hoses and fittings for leaks.
- o. Close drain valves and fill system through radiator with an equal part mix of anti-freeze and clean, soft water. Use Ethylene Glycol with SCA and equal parts of high quality, soft, de-ionized, or distilled water as recommended by the supplier to protect the engine to temperatures of -30°F (-34°C). System capacity is 5.3 U.S. Gallons (20 liters).
- p. Close radiator cap tightly.

MAINTENANCE/SERVICE

57.6.7 Exhaust System



CAUTION

To avoid burns, do not touch muffler when engine is running or before allowing sufficient cooling time after shut-down

The exhaust system requires no regular maintenance but it should be inspected periodically as follows:

- a. Open engine compartment hood to highest position.

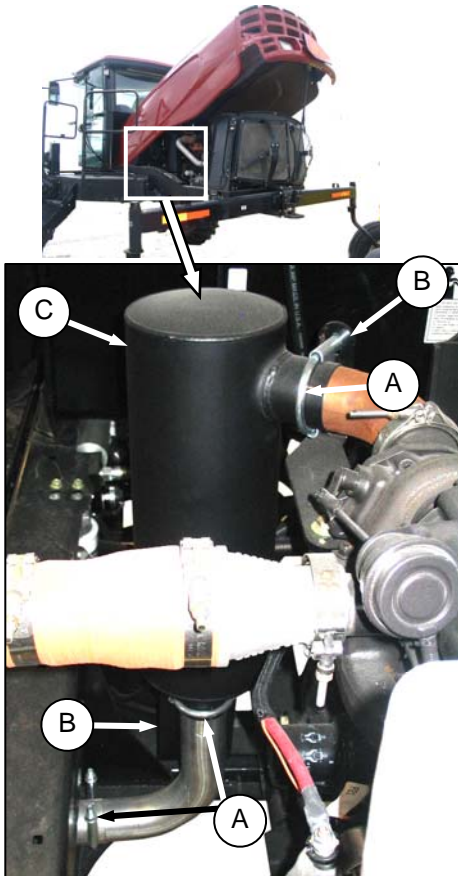

- b. Inspect the area around clamps (A) for breakage, cracks and rust-through. In addition to excess noise, a leaky exhaust system may allow exhaust gases to escape to the cab.
- c. Dents or crushed portions of any tubing create exhaust flow restriction and increase back pressure significantly. Even relatively small dents will cause decreased fuel economy and increased turbo wear. If dents are relatively large, increased bearing and cylinder wear will occur due to increased exhaust temperature.

- d. The exhaust system should be secured to eliminate vibration. The brackets (B) should fit securely to the muffler (C) and to the engine.
- e. Do not change muffler type, piping sizes or exhaust configuration; these have all been selected for some very specific, technical reasons by the engineer. See your dealer for proper replacement parts.

MAINTENANCE/SERVICE

57.6.8 Belts



DANGER

Stop engine and remove key from ignition before leaving operator's seat for any reason. A child or even a pet could engage an idling machine.

57.6.8.1 Fan Belt Tension

- a. Shutdown engine and open engine compartment access hood to lowest position.

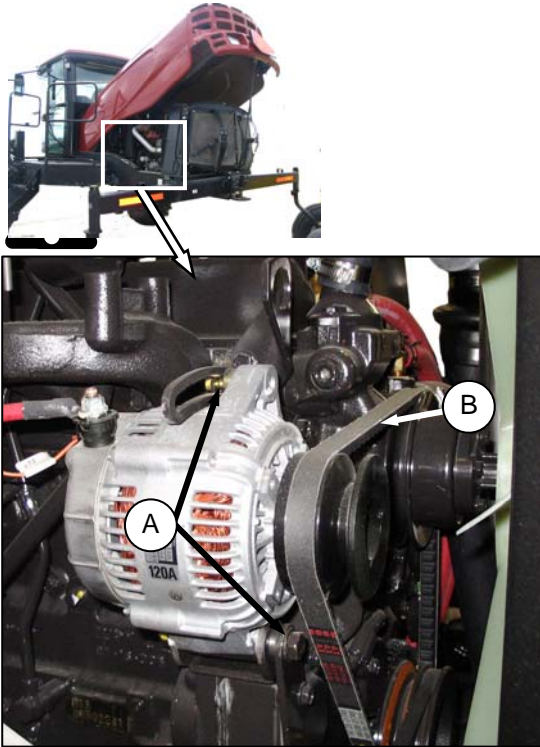

- b. Loosen alternator mounting hardware (A).
- c. Pry alternator away from engine so that a force of 22 lbf (100 N) deflects belt (B) 5/16 to 1/2 inch (8 to 12 mm) at mid-span between fan pulley and alternator.



CAUTION

Overtightening the belt will result in alternator damage.

- d. Tighten alternator mounting hardware (A).
- e. Recheck tension and re-adjust as required.

57.6.8.2 Fan Belt Replacement



DANGER

Stop engine and remove key from ignition before leaving operator's seat for any reason. A child or even a pet could engage an idling machine.

- a. Shutdown the engine and open engine compartment access hood to highest position.

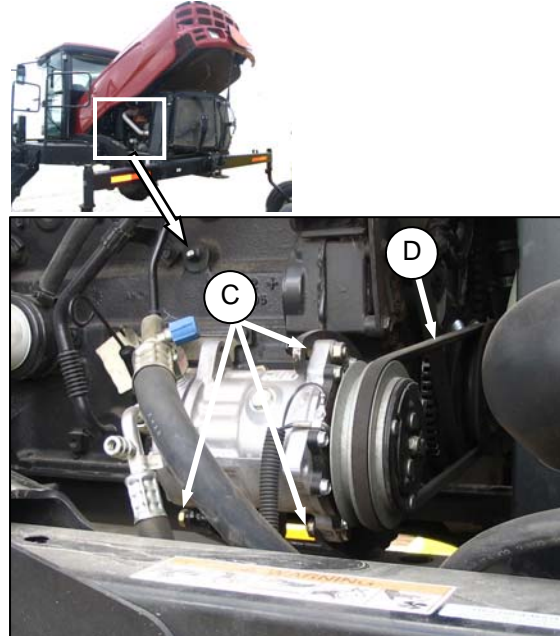

- b. Loosen compressor mounting hardware (C) and push compressor towards engine to release belt (D) tension.
- c. Remove belt (D).
- d. Loosen alternator mounting hardware (A) and push alternator towards engine to release belt (B) tension.
- e. Remove belt (B).
- f. Install new belt (B) on pulleys.
- g. Pry alternator away from engine so that a force of 22 lbf (100 N) deflects belt (B) 5/16 to 1/2 inch (8 to 12 mm) at mid-span between fan pulley and compressor.
- h. Tighten alternator mounting hardware (A).
- i. Recheck tension and re-adjust as required.
- j. Install A/C compressor belt (D) on pulleys.
- k. Pry compressor away from engine so that a force of 8 to 12 lbf (35-55 N) deflects the belt (D) 3/16 inch (5 mm) at mid-span.
- l. Tighten compressor mounting hardware (C).
- m. Recheck tension and re-adjust as required.
- n. Close engine compartment hood.

MAINTENANCE/SERVICE

57.6.8.3 A/C Compressor Belt Tension

- a. Shutdown engine and open engine compartment access hood to lowest position.

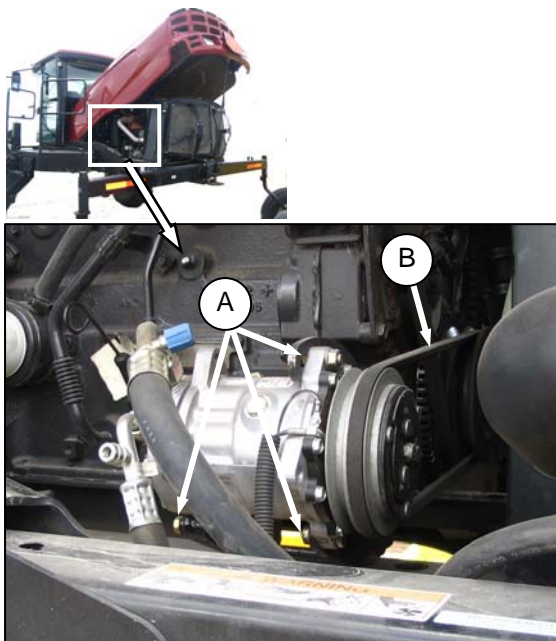

- b. Loosen compressor mounting hardware (A).
- c. Pry compressor away from engine so that a force of 8 to 12 lbf (35-55 N) deflects the belt (B) 3/16 inch (5 mm) at mid-span.
- d. Tighten compressor mounting hardware (A).
- e. Recheck tension and re-adjust as required.
- f. Close engine compartment hood.

57.6.8.4 A/C Compressor Belt Replacement

- a. Shutdown the engine and open engine compartment access hood to lowest level.
- b. Loosen compressor mounting hardware (A) and push compressor towards engine to release tension.
- c. Remove belt (B).
- d. Install new belt (B) on pulleys.
- e. Pry compressor away from engine so that a force of 8 to 12 lbf (35-55 N) deflects the belt (B) 3/16 inch (5 mm) at mid-span.
- f. Tighten compressor mounting hardware (A).
- g. Recheck tension and re-adjust as required.
- h. Re-adjust tension of a new belt after a short run-in period (about 5 hours).

57.6.9 Engine Speed

The maximum and idle engine speeds are determined by the ECM software, and factory set. See Section 4 Specifications. If specified speeds cannot be maintained, see your Windrower dealer.

57.6.9.1 Intermediate Engine Speeds

The engine operating speed can be programmed to enable the windrower to operate at reduced engine rpm without significantly affecting the ground or header speeds. Intermediate Speed Control (ISC) is useful in where operating loads are reduced such as in light crop conditions which do not require the maximum engine rpm. Reduced engine speed lowers fuel consumption, noise levels, and exhaust emissions in addition to reducing engine wear.

ISC Off (Normal) – 2600 rpm.

ISC On (Intermediate) – 2400 rpm.

Programming instructions are given in Section 5.18.5 Cab Display Monitor (CDM) Programming. The programmed engine speed is activated when the header is engaged.

57.6.9.2 Throttle Adjustment

The engine speed is controlled with the throttle lever that is connected to an electronic sensor inside the console. The throttle lever in the cab should move the throttle sensor the full range between slow speed stop and full RPM stop without contacting the console at either position. If the throttle lever is contacting the console and interferes with specified engine speeds, the sensor position possibly requires adjustment. See your Windrower dealer.

MAINTENANCE/SERVICE

57.7 COOLING BOX

57.7.1 Cooling Box Screen Cleaners

The cooling box screen is equipped with an automatic cleaning device which "vacuums" the screen by means of two rotors. They only operate when the key is on. The rotors are electrically driven and the suction is provided by the engine cooling fan.

If the screen is not being cleaned by the rotors, they may be plugged. Service rotors and screen as follows:

- a. Stop engine and remove key.
- b. Raise engine compartment hood fully.

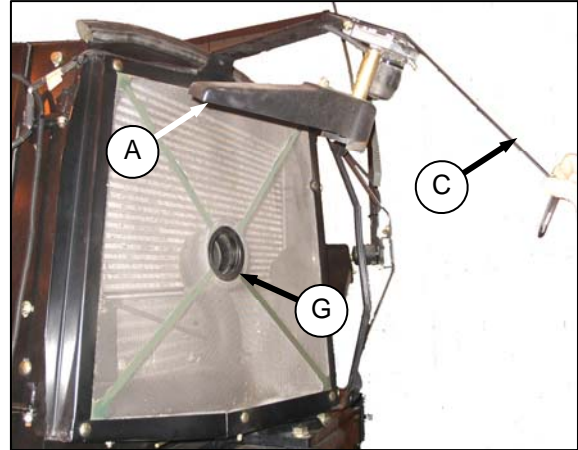
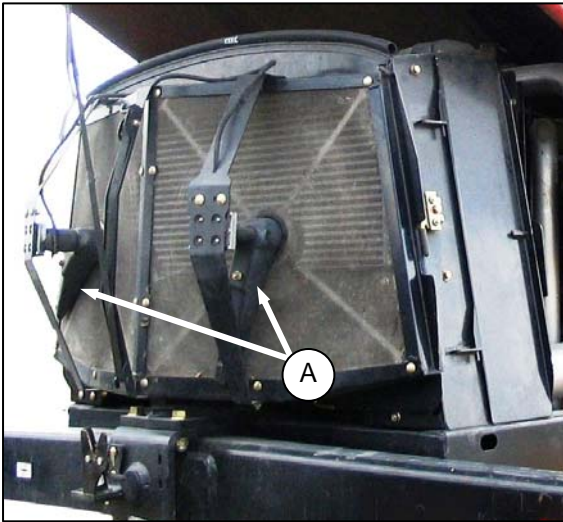

2. Pivot rotor assembly (C) away from screen.
3. Blow out debris from rotors (A) with compressed air.

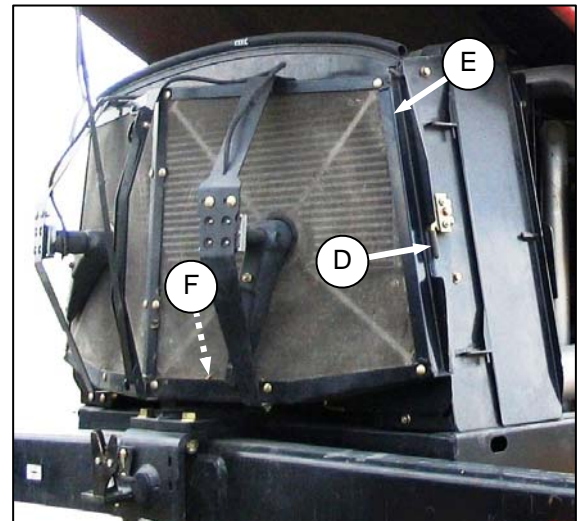

- c. If rotors (A) are plugged, clean as follows:
 1. Remove nut (B).

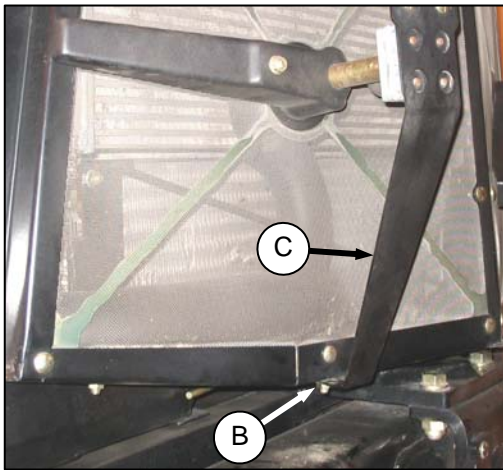

- d. Push latch (D) and open screen assembly access door (E). Secure with rod (F) stored inside screen door.
- e. If duct (G) is plugged, blow out debris with compressed air.
- f. Clean screen with compressed air.
- g. Reposition rotor assembly (C) secure with bolt and nut (B).
- h. Check clearance between trailing edge of cleaner ducts (A). It should be .04-.32 inches (1-8 mm) at all locations when rotating.

NOTE

Cleaner duct may touch screen as long as duct continues to rotate.

(continued next page)

MAINTENANCE/SERVICE

- i. If necessary, adjust clearance as follows:

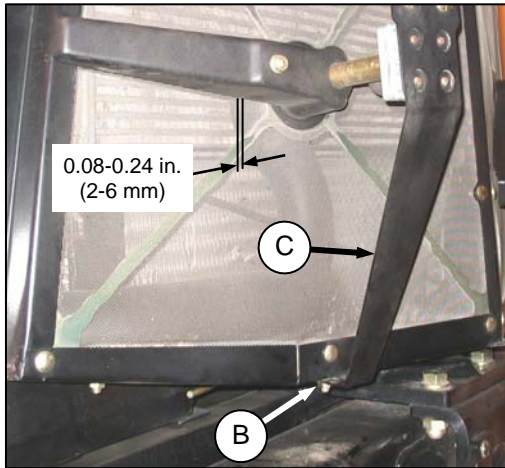

1. Loosen nut (B) on motor support (C).
2. Move support in or out until duct is 0.08-0.24 in. (2-6 mm) from screen near the center.
3. Re-tighten nut (B).

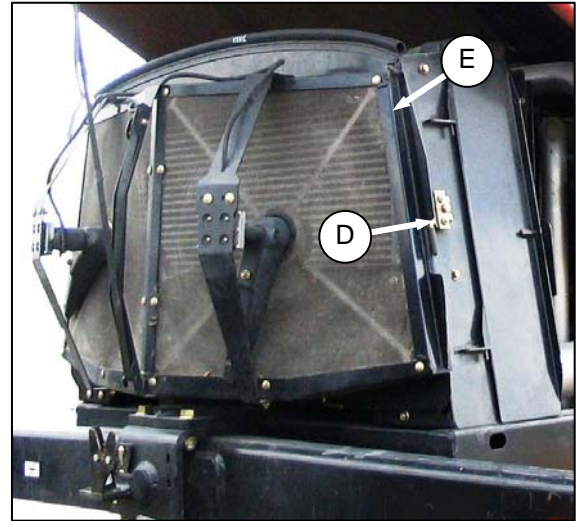

- j. Close screen access door (E) and engage latch (D).
- k. Lower engine compartment hood.

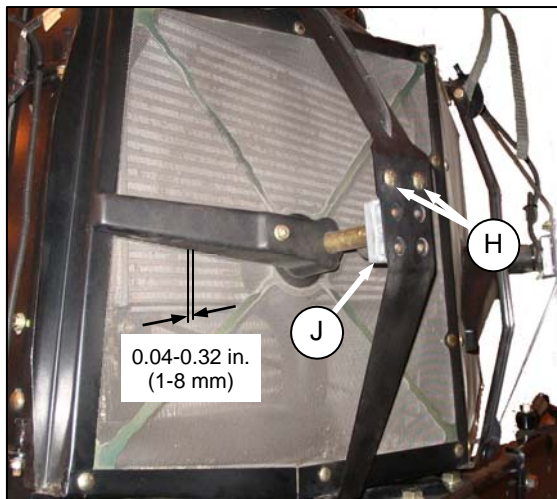

4. Loosen the two motor mount bolts (H).
5. Move motor/ duct assembly (J) to obtain 0.04-0.32 in. (1-8 mm) gap to screen at full rotation of the duct.
6. Re-tighten nuts (H) on motor mount.

MAINTENANCE/SERVICE

57.7.2 Cooling Box Maintenance

The radiator and oil cooler should be cleaned daily with compressed air and more frequent cleaning may be necessary in severe conditions. The charge air cooler and air conditioning condenser may also be cleaned at the same time. To clean these components, refer to illustrations below and proceed as follows:



DANGER

Stop engine and remove key from ignition before leaving operator's seat for any reason. A child or even a pet could engage an idling machine.

- a. Stop engine and remove key.
- b. Raise engine compartment hood fully.

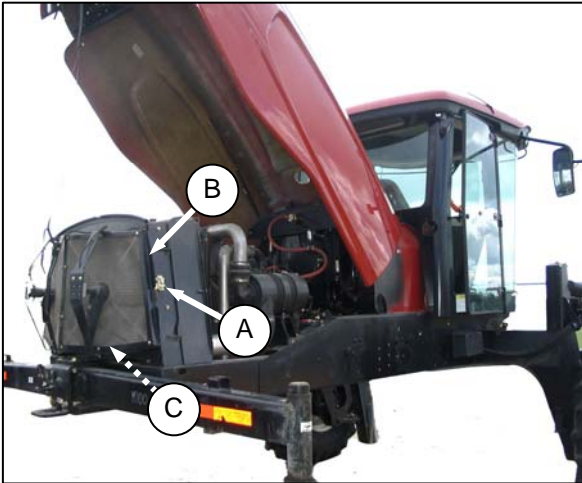

- c. Push latch (A) and open screen assembly access door (B). Secure with rod (C) stored inside the screen door.

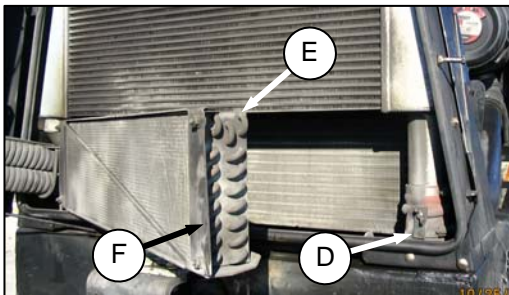

- d. Rotate retainer (D), pull open condenser (E), and secure with support rod at (F).

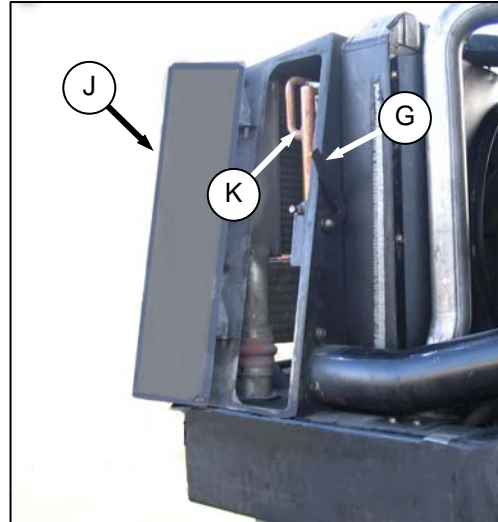

- e. Lift lever (G) and pull open access door (J).

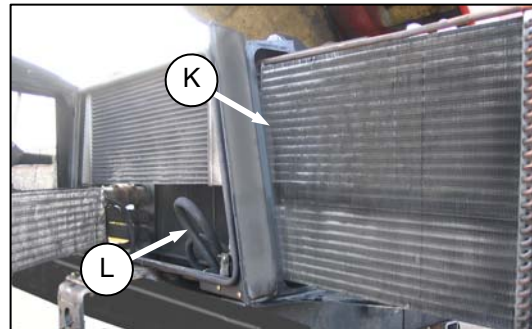

- f. Slide out the oil cooler assembly (K) with handle. If movement is restricted by hose (L), lift up on hose so that it moves away from frame.

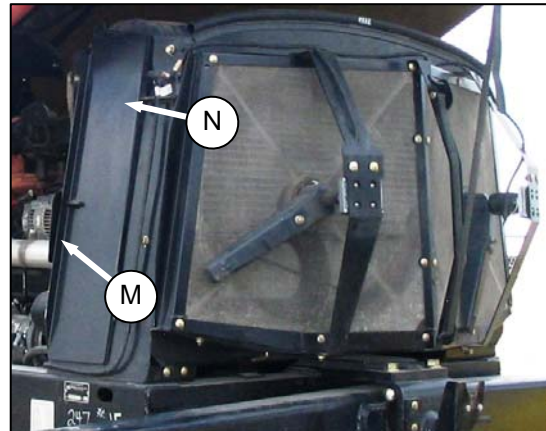

- g. Lift latch (M) and open access door (N) on the cooling box.

IMPORTANT

Fins on coolers can be very easily bent which may interfere with its function. Exercise caution when cleaning.

(continued next page)

MAINTENANCE/SERVICE

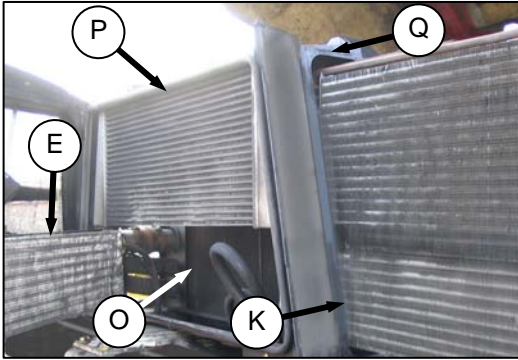

- h. Clean radiator (O), oil cooler (K), charge air cooler (P), air conditioning condenser (E) and cooling box (Q) with compressed air.

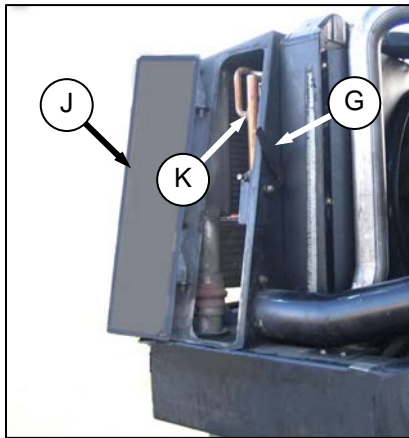

- i. Slide oil cooler (K) back into cooling box.
j. Close side access door (J) and lock with lever (G).

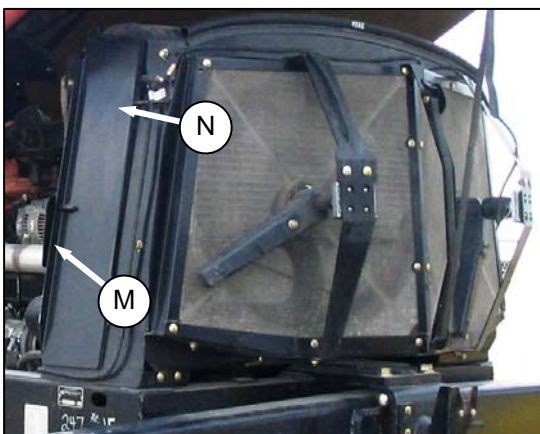

- k. Close side door (N) and secure with latch (M).

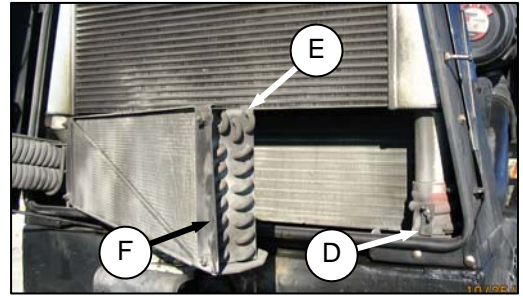

- l. Remove support rod at (F), swing condenser (E) back into position and secure with retainer (D).

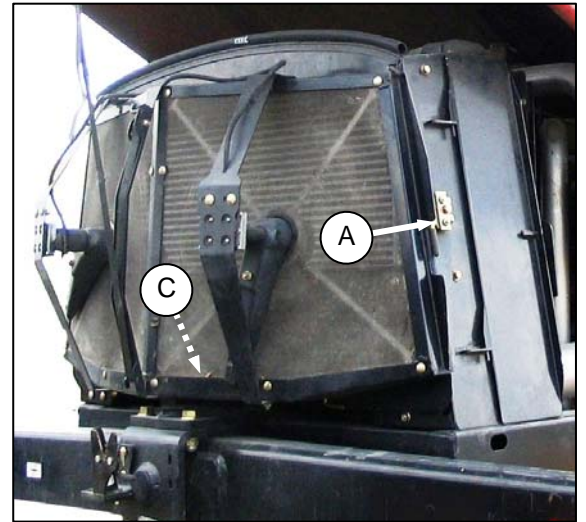

- m. Unhook support rod (C) in screen door and store at base of cooling box.
n. Close door until latch engages pin (A).
o. Lower hood and hood latch will lock hood.

MAINTENANCE/SERVICE

57.8 ELECTRICAL SYSTEM

Electrical schematics are attached at the back of this manual.

57.8.1 Battery



WARNING

- Gas given off by battery electrolyte is explosive. Keep all smoking materials, sparks and flames away from batteries.
- Follow proper charging and boosting procedures given in this section.

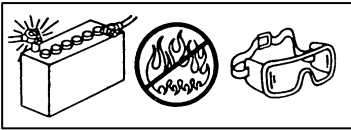

- Ventilate when charging in enclosed space.
- Always wear protective eye-wear when working near batteries.
- Do not tip batteries more than 45° to avoid electrolyte loss.
- Battery electrolyte causes severe burns. Avoid contact with skin, eyes or clothing.
- Keep batteries out of reach of children.
- If electrolyte is spilled or splashed on clothing or the body, neutralize it immediately with a solution of baking soda and water, then rinse with clean water.
- Electrolyte splashed into the eyes is extremely dangerous. Should this occur, force the eye open and flood with cool, clean water for five minutes. Call a doctor immediately.
- To avoid shocks, burns or damage to electrical system, disconnect battery ground cable before working in an area where you might accidentally contact electrical components.
- Do not operate the engine with alternator or battery disconnected. With battery cables disconnected and engine running, a high voltage can be built up if terminals touch the frame. Anyone touching the

frame under these conditions would be severely shocked.

- When working around storage batteries, remember that all of the exposed metal parts are "live". Never lay a metal object across the terminals because a spark or short circuit will result.

57.8.1.1 Maintenance



CAUTION

Do not attempt to service battery unless you have the proper equipment and experience to perform the job. Have it done by a qualified dealer

- a. Check battery charge once a year, more often if operating in cold weather. Hydrometer readings should be 1.260 to 1.300. Readings below 1.250 indicate charging is required. See Section 7.10.1.2 Charging. Add electrolyte if necessary. See Section 7.10.1.4 Adding Electrolyte.
- b. Keep battery clean by wiping it with a damp cloth.
- c. Keep all connections clean and tight. Remove any corrosion and wash terminals with a solution of baking soda and water. A light coating of grease on terminals (after cables are attached) will reduce corrosion.
- d. To prolong battery life, store batteries fully charged and at +20° to +80°F (-7° to +26°C). Check voltage after storage and recharge as needed, according to battery and charger manufacturer recommendations.
- e. Do not stack batteries on top of each other.

MAINTENANCE/SERVICE

57.8.1.2 Charging



CAUTION

- Ventilate the area where batteries are being charged.
- Do not charge a frozen battery. Warm to 60°F (16°C) before charging.
- Do not connect or disconnect live circuits. To prevent sparks, turn off charger and connect positive cable first. If charging battery in windrower, disconnect positive battery cable before connecting charger cable, then connect ground cable last, away from battery.
- Stop or cut back charging rate if battery feels hot, or is venting electrolyte. Battery temperature must not exceed 125°F (52°C).

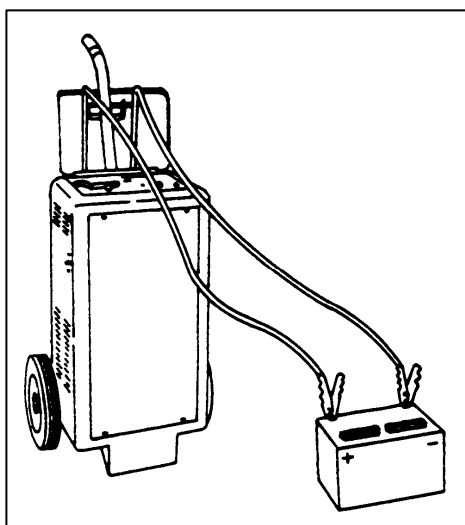

- Follow all instructions and precautions furnished by the battery charger manufacturer. Charge at recommended rates and times.

57.8.1.3 Boosting

A twelve volt battery can be connected in parallel (+ to +) with the windrower battery. Use heavy duty battery cables.



CAUTION

- Gas given off by batteries is explosive. Keep sparks and flames away from batteries.
- Make last connection and first disconnection at a point furthest away from the batteries.
- Wear protective eye-wear when using a booster battery.
- Be sure everyone is clear of machine when starting engine. Start engine from operator's station only.

- a. Open engine compartment hood.

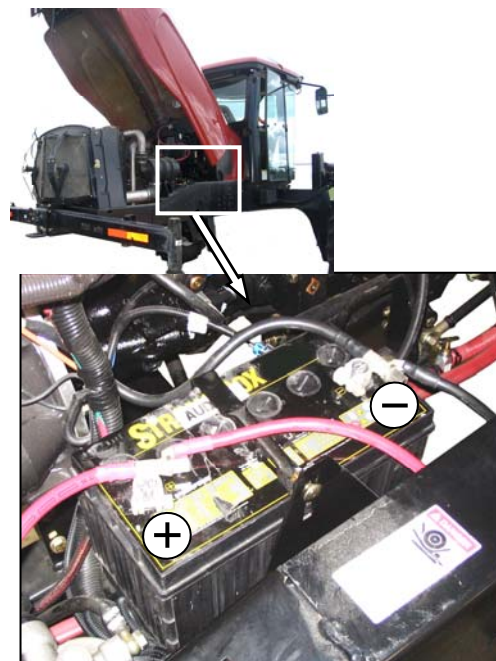

- b. Remove red rubber cover (if attached) from windrower battery positive terminal.

(continued next page)

MAINTENANCE/SERVICE

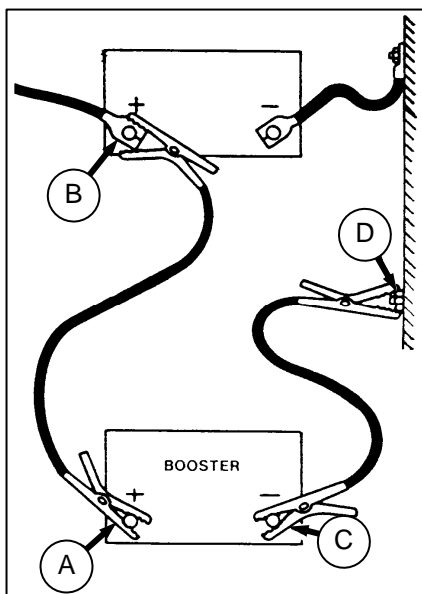

- Attach one end of battery cable to positive terminal (A) of booster battery and other end to positive terminal (B) of windrower batteries.
- Attach second cable to negative terminal (C) of booster battery and then to a good ground (D) on windrower frame.
- Turn ignition switch in cab as with normal start up.
- After engine starts, disconnect cable from windrower ground first, and then disconnect the other cables.
- Close hood.

57.8.1.4 Adding Electrolyte



WARNING

- Keep all smoking materials, sparks and flames away from electrolyte container and battery, as gas given off by electrolyte is explosive.

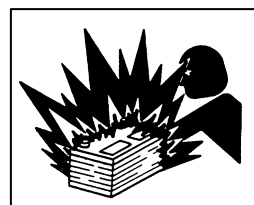

- Battery electrolyte causes severe burns. Avoid contact with skin, eyes or clothing. Wear protective eyewear and heavy gloves.

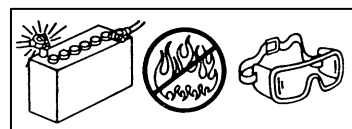

WARNING

If electrolyte is spilled or splashed on clothing or on the body, neutralize it immediately with a solution of baking soda and water, then rinse with clean water. Electrolyte splashed into the eyes is extremely dangerous. Should this occur, force the eye open and flood with cool, clean water for five minutes. Call a doctor immediately.

- If battery is installed in windrower, shutdown the engine and remove the key.
- Open engine compartment hood to highest position.



- Add electrolyte in accordance with the battery manufacturer's instructions.

MAINTENANCE/SERVICE

57.8.1.5 Replacing Battery



CAUTION

Do not attempt to service battery unless you have the proper equipment and experience to perform the job. Have it done by a qualified dealer



DANGER

Stop engine and remove key from ignition before leaving operator's seat for any reason. A child or even a pet could engage an idling machine.

- a. Stop engine and remove key.
- b. Open engine compartment hood.

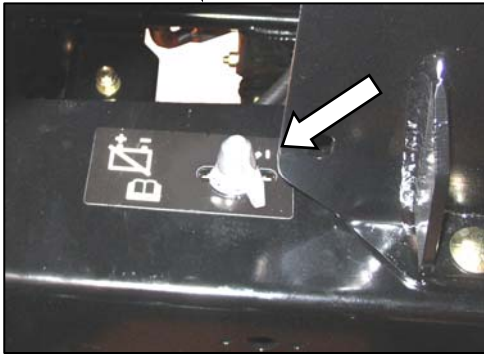

- c. Switch the battery disconnect switch to OFF.

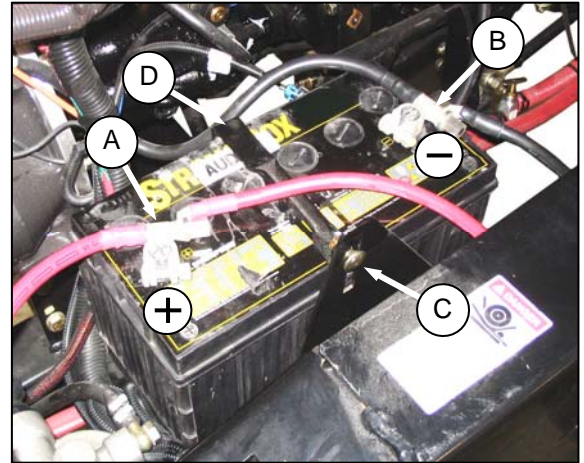

- d. Remove red plastic cover (if attached) from positive cable clamp (A). Loosen the clamp and remove cable from battery.
- e. Loosen clamp (B) on negative terminal and remove cable from battery.
- f. Remove bolt (C) securing strap (D) to frame, and remove strap.
- g. Lift battery off holder.

RATING	GROUP	CCA	VOLT	MAX. DIMENSION
Heavy Duty, Off-Road, Vibration Resistant	BCI 31A	950	12	13x6.81 x9.43 in. (330x173x240 mm).

- h. Position new battery on holder.
- i. Install strap (D) with bolt (C).

IMPORTANT

BATTERY IS NEGATIVE GROUNDED. Always connect starter cable to the positive (+) terminal of battery and battery ground cable to negative (-) terminal of battery. Reversed polarity in battery or alternator may result in permanent damage to electrical system.

- j. Attach negative (black) cable clamp (B) to negative post on battery and tighten clamp.
- k. Attach positive (red) cable clamp (A) to positive post on battery and tighten. Reposition plastic covers onto clamps.
- l. Switch battery disconnect switch to ON.
- m. Close hood.

MAINTENANCE/SERVICE

57.8.1.6 Preventing Electrical System Damage

- a. Carefully observe polarity when attaching booster battery.
- b. Do not short across battery or alternator terminals, or allow battery positive (+) cable or alternator wire to become grounded.
- c. Be sure alternator connections are correct before cables are connected to battery. Refer to illustration below.
- d. When welding on any part of the machine, disconnect battery cables and alternator wire.
- e. Always disconnect battery ground cable when working with the alternator or regulator.
- f. Never attempt to polarize alternator or regulator.
- g. If wires are disconnected from the alternator, use the illustration below to ensure proper reconnection.

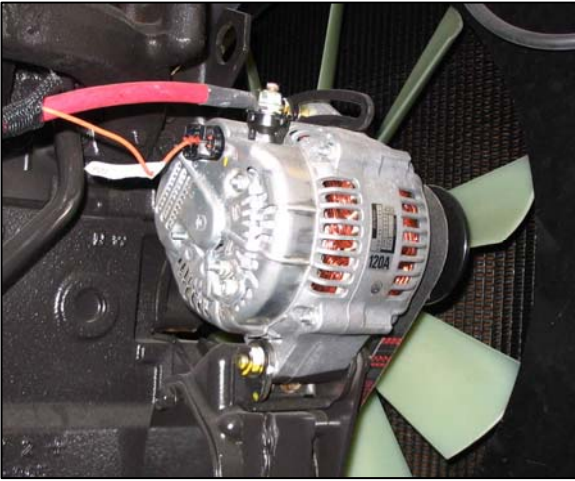

- h. Never ground the alternator field terminal or field circuit.
- i. Never connect or disconnect alternator or regulator wires with battery connected or alternator operating.
- j. Always disconnect cables from the battery when using a charger to charge battery in windrower.
- k. Ensure all cables are securely connected before operating engine.

MAINTENANCE/SERVICE

57.8.2 Headlights

57.8.2.1 Adjustment

Adjust for maximum illumination while ensuring oncoming traffic cannot be blinded by the lights. The recommended setting is:

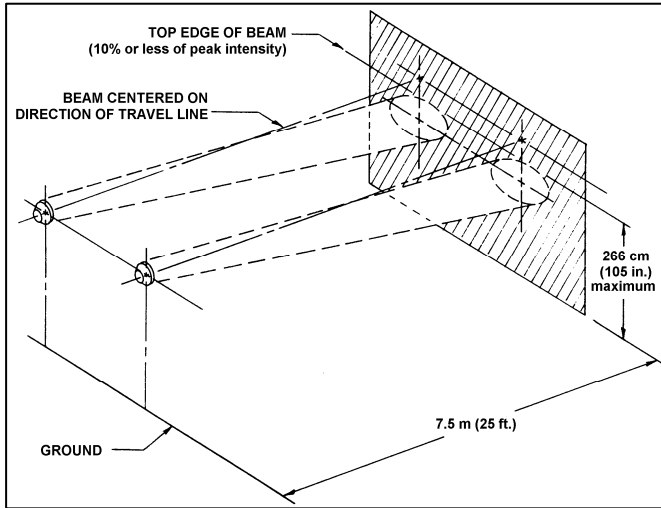

- Light beams laterally centered on the "direction of travel" line from the headlights (i.e. not skewed left or right).
- Upper limit of the beam not higher than 105 inches (266 cm) above ground at a distance of 25 ft. (7.5 m) from the headlight

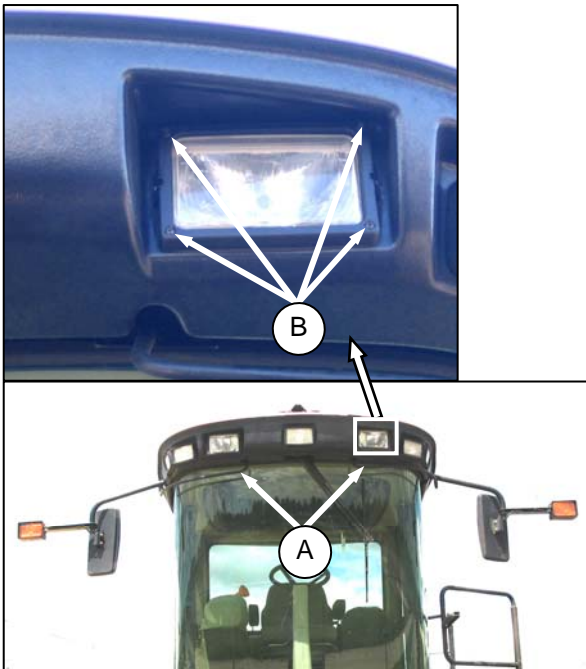

- Hold onto the hand-holds (A) on the cab front corners and stand on the header anti-slip strips.
- Adjust the lights with screws (B).

57.8.2.2 Bulb Replacement

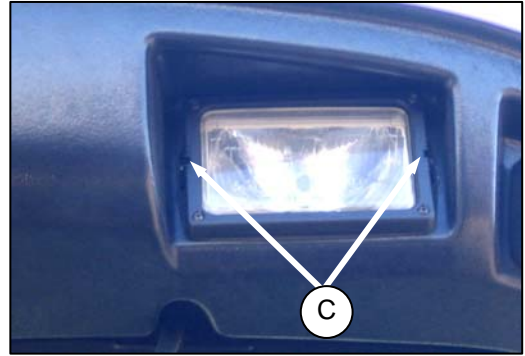

- Remove the two screws (C) and remove light assembly.

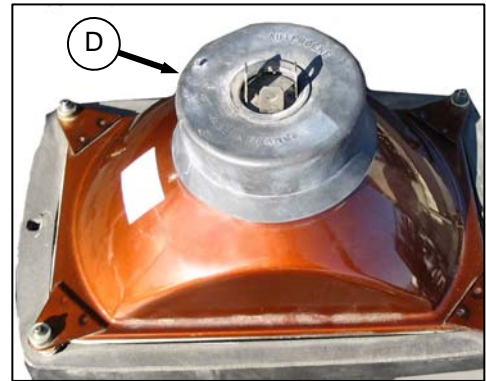

- Pull wiring harness connector off the headlight assembly and remove rubber insulator boot (D).

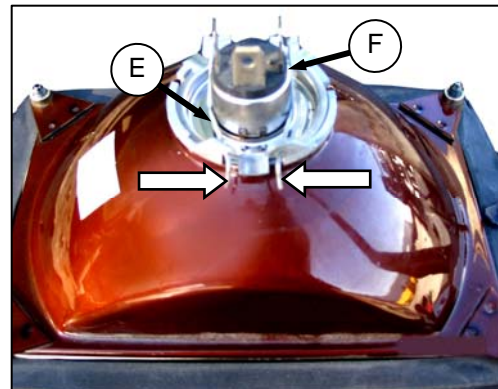

- Pinch the wire retainer (E) and lift away from hooks.
- Remove bulb (F) from body.

IMPORTANT

Do not touch the glass of the halogen bulb as the oils or other chemicals from your skin will cause the bulb to fail prematurely.

(continued next page)

MAINTENANCE/SERVICE

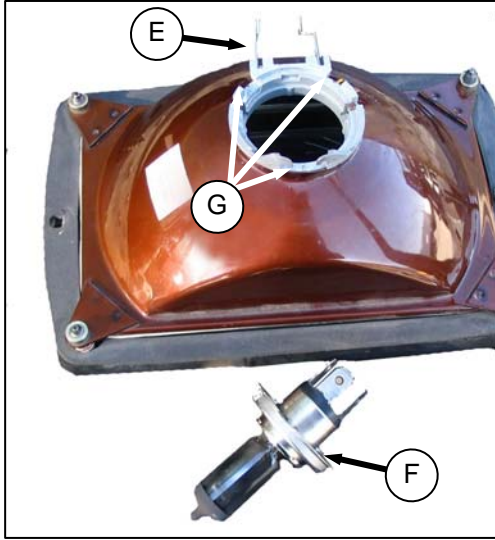

- e. Align lugs on new bulb with slots (G) in body and push into place.
- f. Secure bulb with wire retainer (E)

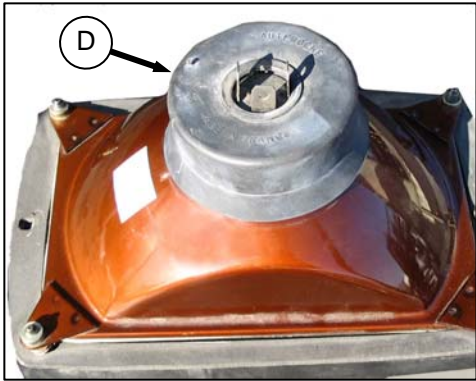

- g. Replace rubber insulator boot (D).
- h. Push connector onto light bulb.

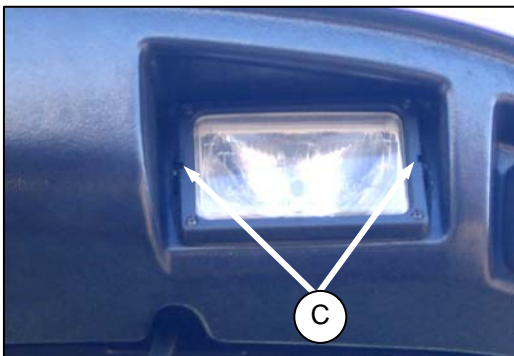

- i. Position headlight into light receptacle, ensuring top is up, and secure with screws (C).

NOTE

Aligning of light should not be necessary.

57.8.3 Flood Lights - Forward

The forward floodlights are not adjustable. Replace bulbs as follows:

- a. Shutdown engine and remove the key. Turn off the lights.

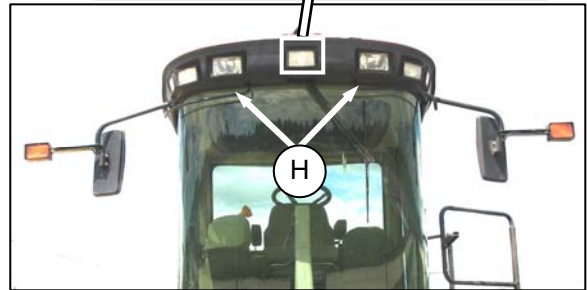
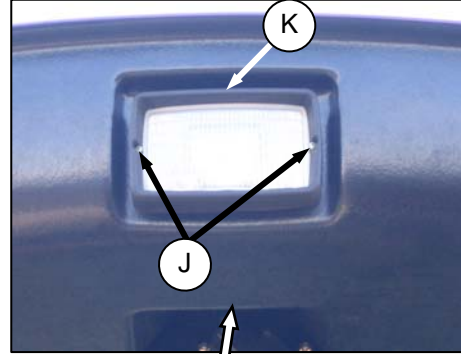

- b. Hold onto the hand-holds (H) on the cab front corners and stand on the header anti-slip strips when removing the forward field lights.
- c. Remove the two screws (J) and remove light bezel (K).
- d. Remove light from receptacle.

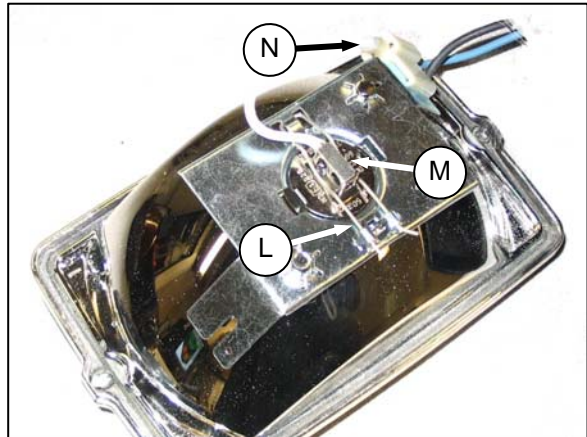

- e. Pinch the wire retainer (L) and lift away from hooks.
- f. Remove bulb (M) from body and pull wire from connector (N).

(continued next page)

MAINTENANCE/SERVICE

IMPORTANT

Do not touch the glass of the halogen bulb as the oils or other chemicals from your skin will cause the bulb to fail prematurely.

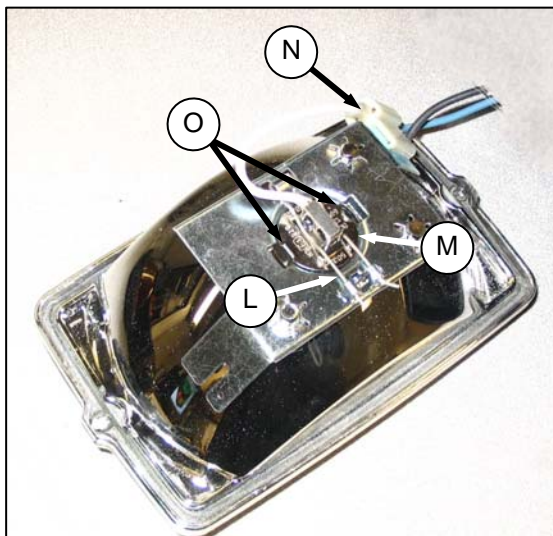

- g. Match slots on new bulb (M) with lugs (O) in optical unit and insert bulb into unit.
- h. Secure bulb with wire retainer (L).
- i. Push wire into connector (N).

IMPORTANT

For proper lighting pattern, be sure lights are installed right side up.

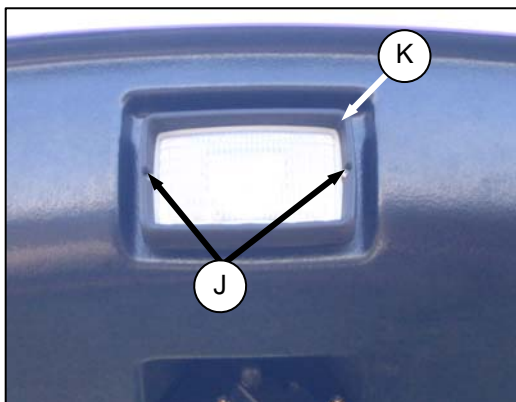

- j. Position light into light receptacle, ensuring top is up, and secure with bezel (K) and screws (J).

57.8.4 Flood Lights - Rear

57.8.4.1 Adjustment

The rear floodlights are best adjusted with the machine in the field or the equivalent to suit operator preference.

- a. Shutdown engine and remove the key. Turn on lights.

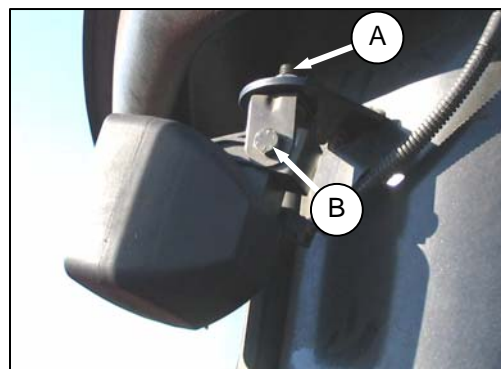

- b. Loosen bolts (A) and (B).
- c. Position light to desired position.
- d. Tighten bolts (A) and (B).

57.8.4.2 Bulb Replacement

- a. Shutdown engine and remove the key. Turn off the lights.

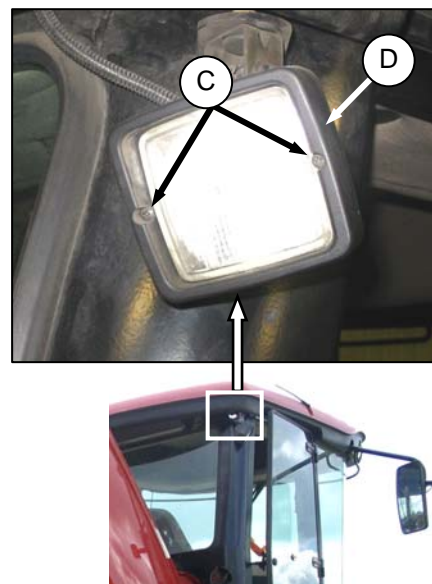

- b. Remove the two screws (C) and remove light bezel (D).
- c. Remove light from receptacle.

(continued next page)

MAINTENANCE/SERVICE

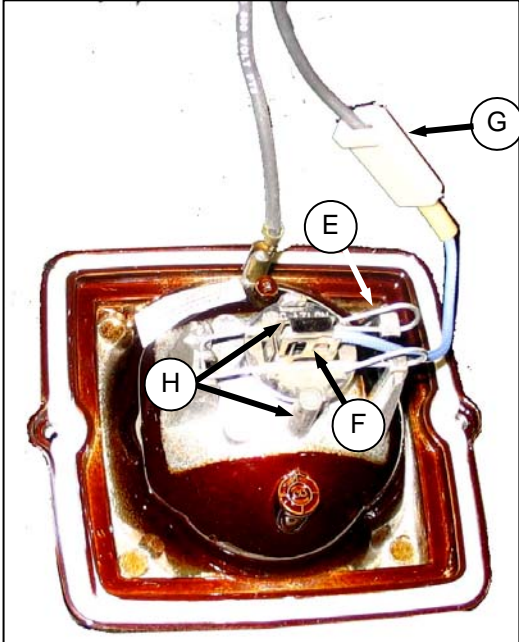

- d. Pinch the wire retainer (E) and lift away from hooks.
- e. Remove bulb (F) from body and pull wire from connector (G).

IMPORTANT

Do not touch the glass of the halogen bulb as the oils or other chemicals from your skin will cause the bulb to fail prematurely.

- f. Match slots on new bulb (F) with lugs (H) in optical unit and insert bulb into unit.
- g. Secure bulb with wire retainer (E).
- h. Push wire into connector (G).

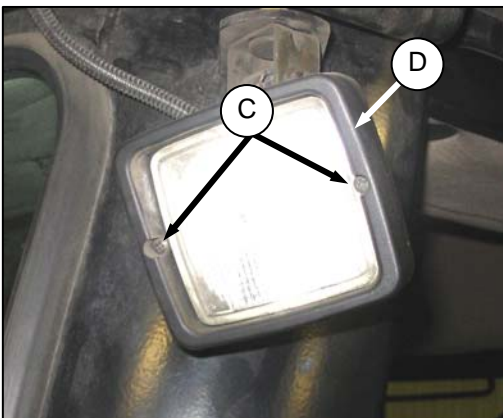

- i. Position light into light receptacle, ensuring top is up, and secure with bezel (D) and screws (C).

57.8.5 Swath Lights



DANGER

Stop engine and remove key from ignition before leaving operator's seat for any reason. A child or even a pet could engage an idling machine.

The swath lights are not adjustable. Replace bulbs as follows:

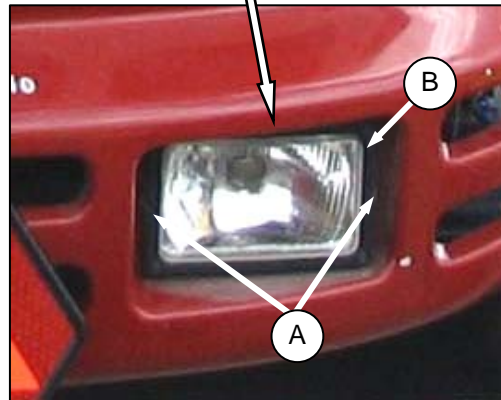

- a. Remove the two screws (A) and remove light bezel (B).
- b. Remove light from receptacle.

(continued next page)

MAINTENANCE/SERVICE

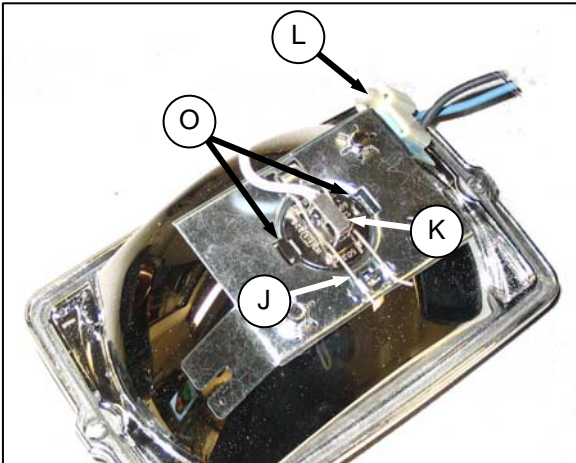

- c. Pinch the wire retainer (J) and lift away from hooks.
- d. Remove bulb (K) from body and pull wire from connector (L) .

IMPORTANT

Do not touch the glass of the halogen bulb as the oils or other chemicals from your skin will cause the bulb to fail prematurely.

- e. Match slots on new bulb (K) with lugs (O) in optical unit and insert bulb into unit.
- f. Secure bulb with wire retainer (J).
- g. Push wire into connector (L).

IMPORTANT

For proper lighting pattern, be sure lights are installed right side up.

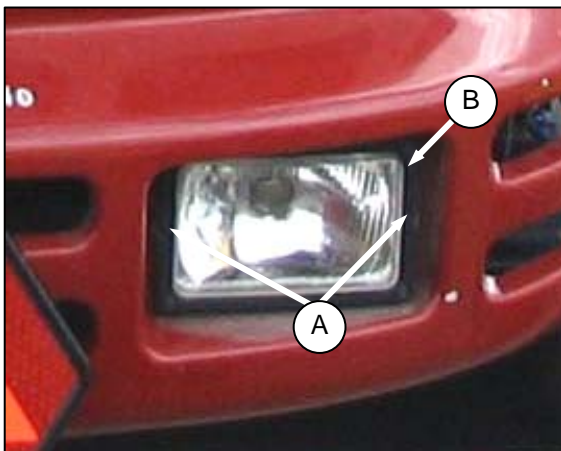

- h. Position light into light receptacle, ensuring top is up, and secure with bezel (B) and screws (A).

57.8.5.1 Red Tail Lights

- a. Shutdown engine and remove the key. Turn off the lights.

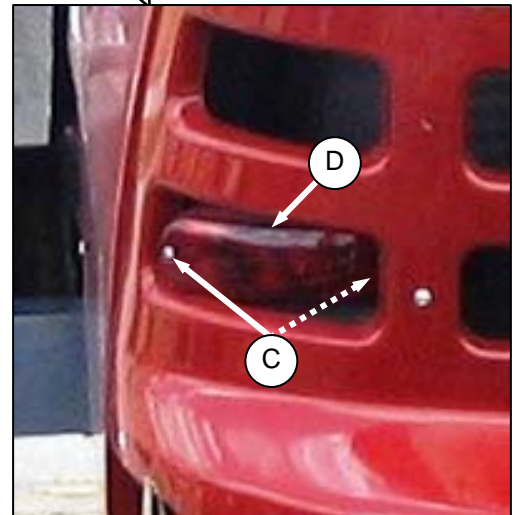

- b. Remove two screws (C) from light (D) and remove light.
- c. Remove connector from light.
- d. Connect wiring harness to new light and install light with screws (C).

MAINTENANCE/SERVICE

57.8.5.2 Amber Lights

- Shutdown engine and remove the key. Turn off the lights.

NOTE

Hold onto the hand-holds (A) on the cab front corners and stand on the header anti-slip strips or stand on the maintenance platform when accessing the amber lights.

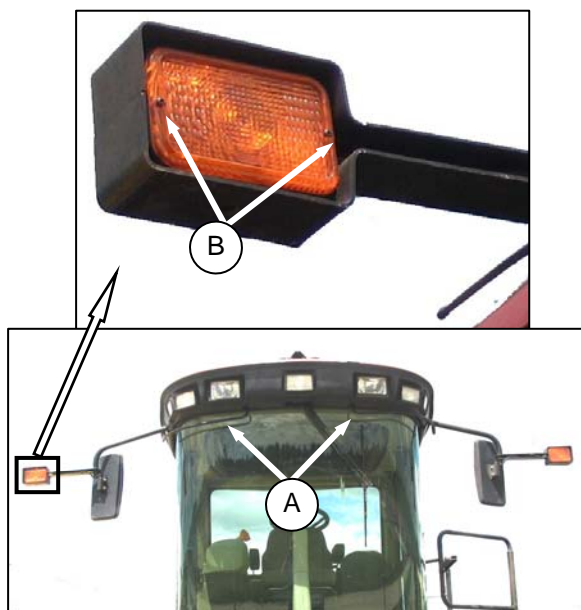

- Remove two screws (B) from lens and remove lens.
- Push and twist light bulb to remove from socket.
- Install new bulb ensuring that bulb base is properly engaged in socket. Use Bulb Trade #1156.
- Reinstall lens with screws (B).

57.8.5.3 Dome Light

- Shutdown engine.

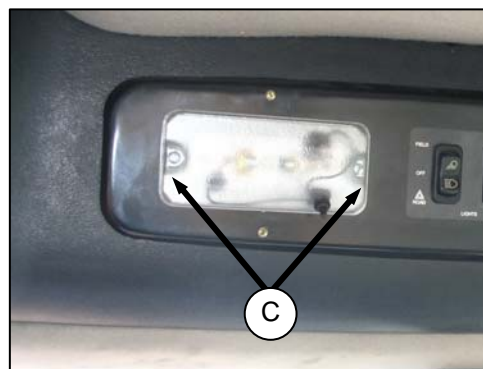

- Remove two screws (C) from plastic lens and remove lens.
- Replace bulb.
- Reinstall plastic lens with screws (C).

57.8.6 Ambient Light

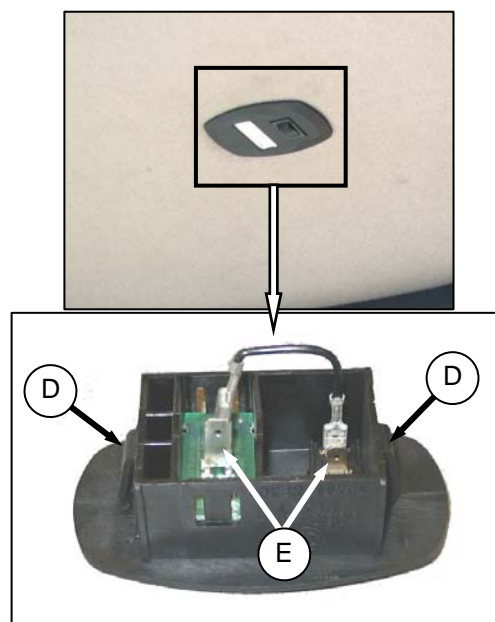

- Shutdown engine.
- Push against tabs (D) with a screwdriver and pull ambient light fixture out of cab roof.
- Remove connectors (E).
- Connect wires to new light fixture.
- Push into place in cab roof until tabs hold fixture in place.

57.8.7 Turn Signal Indicators

If the turn signal indicators on the CDM do not function, contact your Windrower dealer.

MAINTENANCE/SERVICE

57.8.8 Circuit Breakers and Fuses



DANGER

Stop engine and remove key from ignition before leaving operator's seat for any reason. A child or even a pet could engage an idling machine.

The circuit breakers and fuses are located inside the fuse box that is mounted on the frame on the right side of the windrower. The circuit breakers automatically reset and the fuses are the plastic blade type.

Access the breakers and fuses as follows:

- Stop engine and remove key.

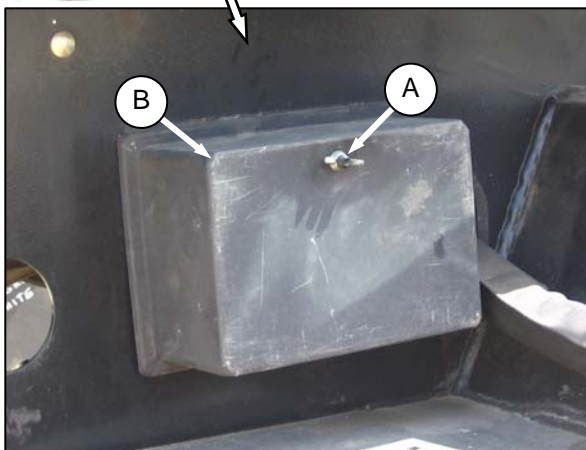

- Remove wing nut (A) and remove fuse box cover (B).
- Refer to decal on inside of cover for identification of fuses and circuit breakers. See illustration next page. SEE BG

57.8.8.1 Checking/Replacing Fuses

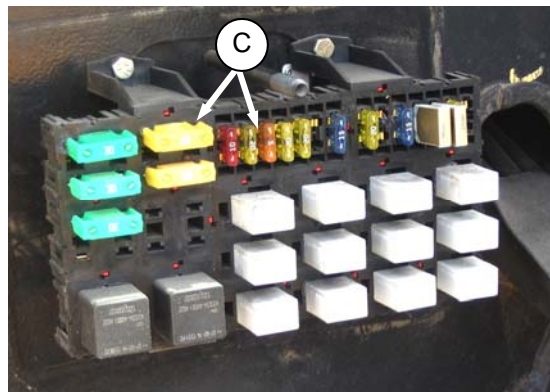

- To check fuse, pull fuse (C) out of receptacle and visually examine.
- To replace fuse, insert new fuse into receptacle.

IMPORTANT

Replacement fuses should match rating on decal shown on following page.

57.8.8.2 Replacing Circuit Breakers

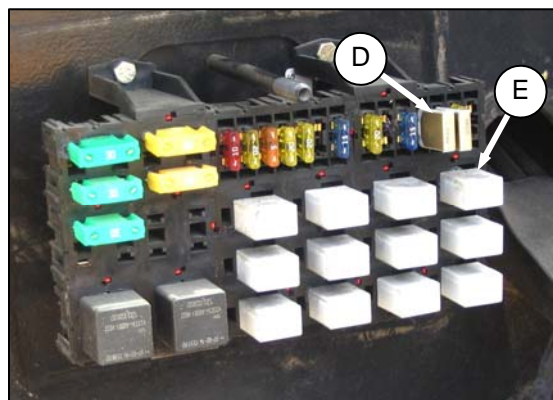

- To replace circuit breaker (D), pull breaker out of receptacle, and install new circuit breaker.
- To replace relay (E), pull relay out of receptacle, and install new relay.
- Reinstall cover and secure with wing nut.

MAINTENANCE/SERVICE

57.8.8.3 Fuse Box Decal

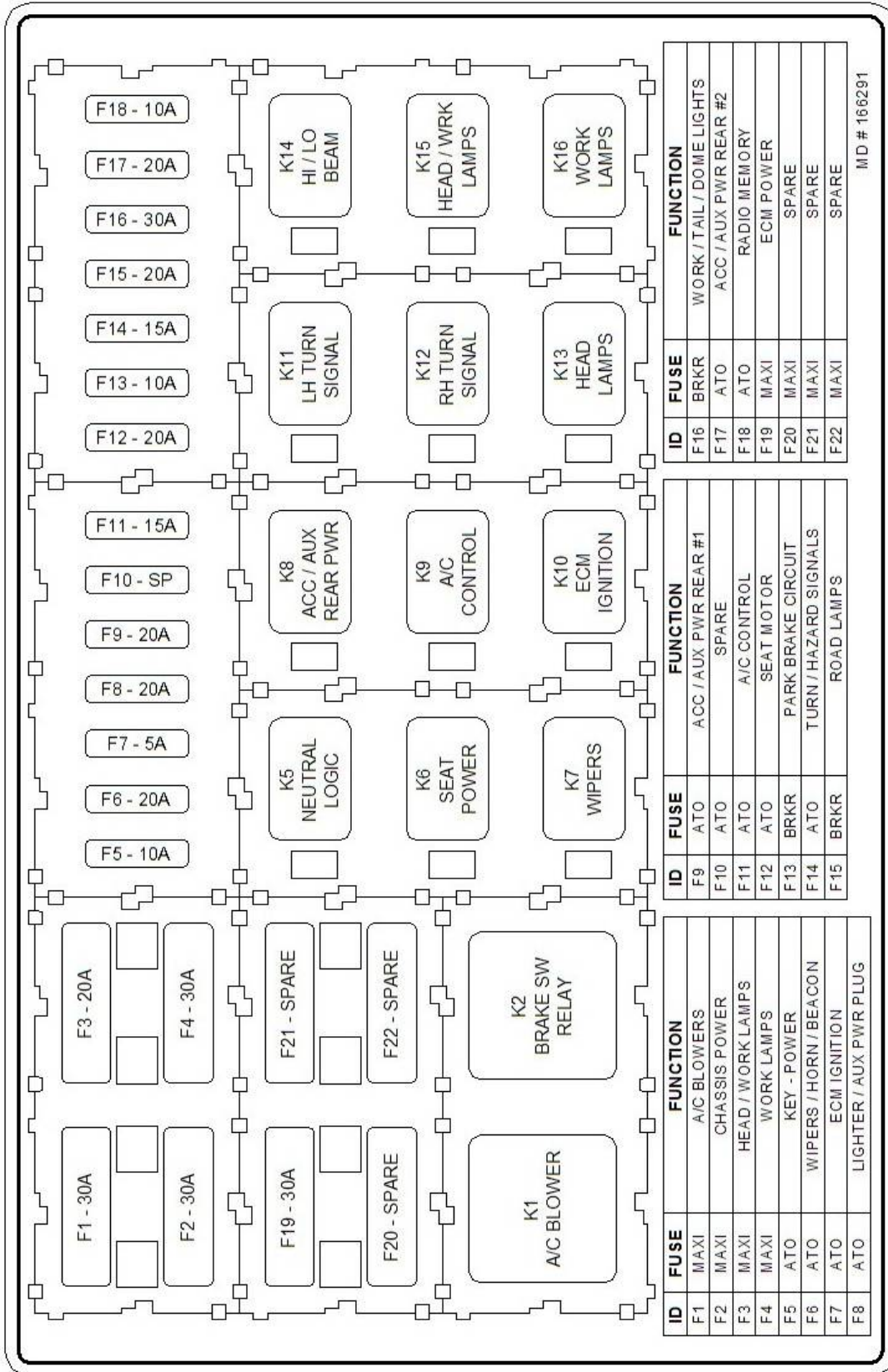

MAINTENANCE/SERVICE

57.8.8.4 Main Fuses - 125 Amp

The 125 amp main fuse holders are located inside the frame beside the battery and are accessed from underneath the windrower.

- a. Stop engine and remove key.

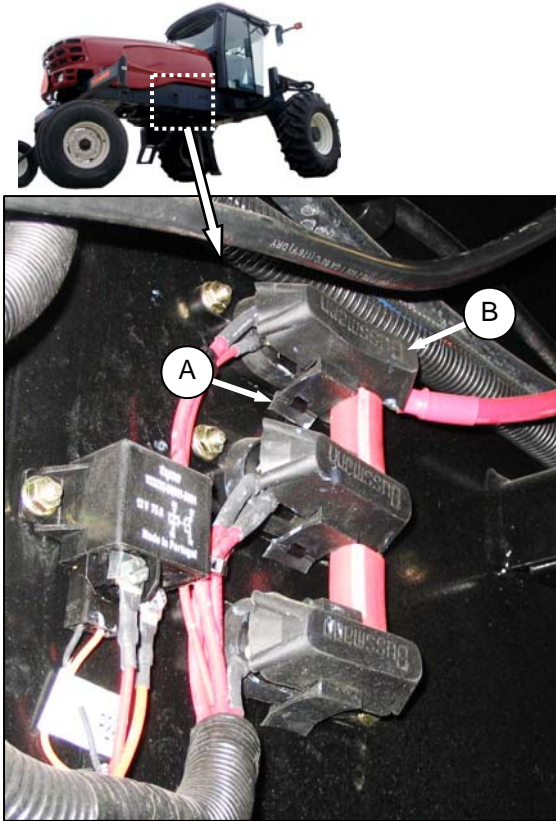

- e. Install new fuse on studs and any existing wiring that was removed.
- f. Secure with nuts (D).
- g. Close cover (B) and secure with tab (A).

- b. To check condition of fuse, pull tab (A) and open cover (B).

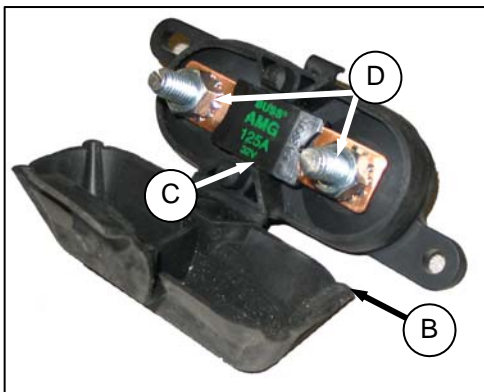

- c. Visually examine fuse (C) for indications of melting.
- d. To remove fuse (C), remove two nuts (D) and pull fuse free from holder. Existing wiring may need to be pulled off the stud first.

MAINTENANCE/SERVICE

57.9 HYDRAULIC SYSTEM

The M100 Windrower hydraulic system provides oil for the windrower drive system, and header lift and drive systems.

Hydraulic schematics are placed at the back of this manual.



WARNING

Avoid high pressure fluids. Escaping fluid can penetrate the skin causing serious injury. Relieve pressure before disconnecting hydraulic lines. Tighten all connections

before applying pressure. Keep hands and body away from pin-holes and nozzles which eject fluids under high pressure. Use a piece of cardboard or paper to search for leaks. If ANY fluid is injected into the skin, it must be surgically removed within a few hours by a doctor familiar with this type of injury or gangrene may result.



IMPORTANT

Dirt, dust, water and foreign material are the major causes of trouble developing in the hydraulic system. If the hydraulic system should be disconnected for service, protect the ends of hoses, tubing and ports of components from contamination with clean, lint-free towels or clean plastic bags. Before installing any replacement hose, flush the inside of it with unused diesel fuel or unused commercial petroleum cleaning solvent for ten seconds minimum. Do not use water, water soluble cleaners or compressed air.

IMPORTANT

The components in this system are built to very close tolerances and have been adjusted at the factory. Do not attempt to service these components except to maintain proper oil level, change oil and filters and to adjust relief pressures as described in this manual. See your Windrower Dealer for all other service.

57.9.1 Oil Level

Check hydraulic oil level when oil is cold for most accurate reading:



DANGER

Stop engine and remove key from ignition before leaving operator's seat for any reason. A child or even a pet could engage an idling machine.

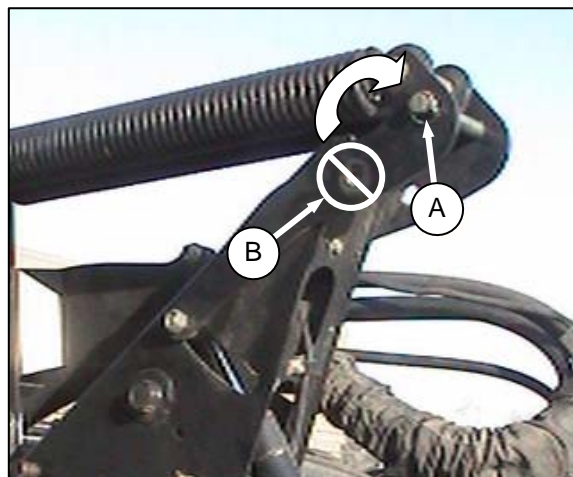

IMPORTANT

To prevent damage to the lift system when lowering header lift linkages without a header or weight box attached to windrower, ensure that float engagement pin is installed in storage location (A), and **not** installed at hole location (B).

- Park windrower on level ground and lower header and reel so that lift cylinders are fully retracted.
- Stop engine and remove key.



- Stand on platform to access the filler pipe.
- Turn filler cap counterclockwise to loosen bung, and remove dipstick.

(continued next page)

MAINTENANCE/SERVICE

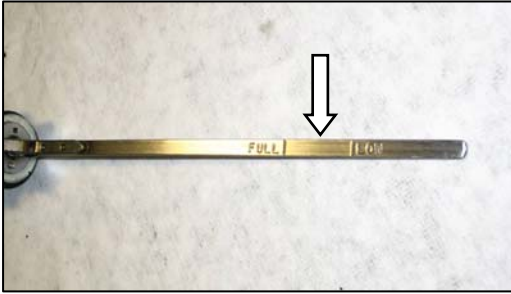

- e. Maintain level between LOW and FULL marks. If necessary, add SAE 15W40 Compliant with SAE Specs for API Class SJ and CH-4 Engine Oil.

NOTE

LOW to FULL capacity is approximately 1 U.S. gallon (4 liters).

- f. Reinstall filler cap and turn clockwise to tighten bung.

MAINTENANCE/SERVICE

57.9.2 Changing Hydraulic Oil

NOTE

Change hydraulic oil every 2000 hours.

- Stop engine and remove key.
- Open engine compartment hood to highest position.

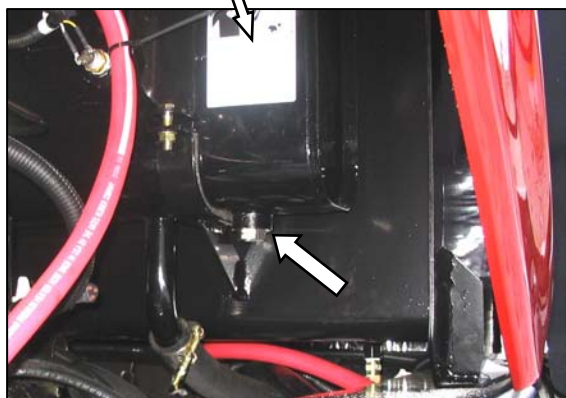

- Place a suitable container (at least 20 gal. US (75 liters)) under drain to collect oil.
- Remove drain plug from bottom of hydraulic oil reservoir and allow oil to drain.
- Clean off any metal debris that may have accumulated on magnetic drain plug. Replace and tighten drain plug.
- Add oil to the tank to the required level through the filler pipe. Refer to previous section.

57.9.3 Hydraulic Oil Cooler

The hydraulic oil cooler is located inside the cooling box behind the radiator. It should be cleaned daily with compressed air. Refer to Section 7.9.2 Cooling Box Maintenance.

57.9.4 Hydraulic Oil Filters

NOTE

Change hydraulic oil filters after the first 50 hours of operation and every 500 hours thereafter. Filter (A) part #112420 and filter (B) part #151975 can be obtained from your dealer.

The hydraulic system contains two filters. Change hydraulic oil filters as follows:



DANGER

Stop engine and remove key from ignition before leaving operator's seat for any reason. A child or even a pet could engage an idling machine.

- Stop engine and remove key.

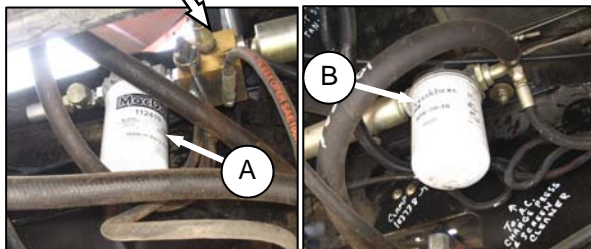

- Clean around heads of the filters (A) and (B).
- Unscrew the filters with a filter wrench.
- Clean the gasket surface of the filter heads.
- Fill new filters with clean oil and apply a thin film of clean oil to the filter gaskets.
- Screw the new filters onto the mount until the gasket contacts the filter head.
- Tighten filters an additional $\frac{1}{2}$ turn by hand.

IMPORTANT

Do not use a filter wrench to install oil filter. Over-tightening can damage gasket and filter.

MAINTENANCE/SERVICE

57.9.5 Header and Reel Hydraulics

57.9.5.1 Pressure Compensator Valve

The pressure compensator valve is pre-set to be sufficient for all header sizes and options. See table below.

When the knife drive pressure approaches the compensator valve setting, a warning tone sounds on the CDM, indicating a potential overload on the header drive. If operation continues, and the pressure reaches the setting, the compensator valve is activated. The header

drive will begin to slow down. To avoid overheating the drive pumps, reduce the ground speed to maintain the correct system load and knife drive operation.

NOTE

The warning tone is normal when the operating pressure is very close to the compensator valve pressure setting.

If lift and reel or draper drive capacity problems develop, the pressure compensator valve may require adjusting. Contact your Windrower Dealer or refer to the Technical Service Manual for your Windrower.

HEADER MODEL	APPLICATION/SYSTEM	SUGGESTED OVERLOAD WARNING SETTING psi (kPa)	WINDROWER PRESSURE COMP SETTING psi (kPa)
D60 & A40D	Reel/Draper Pressure	3000 (20684)	3200 (22063)
D60 & A40D	Knife/Conditioner Pressure	4000 (27579)	4200 (28958)

57.9.5.2 Reel/Conveyor Flow Control Block

Two hydraulic valve blocks control the reel and conveyor functions, and are controlled by the Windrower Control Module (WCM) according to the inputs from the operator. The valve blocks are located behind the maintenance platform.

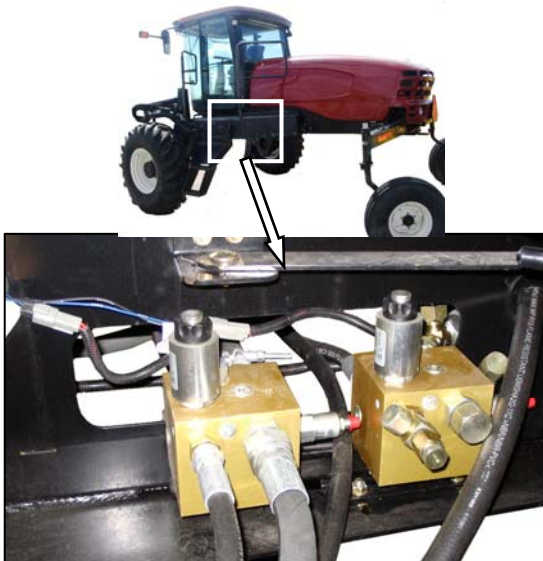

The valve blocks do not require any scheduled maintenance other than to check for leaking fittings or loose electrical connections. If service is required, contact your Windrower Dealer or

refer to the Technical Service Manual for your Windrower.



57.9.5.3 Knife Drive Valve Block

The ON/OFF valve on the valve block regulates the knife speed, and is mounted on top of the

MAINTENANCE/SERVICE

knife drive pump. The flow to the knife drive is mechanically set on the pump itself.

MAINTENANCE/SERVICE

57.9.5.4 Header Drop Rate

The header should lower gradually when the lower header switch is pressed. From full height to ground should take approximately 3.5 seconds.

Adjust as follows:



DANGER

Stop engine and remove key from ignition before leaving operator's seat for any reason. A child or even a pet could engage an idling machine.

- a. Lower header to ground, stop engine, and remove key.

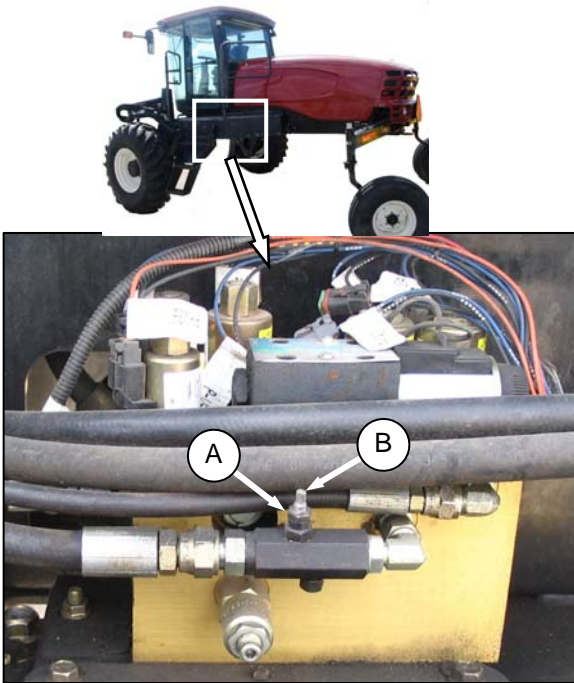

- b. Move maintenance platform rearward.
- c. Loosen jam-nut (A) on needle valve and turn screw (B) clockwise to decrease the drop rate and counter-clockwise to increase the drop rate.
- d. Tighten jam-nut (A).
- e. Close platform and engine compartment hood.
- f. Check drop rate and re-adjust as required.

MAINTENANCE/SERVICE

57.9.6 Traction Drive Hydraulics

57.9.6.1 Transmission Oil Pressure

The windrower transmission consists of two variable displacement axial piston hydraulic pumps, one for each drive wheel. The pumps are direct driven through a coupling to the engine. Each pump requires charge flow to make up for internal leakage, maintain positive pressure in the main circuit, provide flow for cooling and replace any leakage losses from external valving or auxiliary systems. The charge pressure is monitored and if it drops below 150 psi (1035 kPa), the CDM sounds a tone and displays a flashing warning. Refer to Section 5.17.4 Warnings and Alarms.

IMPORTANT

Rated charge pressure must be maintained under all conditions of operation to prevent damage to the transmission.

If the TRANS OIL PRESSURE warning is displayed, shutdown the engine and proceed as follows:

- Check the hydraulic fluid level in the tank. Refer to Section 7.11.1 Oil Level.

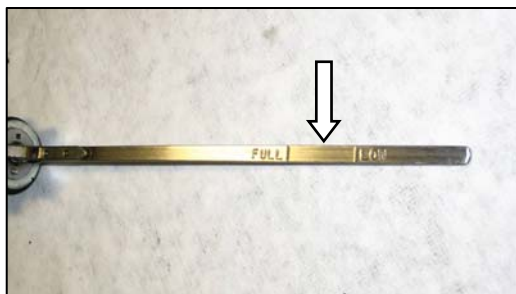

- Check the hoses and lines for leakage.
- Check the charge pressure relief valve. Refer to following section.
- If charge pressure still cannot be maintained, do not operate the windrower. Contact your windrower dealer.

57.9.6.2 Charge Pump Pressure

Incorrect charge pressure settings may result in the inability to build required system pressure and/or inadequate loop flushing flows. Correct charge pressure must be maintained under all conditions to maintain pump control performance and to operate the brake release

Check and adjust charge pump pressure as follows:



DANGER

Stop engine and remove key from ignition before leaving operator's seat for any reason. A child or even a pet could engage an idling machine.

- Open engine compartment hood fully.

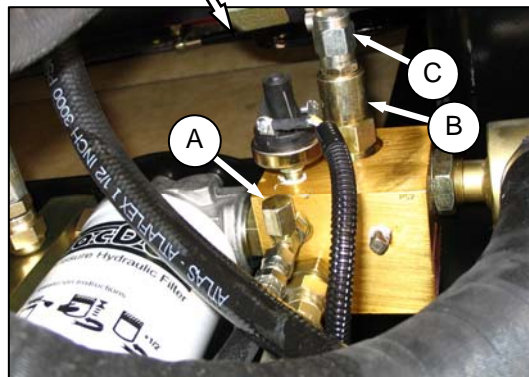

- Remove cap (A) at fitting.
- Attach a 0 - 600 psi (4000 kPa) pressure gauge to a hose that is long enough to allow pressure gauge to be read from the operator's seat. Attach hose to the fitting.
- Start engine and leave at idle. Pressure should be 200 to 250 psi (1379 to 1724 kPa) with the hydraulic oil at 100°F. (40°C) minimum.
- If pressure is not within this range, adjust relief pressure as follows:
 - Shut off engine and remove key.
 - Remove cap (C) from relief valve (B) for access to adjustment screw.

(continued next page)

MAINTENANCE/SERVICE

3. Hold screw (D) with Allen wrench (E) and loosen jam-nut (F).

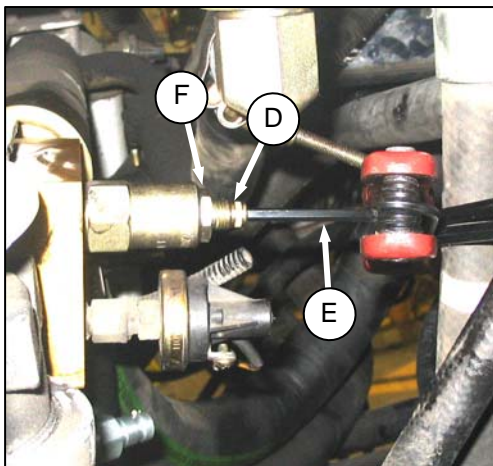

4. Adjust screw as required.
 5. Repeat checking and adjustment until relief pressure is correct, then tighten jam-nut (E) while holding screw (D). Replace cap (C).
- f. If relief pressure does not increase after adjusting two or three times, check relief valve as follows:

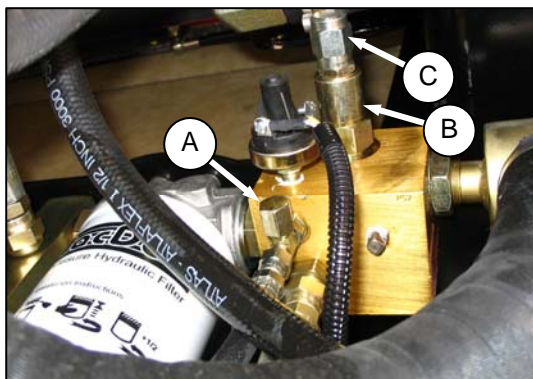

1. Remove relief valve (B) from manifold.
 2. Check that no contaminant is preventing the spring-loaded poppet from properly seating against the valve body.
 3. Clean as required with a solvent type cleaner and compressed air, and reinstall valve.
 4. Check all seals for integrity.
 5. Reset adjustment screw to original position before checking relief pressure.
- g. Remove pressure gauge hose and reinstall cap (A) to fitting.

57.9.7 Hoses and Lines

Check hydraulic hoses and lines daily for signs of leaks.



WARNING

Avoid high-pressure fluids. Escaping fluid can penetrate the skin causing serious injury. Relieve pressure before disconnecting hydraulic lines. Tighten all connections before applying pressure. Keep hands and body away from pin-holes and nozzles which eject fluids under high pressure.



If ANY fluid is injected into the skin, it must be surgically removed within a few hours by a doctor familiar with this type of injury or gangrene may result. Use a piece of cardboard or paper to search for leaks.

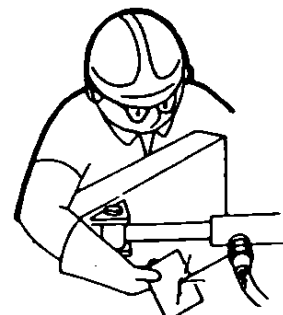

IMPORTANT

Keep hydraulic coupler tips and connectors clean. Dust, dirt, water and foreign material are the major causes of hydraulic system damage. DO NOT attempt to service hydraulic system in the field. Precision fits require WHITE ROOM CARE during overhaul.

MAINTENANCE/SERVICE

57.10 WHEELS AND TIRES

57.10.1 Drive Wheels

57.10.1.1 Tire Inflation

- a. Visually check daily that tires have not lost pressure. Under-inflation of drive tires can cause side wall cracks.



DANGER

To avoid severe personal injury or death caused by machine runaway, shut off engine and remove key before performing any of the following checks and/or adjustments.

- b. Measure tire pressure annually with a gauge. Maintain the pressure as follows:

Bar – 32 psi (221 kPa)

Turf – 20 psi (138 kPa)



DANGER

- Never install a tube in a cracked wheel rim.
- Never weld a wheel rim.
- Make sure all the air is removed from a tire before removing the tire from the rim.
- Never use force on an inflated or partially inflated tire. Make sure the tire is correctly seated before inflating to operating pressure.
- Do not remove, install or make repairs to a tire on a rim unless you have the proper equipment and experience to perform the job. Take the tire and rim to a qualified tire repair shop.
- If the tire is not in correct position on the rim, or if too full of air, the tire bead can loosen on one side, causing air to leak at high speed and with great force. An air leak of this nature can thrust the tire in any direction, endangering anyone in the area.
- Do not exceed manufacturer's recommended inflation pressure.

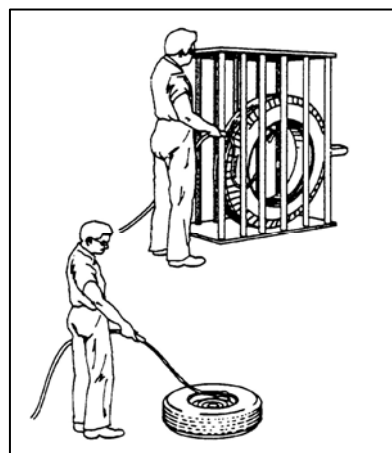

- Use a safety cage if available.
- Do not stand over tire. Use a clip-on chuck and extension hose.

57.10.1.2 Wheel Nut Torque

At first use, or when a wheel is removed, check drive wheel nut torque every 15 minutes on the road or 1 hour in the field until the specified torque is maintained. Continue with a checking schedule of 10 and 50 hours (field or road operation), and then every 200 hour intervals thereafter.

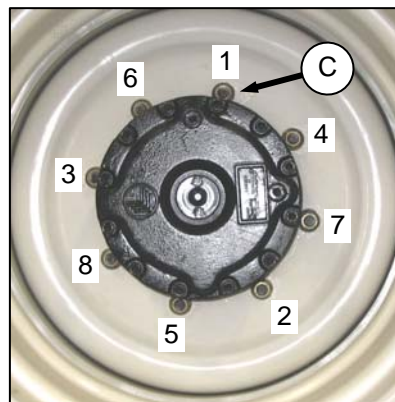

- a. Tighten nuts (C) to 220 ft-lbf (300 N·m) using the tightening sequence as shown.

NOTE

To avoid damage to wheel disks, do not over-tighten wheel nuts.

- b. Repeat sequence three times.

MAINTENANCE/SERVICE

57.10.1.3 Lubricant

The drive wheel gearbox lubricant should be changed after the first 50 hours. Check the level every 200 hours or annually and change every 1000 hours. The windrower should be on level ground when checking lubricant level.

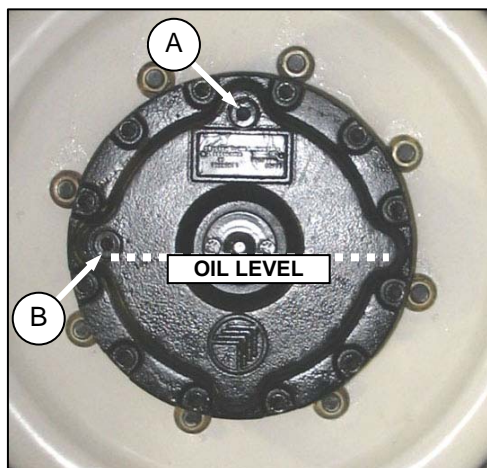

- a. Check the lubricant as follows:
 1. Rotate wheel so that plug (A) is located at the top as shown.
 2. Remove plug (B). The lubricant should be visible through the hole or slightly running out.

NOTE

Type of lubricant used after first lubricant change is different from factory supplied lubricant.

- b. If lubricant needs to be added, remove plug (A), and add lubricant until lubricant runs out at (B). Prior to first change, use SAE 85W-140, API Service, Class GL-5, Extreme Pressure Gear Lubricant. After first change, use SAE 75W-90, API Service, Class GL-5, Fully Synthetic Transmission Lubricant (SAE J2360 preferred).
- c. Replace plugs and tighten.

- d. Change the lubricant as follows:

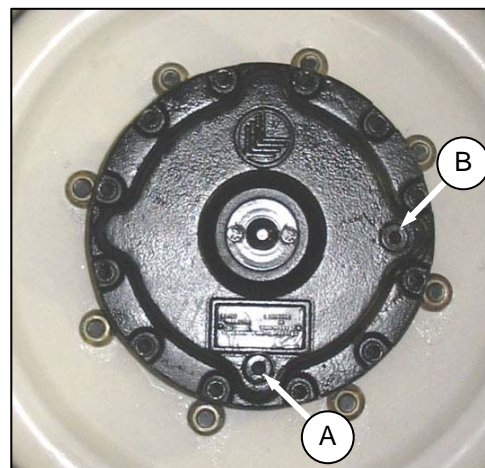

1. Rotate the wheel so that plug (A) is located at the bottom.
2. Place a large enough container (about 2 quarts U.S. (2 liters) under the drain plug (A).
3. Remove plugs (A) and (B) and drain lubricant. Ideally, the lubricant should be at operating temperature for good draining.
4. When lubricant has drained, rotate wheel so that plug (A) is at the top.

NOTE

Type of lubricant used after first lubricant change is different from factory supplied lubricant.

5. Add lubricant through (A) until lubricant runs out of hole at (B). Use SAE 75W-90, API Service, Class GL-5, Fully Synthetic Transmission Lubricant (SAE J2360 preferred). Drive wheel gearbox capacity is 1.5 qts. U.S. (1.4 liters).
6. Replace both plugs and tighten.

MAINTENANCE/SERVICE

57.10.1.4 Drive Wheel Removal/Installation



DANGER

To avoid severe personal injury or death caused by machine runaway, shut off engine and remove key before performing any of the following checks and/or adjustments.

- a. Remove header.
- b. Park windrower on level ground and block all wheels.
- c. Place GSL in N-DETENT, shutdown engine and remove key.

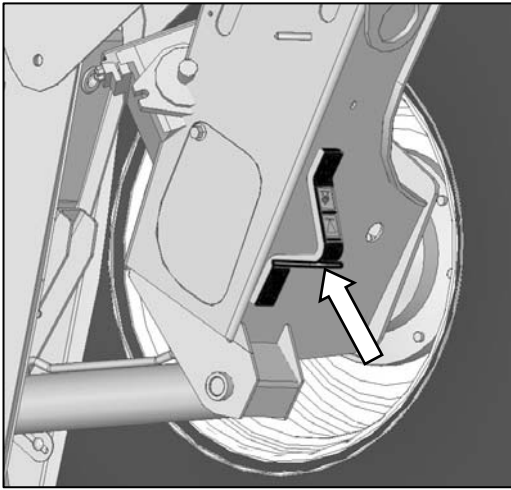

- d. Position a 5000 lb (2270 kg) jack under leg jack point and raise windrower wheel slightly off ground.

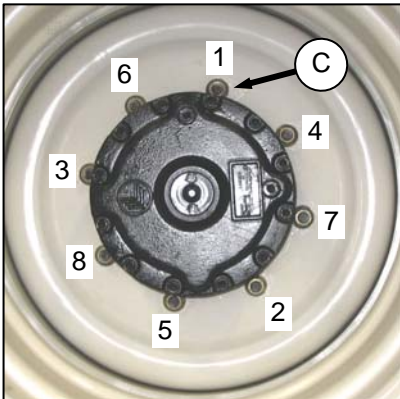

- e. Undo wheel nuts (C) and remove wheel.
- f. To install new tire, ensure that air valves are on outside and tire tread point forward. For "Turf" tires (diamond tread), be sure arrow on sidewall points in forward rotation.
- g. Position wheel on hub and install wheel nuts (C).
- h. Tighten nuts (C) to 220 ft-lbf (300 N·m) using the tightening sequence as shown.

NOTE

To avoid damage to wheel disks, do not over-tighten wheel nuts.

- i. Repeat sequence three times.
- j. Lower windrower and remove jack.

MAINTENANCE/SERVICE

57.10.2 Caster Wheels

57.10.2.1 Tire Inflation

- a. Visually check daily that tires have not lost pressure. Under-inflation of drive tires can cause side wall cracks.



DANGER

To avoid severe personal injury or death caused by machine runaway, shut off engine and remove key before performing any of the following checks and/or adjustments.

- b. Measure tire pressure annually with a gauge. Maintain the pressure at 10 psi (69 kPa).

NOTE

If caster wheels shimmy a possible cause is over-inflation:



DANGER

- Never install a tube in a cracked wheel rim.
- Never weld a wheel rim.
- Make sure all the air is removed from a tire before removing the tire from the rim.
- Never use force on an inflated or partially inflated tire. Make sure the tire is correctly seated before inflating to operating pressure.
- Do not remove, install or make repairs to a tire on a rim unless you have the proper equipment and experience to perform the job. Take the tire and rim to a qualified tire repair shop.
- If the tire is not in correct position on the rim, or if too full of air, the tire bead can loosen on one side, causing air to leak at high speed and with great force. An air leak of this nature can thrust the tire in any direction, endangering anyone in the area.

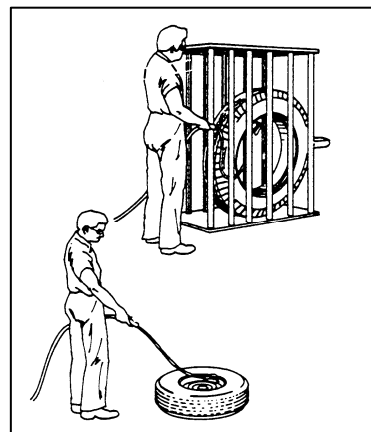

- Use a safety cage if available.
- Do not stand over tire. Use a clip-on chuck and extension hose.

MAINTENANCE/SERVICE

57.10.2.2 Ballast Requirements

Fluid ballasting of rear caster tires is recommended to provide adequate machine stability when using large headers on the windrower. Also, the stability of machine varies with different attachments, windrower options, terrain and operator's driving technique.

Ballast capability per tire is at a maximum fill of 75% or when fluid is level with valve stem when the stem is positioned at 12 o'clock. Fluid can be added to any level up to maximum fill and always add an equal amount of fluid on both sides.

TIRE SIZE	FLUID PER TIRE AT 75% FILL U.S. Gal. (Liters)	TOTAL WEIGHT OF BOTH TIRES lb (kg) *
7.5X16 (A)	10 (38)	200 (91)
10X16 (B)	18 (69)	380 (170)
16.5X16.1 (C)	41 (158)	830 (377)

* Weights are given for typical calcium chloride and water mixtures. Weight is reduced by 20% if only water is used (for areas that do not require anti-freeze protection).

HEADER DESCRIPTION		RECOMMENDED BALLAST				RECOMMENDED TIRE SIZE
		LEVEL GROUND		HILLS		
TYPE	SIZE	PER TIRE	BOTH TIRES	PER TIRE	BOTH TIRES	
		U.S. Gal. (Liters)	lb (kg) *	U.S. Gal. (Liters)	lb (kg) *	
A & D Series All Options	25' and Down	0	0	0	0	A,B,C
D Series	30' Single Or Split Reel W/O Conditioner. 35' Single Reel	0	0	10 (38)	200 (91)	A,B,C
	30' Split Reel. Steel Fingers & Conditioner. 35' Split Reel (5 Or 6 Bat)	18 (69)	380 (170)	30 (115)	630 (288)	Level Ground – B, C Hills - C

* If only water is used, increase volume of water by 20% (up to maximum allowable fill per tire) to compensate.

MAINTENANCE/SERVICE

57.10.2.3 Wheel Nut Torque

At first use, or when a wheel is removed, check caster wheel bolt torque as follows after 5 hours and then at 200 hour intervals:

Forked Casters

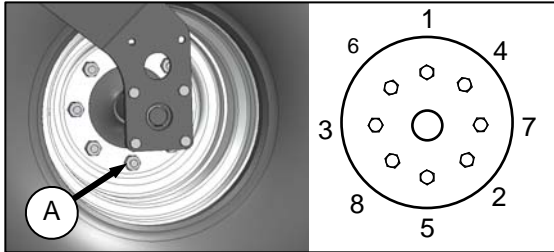

- Tighten nuts (A) to 120 ft·lbf (163 N·m) using the tightening sequence as shown.

NOTE

To avoid damage to wheel disks, do not over-tighten wheel nuts.

- Repeat sequence three times.

Formed Casters

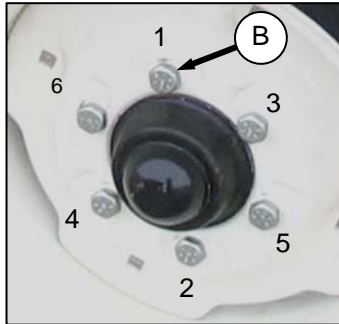

- Tighten bolts (B) to 120 ft·lbf (163 N·m) using the tightening sequence as shown.

NOTE

To avoid damage to wheel disks, do not over-tighten wheel bolts.

- Repeat sequence three times.

57.10.2.4 Forked Caster Wheel Removal/Installation



DANGER

To avoid severe personal injury or death caused by machine runaway, shut off engine and remove key before performing any of the following checks and/or adjustments.

- Remove the caster wheel as follows:
 - Park windrower on level ground and block all wheels.
 - Place GSL in N-DETENT, shutdown engine and remove key.
 - Raise end of walking beam using a 2000 lb (908 kg) capacity jack or other suitable lifting device until the wheel is slightly off the ground.

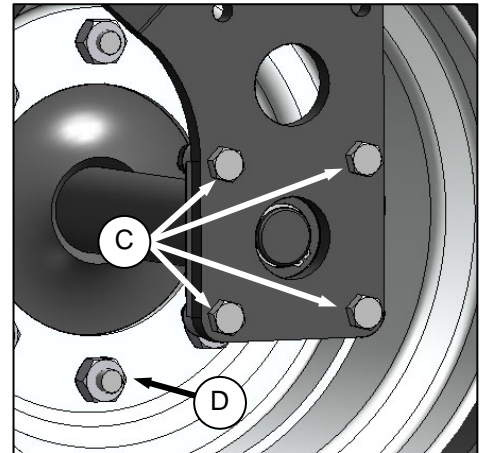

- Remove the eight bolts (C) attaching axle to forked caster and remove wheel assembly from caster.
 - Undo the eight wheel nuts (D) and remove wheel from axle.
- Install the caster wheel as follows:
 - Position wheel on axle and install wheel nuts (D).
 - Torque nuts (D) as specified in previous section.
 - Position wheel assembly in forked caster and install with bolts (C). Torque bolts to 75-79 ft·lbf (97-107 N·m).
 - Lower windrower and remove jack.

MAINTENANCE/SERVICE

57.10.2.5 Formed Caster Wheel Removal/Installation



DANGER

To avoid severe personal injury or death caused by machine runaway, shut off engine and remove key before performing any of the following checks and/or adjustments.

- a. Remove the caster wheel as follows:
 1. Park windrower on level ground and block all wheels.
 2. Place GSL in N-DETENT, shutdown engine and remove key.
 3. Raise end of walking beam using a 2000 lb (908 kg) capacity jack or other suitable lifting device until the wheel is slightly off the ground.



4. Undo the six wheel bolts (E) and remove wheel from hub.
- b. Install the caster wheel as follows:
 1. Position wheel on hub and install wheel bolts (E).
 2. Torque bolts (E) to 120 ft·lbf (163 N·m) using the tightening sequence as shown on previous page.
 3. Lower windrower and remove jack.

57.10.2.6 Caster Wheels Anti-Shimmy Dampeners - Optional

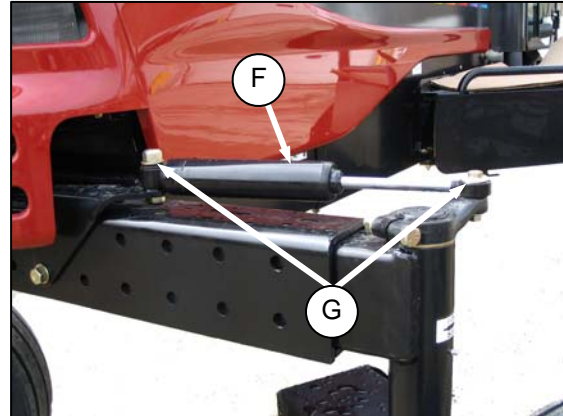

Each caster is equipped with a fluid filled anti-shimmy dampener (F). The mounting bolts (G) need to be checked periodically for security. Refer to Section 7.13, Maintenance Schedule. Inboard bolt should be tightened to 100 ft·lbf (135 N·m). Outboard bolt should be tightened to 85 ft·lbf (115 N·m).

MAINTENANCE/SERVICE

57.11 MAINTENANCE SCHEDULE

The maintenance schedule (see next page) specifies the periodic maintenance procedures and service intervals. Regular maintenance is the best insurance against early wear and untimely breakdowns. Following this schedule will increase machine life. For detailed instructions, refer to Sections 7.6 to 7.12. Use the fluids and lubricants specified in Section 7.3.1, Recommended Fuel, Fluids and Lubricants.

Service Intervals: The recommended service intervals are in hours of operation. Where a service interval is given in more than one time frame, e.g. "100 hours or Annually", service the machine at whichever interval is reached first.

IMPORTANT

Recommended intervals are for average conditions. Service the machine more often if operated under adverse conditions (severe dust, extra heavy loads, etc.).



CAUTION

Carefully follow safety messages given under Section 7.1 PREPARATION FOR SERVICING, and Section 7.2 RECOMMENDED SAFETY PROCEDURES.

57.11.1 Break-In Inspection

HRS	ITEM	CHECK	REF.
Every .25 Road or 1 in Field	Drive Wheel Nuts	Torque – 220 ft·lbf (300 N·m) Repeat Checks Until Torque Stabilizes.	7.12.1
5	A/C Belt	Tension	7.8.8.3
	Caster Wheel Nuts	Torque – 120 ft·lbf (163 N·m)	7.12.2
	Caster Wheel Anti-Shimmy Dampener Bolts (Optional)	Inboard Bolt Torque – 100 ft·lbf (135 N·m) Outboard Bolt Torque – 85 ft·lbf (115 N·m)	
	Walking Beam Width Adjustment Bolts (Optional)	Torque – 330 ft·lbf (448 N·m)	6.3.7
10	Walking Beam Width Adjustment Bolts (Optional)	Torque – 330 ft·lbf (448 N·m)	
	Drive Wheel Nuts	Torque – 220 ft·lbf (300 N·m)	7.12.1
	Neutral	Dealer Adjust	-
50	Hose Clamps – Air Intake/Radiator/Heater/Exhaust/ Hydraulic	Hand Tighten Unless Otherwise Noted.	7.8.4, 7.8.6, 7.8.7 & 7.3
	Walking Beam Width Adjustment Bolts (Optional)	Torque – 330 ft·lbf (448 N·m)	6.3.7
	Caster Wheel Anti-Shimmy Dampener Bolts (Optional)	Inboard Bolt Torque – 100 ft·lbf (135 N·m) Outboard Bolt Torque – 85 ft·lbf (115 N·m)	7.12.2
	Drive Wheel Nuts	Torque 220 ft·lbf (300 N·m)	7.12.1
	Drive Wheel Lubricant	Change	7.12.1.3
	Hydraulic Oil Filters	Change	7.11.4

MAINTENANCE/SERVICE

57.11.2 Interval Maintenance

INTERVAL	SERVICE
FIRST USE	Refer To Break-In Inspection On Previous Page.
ANNUALLY *	<ol style="list-style-type: none"> 1. Change Fuel Tank Vent Line Filter. 2. Check Battery Fluid Level. 3. Check Battery Charge. 4. Check Anti-Freeze Concentration. 5. Cycle A/C Blower Switch To Distribute Refrigerant Oil. 6. Check Safety Systems (or 500 hours whichever occurs first).
END OF SEASON	Refer To Section 6.3.9 Storage.
10 HOURS OR DAILY	<ol style="list-style-type: none"> 1. Check Tire Inflation. 2. Check Engine Oil Level. 3. Check Engine Coolant Level At Reserve Tank. 4. Clean Radiator, Hydraulic Oil Cooler, Charge Air Cooler, And A/C Condenser. 5. Check Hydraulic Oil Level. 6. Drain Fuel Filter Water Trap. 7. Fill Fuel Tank. 8. Check Hydraulic Hoses And Lines For Leaks.
50 HOURS	<ol style="list-style-type: none"> 1. Grease Caster Pivots. 2. Grease Walking Beam Center Pivot. 3. Grease Top Lift Link Pivots. 4. Grease Forked Caster Spindle Bearings. 5. Clean Cab Fresh Air Intake Filter.
100 HOURS OR ANNUALLY *	<ol style="list-style-type: none"> 1. Clean Cab Air Return Filter.
200 HOURS OR ANNUALLY *	<ol style="list-style-type: none"> 1. Check Drive Wheel Lubricant Level. 2. Grease Formed Caster Wheel Hub Bearings. 3. Check Wheel Nut Torque.
250 HOURS OR 3 MONTHS	<ol style="list-style-type: none"> 1. Change Engine Oil And Filter. 2. Change Engine Air Cleaner Primary Filter Element (CDM displays ENGINE AIR FILTER).
500 HOURS	<ol style="list-style-type: none"> 1. Change Fuel Filters. 2. Change Hydraulic Oil Filters. 3. Check Engine Valve Tappet Clearance.
1000 HOURS	<ol style="list-style-type: none"> 1. Change Drive Wheel Lubricant. 2. Check Engine Valve Tappet Clearance.
2000 HOURS	<ol style="list-style-type: none"> 1. Change Hydraulic Oil. 2. Perform General Engine Inspection. 3. Change Engine Coolant.
<p>* IT IS RECOMMENDED THAT ANNUAL MAINTENANCE BE DONE PRIOR TO START OF OPERATING SEASON.</p>	

MAINTENANCE/SERVICE

WINDROWER Serial No. _____

Combine this record with the record in the Header Operator's Manual.
Refer to Section 7, Maintenance/Service for details on each maintenance procedure.
Copy this page to continue record.

MAINTENANCE RECORD	ACTION:	✓ - Check	⬇ - Lubricate	▲ - Change	* - Clean	+ - Add															
	Hour Meter Reading																				
	Date																				
	Serviced By																				
FIRST USE		Refer to Section 7.13.1 Break-In Inspection																			
10 HOURS OR DAILY		NOTE: A RECORD OF DAILY MAINTENANCE IS NOT NORMALLY REQUIRED BUT IS AT THE OWNER/OPERATOR'S DISCRETION.																			
*	A/C Condenser																				
*	Charge Air Cooler																				
✓	Engine Oil Level																				
✓	Engine Coolant Level																				
✓	Fuel Tank																				
✓	Fuel Filter Water Trap																				
✓	Hydraulic Hoses And Lines																				
*	Hydraulic Oil Cooler																				
✓	Hydraulic Oil Level																				
*	Radiator																				
✓	Tire Inflation																				
ANNUALLY																					
✓	A/C Blower																				
✓	Anti-Freeze Concentration																				
✓	Battery Charge																				
✓	Battery Fluid Level																				
▲	Fuel Tank Vent Line Filter																				
✓	Safety Systems (or 500 hours)																				
50 HOURS																					
*	Cab Fresh Air Intake Filter																				
⬇	Caster Pivots																				
⬇	Forked Caster Spindle Bearings																				
⬇	Top Lift Link Pivots																				
⬇	Walking Beam Center Pivot																				
100 HOURS OR ANNUALLY																					
*	Cab Air Return Filter																				
200 HOURS OR ANNUALLY																					
⬇	Formed Caster Wheel Hub Bearings																				
✓	Drive Wheel Lubricant																				
✓	Wheel Nut Torque																				

Continued Next Page

MAINTENANCE/SERVICE

ACTION:		✓ - Check	⬇ - Lubricate	▲ - Change	* - Clean	+ - Add																
MAINTENANCE RECORD	Hour Meter Reading																					
	Date																					
	Serviced By																					
250 HOURS OR 3 MONTHS																						
▲	Engine Oil And Filter																					
▲	Engine Air Cleaner Primary Filter Element																					
500 HOURS																						
▲	Fuel Filters																					
✓	Engine Valve Tappet Clearance (1 st)																					
▲	Crankcase Breather																					
▲	Hydraulic Oil Filters																					
1000 HOURS																						
▲	Drive Wheel Lubricant																					
✓	Engine Valve Tappet Clearance																					
2000 HOURS																						
▲	Engine Coolant																					
✓	General Inspection																					
▲	Hydraulic Oil																					

TROUBLESHOOTING

58 TROUBLESHOOTING

58.1 ENGINE

SYMPTOM	PROBLEM	SOLUTION	SECTION
Engine Hard To Start Or Will Not Start.	Controls not in neutral.	Move GSL to neutral. Move steering wheel to locked position. Disengage header clutch.	6.3.5.1 6.3.5.1 5.16.1
	Neutral interlock misadjusted.	Contact MacDon dealer.	*
	No fuel to engine.	Fill empty fuel tank, replace clogged filter.	6.3.5.4 7.8.5.2
	Old fuel in tank.	Drain tank, refill with fresh fuel.	7.8.5.3
	Water, dirt or air in fuel system.	Drain, flush, fill and prime system.	7.8.5.3
	Improper type of fuel.	Use proper fuel for operating conditions.	7.3.1
	Crankcase oil too heavy.	Use recommended oil.	7.3.1
	Low battery output.	Have battery tested. Check battery electrolyte level.	7.10.1.4
	Poor battery connection.	Clean and tighten loose connections.	7.10.1.4
	Faulty starter.	Contact MacDon dealer.	*
	Wiring shorted, circuit breaker open.	Check continuity of wiring and breaker (manual reset).	7.10.8.1
	Loose connection at fuel pump.	Ensure connector at pump is fully pushed in.	-
	ECM fuse (1 of 2) blown. ECM Ignition relay faulty. Neutral Logic relay faulty.	Replace.	7.10.8.2
	Faulty injectors.	Contact MacDon dealer.	*
Engine Knocks.	Insufficient oil.	Add oil.	7.8.2
	Engine out of time.	Contact MacDon dealer.	*
	Low or high coolant temperature.	Remove and check thermostat. See "Engine Overheats".	**
	Improper fuel.	Use proper fuel.	7.3.1
Low Oil Pressure.	Low oil level.	Add oil.	7.8.2
	Improper type of oil.	Drain, fill crankcase with proper oil.	7.8.3
	Worn components.	Contact MacDon dealer.	*
High Oil Consumption.	Crankcase oil too light.	Use recommended oil.	7.3.1
	Oil leaks.	Check for leaks around gaskets, seals, and drain plugs.	7.8.3
	Internal parts worn.	Contact MacDon dealer.	*
Engine Runs Irregularly Or Stalls Frequently.	Unsteady fuel supply.	Change filter on fuel tank vent line. Replace clogged fuel filter.	7.8.5.1 7.8.5.2
	Water or dirt in fuel system.	Drain, flush, and fill system.	7.8.5.3
	Air in fuel system.	Contact MacDon dealer.	*
	Low coolant temperature.	Remove and check thermostat.	**
	Dirty or faulty injectors.	Contact MacDon dealer.	*

(continued next page)

* See your MacDon dealer

** Refer to Windrower Technical Manual

TROUBLESHOOTING

SYMPTOM	PROBLEM	SOLUTION	SECTION
Lack Of Power.	Incorrect timing.	Contact MacDon dealer.	*
	Engine oil viscosity too high.	Use recommended oil.	7.3.3
	Intake air restriction.	Service air cleaner.	7.8.4.1
	Clogged fuel filter.	Replace primary fuel filter and if necessary, replace secondary fuel filter.	7.8.5.2
	High back pressure.	Clean out muffler.	7.8.7
	Improper type of fuel.	Use proper fuel.	7.3.1
	High or low engine temperature.	Remove and check thermostat. See "Engine Overheats".	**
	Improper valve clearance. Faulty injectors.	Contact MacDon dealer. Contact MacDon dealer.	* *
Engine Temperature Below Normal.	Defective thermostat.	Remove and check thermostat.	*
Warning Alarm Sounds.	Engine overheated.	Check coolant level. Check thermostat.	7.8.6.1 **
	Low engine oil pressure.	Check oil level.	7.8.2
	Low transmission oil pressure.	Check oil level.	7.8.2
Engine Overheats.	Low coolant level.	Fill reserve tank to proper level. Check system for leaks.	7.8.6.1
	Engine overloaded.	Reduce ground speed.	6.3.6.2
	Defective radiator cap.	Replace cap.	7.8.6.2
	Defective fan belt.	Replace belt.	7.8.8.3
	Dirty radiator screen: • Rotors turning • Rotors not turning	Check for obstructions in ducting from screen to fan shroud. Check connections to rotor electric motor.	7.10.1
	Dirty radiator core.	Clean radiator.	7.10.2
	Cooling system dirty.	Flush cooling system.	7.8.6.3
	Defective thermostat.	Remove and check thermostat.	**
	Defective temperature gauge or sender.	Check coolant temperature with thermometer, replace if necessary.	7.8.6.2
	Defective water pump.	Contact MacDon dealer. Use antifreeze.	* 7.8.6.1
Engine RPM Cannot Exceed 2400.	ISC engaged.	Disengage ISC	5.18.5
High Fuel Consumption.	Improper type of fuel.	Use proper fuel.	7.3.1
	Clogged or dirty air cleaner.	Service air cleaner.	7.8.4.1
	Engine overloaded.	Reduce ground speed.	6.3.6.2
	Improper valve clearance.	Reset valves.	*
	Engine out of time.	Contact MacDon dealer.	*
	Low engine temperature.	Check thermostat.	**
Injection nozzles dirty.	Contact MacDon dealer.	*	

(continued next page)

* See your MacDon dealer

** Refer to Windrower Technical Manual

TROUBLESHOOTING

SYMPTOM	PROBLEM	SOLUTION	SECTION
Engine Emits Black Or Grey Exhaust.	Improper type of fuel.	Consult your fuel supplier and use proper type fuel for conditions.	7.3.1
	Engine overloaded.	Reduce ground speed.	6.3.6.2
	Clogged or dirty air cleaner.	Service air cleaner.	7.8.4.1
	Defective muffler.	Check muffler for possible damage which might create back pressure.	7.8.7
	Dirty or faulty injectors. Engine out of time. Air in fuel system.	Contact MacDon dealer.	*
Engine Emits White Exhaust.	Improper type of fuel.	Consult your fuel supplier and use proper type fuel for conditions.	7.3.1
	Cool engine.	Warm engine up to normal operating temperature.	6.3.5.2
	Defective thermostat.	Remove and check thermostat.	**
	Engine out of time.	Contact MacDon dealer.	*
Starter Cranks Slowly Or Will Not Operate.	Low battery output.	Check battery charge.	7.10.1.1
	Controls not in neutral.	Move GSL to neutral.	6.3.6
		Move steering wheel to center position.	6.3.5.1
		Disengage header clutch.	5.16.1
	Relay not functioning.	Check relay and wire connections.	7.10.8.1
	Loose or corroded battery connections.	Clean and tighten loose connections.	7.10.1.4
	Key switch worn or terminals loose.	Contact MacDon dealer.	*
	Crankcase oil too high viscosity.	Use recommended oil.	7.3.3
	Main fuse defective/blown.	Replace main fuse.	7.10.8
	Key power fuse blown.	Replace.	7.10.8
Switch at interlock not closed or defective.	Adjust switch or replace.	*	
Air Filters Require Frequent Cleaning.	Vacuator plugged.	Clean out vacuator.	7.8.4.1
	Pre-cleaner rotor not turning freely.	Repair/replace.	7.10.1

58.2 ELECTRICAL

SYMPTOM	PROBLEM	SOLUTION	SECTION
Low Voltage And/Or Battery Will Not Charge.	Defective battery.	Have battery tested.	7.10.1.4
	Defective alternator belt.	Replace worn belt.	7.8.8.2
	Loose or corroded connections.	Clean and tighten battery connections.	7.10.1.4
	Dirty or defective alternator, defective voltage regulator, or high resistance in circuit.	Contact MacDon dealer.	*
	Alternator or voltage regulator not connected properly.	Connect properly.	7.10.1.6

(continued next page)

* See your MacDon dealer

** Refer to Windrower Technical Manual

TROUBLESHOOTING

SYMPTOM	PROBLEM	SOLUTION	SECTION
Lights Dim.	High resistance in circuit or poor ground on lights.	Check the wiring circuit for a break in a wire or a poor ground.	---
	Defective light switch.	Contact MacDon dealer.	*
Lights Do Not Light.	Burnt out light bulb.	Replace light bulb.	7.10.2 to 7.10.9
	Defective light switch.	Contact MacDon dealer.	*
	Broken wiring.	Check wiring for broken wire or shorts.	---
	Open or defective circuit breaker.	Check circuit breaker.	7.10.8.1
	Defective relay.	Replace relay.	---
Turn Signals Or Indicators Showing Wrong Direction.	Poor ground on lights.	Clean and tighten ground wires.	---
	Reversed wires.	Contact MacDon dealer.	*
No Current To Cab.	Circuit breaker tripped.	Breaker automatically resets.	---
	Broken or disconnected wire.	Contact MacDon dealer.	*

58.3 HYDRAULICS

SYMPTOM	PROBLEM	SOLUTION	SECTION
Header Or Reel Not Lifting.	Contaminant in relief valve.	Clean relief valve at cylinder control valve.	**
	Appropriate solenoids not being energized by activating switch.	Contact MacDon dealer.	*
Header Or Reel Lifts But Lacks Power.	Relief pressure too low or contaminant in relief valve.	Check/adjust/clean relief valve at cylinder control valve.	**
Reel And/Or Conveyor Not Turning.	Header drive switch not engaged.	Engage switch.	5.16.1
	Flow controls adjusted too low.	Toggle speed controls on CDM to increase flow.	6.5.3, 6.5.4, 6.6.4
	Appropriate solenoid on flow control block not being energized.	Contact MacDon dealer.	*
Reel And/Or Conveyor Turns But Lacks Power.	Relief pressure too low.	Check/adjust/clean compensator pump.	**

58.4 HEADER DRIVE

SYMPTOM	PROBLEM	SOLUTION	SECTION
Sickle Drive Not Engaging.	Header drive switch in cab not engaged.	Engage switch.	5.16.1
	Appropriate solenoid not being energized by activating switch.	Contact MacDon dealer.	*
	Operator presence switch not closed or faulty.	Occupy operator's seat or replace switch.	*
Sickle Drive Lacks Power	Header drive overload.	Reduce ground speed.	6.3.6.2
	Pressure too low or contaminant in pump compensator valve.	Check/adjust/clean compensator valve on knife drive pump.	*
Warning Alarm Sounds	Header drive overload.	Reduce ground speed.	6.3.6.2
	Compensator valve setting too low.	Adjust compensator valve on knife drive pump.	*

* See your MacDon dealer

** Refer to Windrower Technical Manual

TROUBLESHOOTING

58.5 TRACTION DRIVE

SYMPTOM	PROBLEM	SOLUTION	SECTION
Warning Alarm Sounds And Transmission Oil Light Is On.	Low hydraulic oil level.	Stop engine and add oil to hydraulic system.	7.12.1
	Low hydraulic pressure.	Contact MacDon dealer.	*
	Foreign material shorting sender.		
	Short in alarm wiring.		
	Faulty sender.		
Wheels Lack Pulling Ability On A Grade Or Pulling Out Of A Ditch.	Insufficient torque at drive wheels.	Move speed-range control to field position and reduce ground speed.	6.3.6
	Loose or worn controls.	Check controls.	7.8.3
	Air in system.	Use proper oil.	7.3.3
		Check oil level, and leaks.	7.11.1
		Check oil filters.	7.11.4
	Brakes binding or not releasing fully.	Check pressure (min. 200 psi (1379 kPa)) on brake release valve.	**
Internal pump or motor damage.	Contact MacDon dealer.	*	
Relief valve in tandem pump dirty or damaged.	Replace relief valve.	**	
Both Wheels Will Not Pull In Forward Or Reverse.	Low oil level.	Check oil reservoir level.	7.11.1
	Power hubs disengaged.	Engage power hubs.	6.3.8.4
	Damaged hydraulic lines preventing proper oil flow.	Replace damaged lines.	*
	Steering controls worn or defective.	Check GSL and steering for loose, worn or damaged ball joints and connecting rods.	7.7.3 & 7.7.4
	Speed-range control not working.	Contact MacDon dealer.	*
	Pump arms have broken shaft or loose hardware.	Repair or tighten.	**
	Brakes binding or not releasing fully.	Check pressure (min. 200 psi (1379 kPa)) on brake release valve.	**
	Charge pressure relief valve misadjusted or damaged.	Check the valve adjustment. Check valve parts and seat.	7.11.6.2
Failed pump or motor.	Contact MacDon dealer.	*	
One Wheel Does Not Pull In Forward Or Reverse.	One final drive disengaged.	Engage final drive.	6.3.8.3
	Pump arm or shaft are broken.	Contact MacDon dealer.	*
	Steering controls worn or defective.	Check GSL and steering for loose, worn or damaged ball joints and connecting rods.	7.7.3 & 7.7.4
	Damaged hydraulic lines preventing proper oil flow.	Contact MacDon dealer.	*
	Brakes binding or not releasing fully.	Check pressure (min. 200 psi on brake release valve).	**
	Speed-range control not working.	Contact MacDon dealer.	*

(continued next page)

* See your MacDon dealer

** Refer to Windrower Technical Manual

TROUBLESHOOTING

SYMPTOM	PROBLEM	SOLUTION	SECTION
One Wheel Does Not Pull In Forward Or Reverse (Continued).	High pressure relief valve stuck open, damaged seat.	Check valve and clean or replace.	**
	Failed pump, motor or power hub.	Contact MacDon dealer.	*
With Steering Wheel Centered, One Wheel Pulls More Than The Other.	Leakage at pump or motor.	Contact MacDon dealer.	*
	Wheels not in same speed range.	Repair or replace valve.	7.11.6.2
	Faulty relief valve.		
Excessive Noise From Drive System.	Hydraulic line clamps loose.	Tighten clamps.	---
	Mechanical interference in steering or ground speed linkage.	Adjust, repair, replace.	7.7.3 & 7.7.4
	Brakes binding or not releasing fully.	Check pressure (min. 200 psi on brake release valve).	**
	Faulty pump or motor.	Contact MacDon dealer.	*
	Air in system.	Check lines for leakage.	---
Hydraulic Oil Filter Leaks At Seal.	Not properly tightened.	Tighten filter element.	7.11.4
	Damaged seal or threads.	Replace filter or filter head.	7.11.4

58.6 STEERING AND GROUND SPEED CONTROL

SYMPTOM	PROBLEM	SOLUTION	SECTION
Machine Will Not Steer Straight.	Linkage worn or loose.	Adjust steering chain tension. Replace worn parts, adjust linkage.	7.7.4.2 7.7.4.1
Machine Moves On Flat Ground With Controls In Neutral.	Neutral interlock misadjusted. Parking brake not functioning.	Contact MacDon dealer.	*
Insufficient Road Speed.	Speed-range control in field position.	Move to road position.	6.3.8.1
Steering Wheel Will Not Lock With GSL In N-DETENT.	Transmission interlock misadjusted.	Contact MacDon dealer.	*

* See your MacDon dealer

** Refer to Windrower Technical Manual

TROUBLESHOOTING

58.7 CAB AIR

SYMPTOM	PROBLEM	SOLUTION	SECTION
Blower Fan Will Not Run.	Burned out motor. Burned out switch. Motor shaft tight or bearings worn. Faulty wiring - loose or broken. Blower rotors in contact with housing.	Contact MacDon dealer.	*
Blower Fan Operating But No Air Coming Into Cab.	Dirty fresh air filter. Dirty recirculating air. Evaporator clogged. Air flow passage blocked.	Clean filter. Clean filter. Clean evaporator. Remove blockage.	7.7.5.1 7.7.5.2 7.7.5.4 ---
Heater Not Heating.	Heater shut-off valve at engine closed. Defective thermostat in engine water outlet manifold. Heater temperature control defective. No thermostat in engine water outlet manifold.	Open valve. Replace thermostat. Replace control. Install thermostat.	5.10.1.1 ** ** **
Odour From Air Louvers.	Plugged drainage hose. Dirty filters.	Blow out hose with compressed air. Clean filters.	--- 7.7.5.1 & 7.7.5.2
Air Conditioning Not Cooling.	Low refrigerant level. Switch contacts in thermostat burned excessively, or sensing element defective. Clutch coil burned out or disconnected. Condenser fins plugged. Blower motor disconnected or burned out. Loose or broken drive belt. Compressor partially or completely seized. Dirty filters. Broken or disconnected electrical wire. Broken or disconnected ground wire. Expansion valve stuck in open or closed position. Broken refrigerant line. Leak in system.	Add refrigerant Replace thermostat. Contact MacDon dealer. Clean condenser. Contact MacDon dealer. Replace drive belt and/ or tighten to specs. Remove compressor for service or replacement. Clean fresh air and re-circulation filters. Check all terminals for loose connections; check wiring for hidden breaks. Check ground wire to see if loose, broken, or disconnected. Contact MacDon dealer.	* ** * 7.9.2 * 7.8.8.4 ** 7.7.5.1 & 7.7.5.2 --- --- *

(continued next page)

* See your MacDon dealer

** Refer to Windrower Technical Manual

TROUBLESHOOTING

SYMPTOM	PROBLEM	SOLUTION	SECTION
Air Conditioning Not Cooling. (Continued)	Compressor shaft seal leaking.	Contact MacDon dealer.	*
	Clogged screen in receiver-drier; plugged hose or coil.		
Air Conditioning Not Producing Sufficient Cooling. (Sufficient Cooling Defined As When Air Temperature In Cab, Measured At Louvered Vent, Can Be Maintained At 25°F (14°C) Below Ambient Air Temperature.)	Compressor clutch slipping.	Remove clutch assembly for service or replacement.	**
	Clogged air filters.	Remove air filters and clean or replace as necessary.	7.7.5.1 & 7.7.5.2
	Heater circuit is open.	Close heater valves (1 in cab, 1 at engine).	5.10.1.1
	Too little air circulation over condenser coil; fins clogged with dirt or insects.	Clean condenser.	7.9.7.3
	Evaporator fins clogged.	Clean evaporator fins (under cab floor).	7.7.5.4
	Too little refrigerant in system.	Contact MacDon dealer.	*
	Clogged expansion valve.		
	Clogged receiver-drier.		
	Excessive moisture in system.	Replace thermostat.	**
	Air in system.		
Thermostat defective or improperly adjusted.	Contact MacDon dealer.	*	
Blower motor sluggish in operation.	Contact MacDon dealer.	*	
Air Conditioning System Too Noisy.	Defective winding or improper connection in compressor clutch coil or relay.	Contact MacDon dealer.	*
	Loose or excessively worn drive belt.	Tighten or replace as required.	7.8.8.4
	Noisy clutch.	Remove clutch for service or replacement as required.	**
	Noisy compressor.	Check mountings and repair. Remove compressor for service or replacement.	**
	Compressor oil level low.	Add SP-15 PAG refrigerant oil.	**
	Blower fan noisy due to excessive wear.	Remove blower motor for service or replacement as necessary.	**
	Excessive charge in system.	Contact MacDon dealer.	*
	Low charge in system.	Contact MacDon dealer.	*
	Excessive moisture in system.		

(continued next page)

* See your MacDon dealer

** Refer to Windrower Technical Manual

TROUBLESHOOTING

SYMPTOM	PROBLEM	SOLUTION	SECTION
Air Conditioning Cools Intermittently.	Compressor clutch slipping.	Contact MacDon dealer.	*
	Unit icing up due to: <ul style="list-style-type: none"> • Thermostat adjusted too low. • Excessive moisture in system. • Incorrect super-heat adjustment in expansion valve. 	Adjust thermostat.	**
	Thermostat defective. Defective blower switch or blower motor. Partially open, improper ground or loose connection in compressor clutch coil.	Contact MacDon dealer.	*
Windows Fog Up.	High humidity.	Run A/C to dehumidify air and heater to control temperature.	5.10.1.1

58.8 OPERATOR'S STATION

SYMPTOM	PROBLEM	SOLUTION	SECTION
Rough Ride.	Seat suspension not adjusted for operator's weight.	Adjust seat suspension.	5.3
	High air pressure in tires.	Deflate to proper pressure.	7.12.1 & 7.12.2

* See your MacDon dealer

** Refer to Windrower Technical Manual

OPTIONS

59 OPTIONS

59.1 REEL DRIVE & LIFT PLUMBING

Reel drive and lift plumbing for draper headers on windrowers that are shipped from the factory in auger header configuration. Installation instructions are included.

59.2 WINDROWER HYDRAULIC COMPLETION FOR DRAPER HEADER REEL FORE/AFT

Allows reel fore/aft hydraulic adjustment for draper headers on windrowers that are shipped from the factory in auger header configuration. Kit includes valve for selection of reel fore/aft or double windrow attachment functions. Installation instructions are included.

59.3 BOOSTER SPRING KIT

Available for headers over 6000 lb (2724 kg). Installation instructions are included.

59.4 INTERNAL BOOSTER SPRING KIT

Internal spring for right side lift linkage to improve float capacity. Standard equipment on left side. Installation instructions are included.

59.5 LIGHT HEADER FLOTATION KIT

Available for headers that do not require as much spring tension for float. Installation instructions are included.

59.6 AM-FM RADIO

Available for installation into pre-wired cab. Speakers are factory installed.

Refer to M100 Self-Propelled Windrower Unloading and Assembly Instructions supplied with your windrower for installation details.

59.7 HYDRAULIC CENTER LINK

The hydraulic center link allows the operator to adjust the header angle from the cab. Installation instructions are included.

59.8 FAN AIR BAFFLE KIT

Provides a baffle to reduce windrow disturbance by air exiting the engine cooling fan.

59.9 TRAINING SEAT

A wall mounted fold-up training seat complete with seat belt is available to assist in training a new operator. Installation instructions are included.

59.10 KNIFE SPEED, REEL SPEED INDEX, AND TILT SENSOR MODULE

To allow the electronic monitoring of header knife speed, reel speed and header angle. Also enables the indexing of reel speed to ground speed. Installation instructions are included.

59.11 ANTI-SHIMMY KIT FOR CASTERS

Prevents caster wheel shimmy when traveling at road speed.

59.12 SWATH ROLLER

If a swath roller is desired for canola or other similar crops, an axle mounted design is recommended. Windrower can be fitted with hydraulic lift version of swath rollers featuring in console controls.

59.13 WARNING BEACONS

Two roof mounted rotating warning beacons are available for installation into pre-wired cab. The beacons are standard equipment for export windrowers and optional for North America. Installation instructions are included.

59.14 AUTO-STEER

A MacDon approved auto-steer system is available for your windrower. Contact your dealer for further information.

Cabs have been prepared with "access routing knock outs" to enable easy wiring harness installation and display mounting. The GSL has been pre-wired with an auto-steer engage switch.

59.15 ENGINE BLOCK HEATER

Contact your nearest Cummins Engine Distributor and provide your engine model and serial numbers to ensure the proper heater is supplied.

(continued next page)

OPTIONS

59.16 TRANSPORT DRAWBAR

Allows an M100 Windrower to tow MacDon headers equipped with a Slow Speed Transport system. Includes drawbar, related parts, and installation instructions.

INDEX

Abbreviations.....	12	detaching.....	80
Air Cleaner	120	draper speed	85
Air Conditioning		knife speed	87, 96
compressor protection	23, 117	reel speed.....	83
condenser.....	116, 136	Drawbar.....	63
controls	22	swath roller	65
evaporator	116	Drive Wheels.....	159
operation.....	117	bolt torque	159
troubleshooting	176	lubricant.....	160
Alternator.....	142	removal/installation.....	161
Anti-freeze	99	Driving	
Attachments	179	roads	58
Auger Header		spin turn.....	56
attachment.....	89	stopping.....	56
auger speed.....	94	windrower	53
detaching.....	92	Electrical System	
reel speed.....	95	circuit breakers	149
Auxiliary Power.....	23	fuses.....	149
Ballast		main fuses	151
caster wheels.....	163	troubleshooting.....	172
Battery.....	138	Engine	
adding electrolyte	140	air filters	120
boosting	139	alternate speeds	52, 133
charging.....	139	battery	138
maintenance	138	battery maintenance	138
replacement.....	141	belt replacement.....	133
Belts		belt tension	132
compressor.....	133	break-in	47
fan	132	changing oil	119
Break-In Period	47	charge air	122
Cab		exhaust.....	131
air vents	22	fan belt.....	132
ingress/egress	54	fuel.....	See Fuel System
interior lighting	23	inspection	118
operator amenities	23	monitoring.....	30
radio.....	24	oil level	118
Cab Air Filters		oil pressure	52
servicing	115, 116	operating temperature	51
Cab Display Module	30, 31	operation	49
Cab Forward.....	55	speed adjustment	133
Cab Temperature	22	starting.....	49
Capacities.....	99	throttle adjustment.....	133
Caster Wheels.....	162	troubleshooting.....	170
anti-shimmy	165	voltage.....	52
ballast	163	warm-up	50
bolt torque.....	164	warning lights	36, 52
removal/installation.....	164, 165	Engine Cooling System.....	128
tread adjustment.....	57	changing coolant	129
CDM	30	coolant level & concentration.....	128
CDM Displays.....	31	cooling box servicing	136
Circuit Breakers	149	radiator screen.....	134
Compressor Oil	99	Engine Electrical System	
Console	16	damage prevention.....	142
Cooler.....	23	Engine Hood	103
Daily check.....	48	Engine Lock-out	
Deck Shift Switch	29	checks	107
Dimensions.....	13	Error Codes	185
Display		Exhaust	131
set-up.....	42	Fan Belt	
Display Warnings	37	replacement.....	132
Draper Header		tension.....	132
attachment.....	77	Field Lights.....	143
deck shift	88	Final Drive	68

INDEX

Float	70	valve block	155
Float Adjustment	70	Hydraulics	
Flood Lights	144, 145	hoses and lines	158
Fuel	99	leaks	158
Fuel System		Ignition Switch	25
filters	124	Interior Lights	148
priming	127	Jacking	161
separator	126	Knife Drive	
supply valve	125	valve block	155
tank venting	123	Knife Speed	
Fuel Tank		draper header	96
draining	125	Levelling the Header	72
Fueling	51	Lift Cylinder Stops	69
Fuses	149	Lighting	
Gauges	25	engine forward	20
Ground Speed		road	58
control lever	26	Lights	19
range switch	26	floodlight bulb replace	144
GSL		headlight adjustment	143
fore/aft	108	headlight bulb	143
position	110	rear flood	145
GVW		red tail	147
allowables	60	swath	146
Hazard Warning Lights	26	Lubricants	99
Header		Lubrication	105
angle adjustment	74	Maintenance Platforms	104
attaching draper	77	Maintenance Record	168
detaching draper	80	Maintenance Schedule	166
drive	73	Manual Storage	23
drop rate	156	Monitoring System	31
engage	73	Neutral Set-Up	113
float adjustment	70	Neutral Start Switch	111
float switch	29	Oil Cooler	136
flotation	70	Oil Filter	119
functions	30	Operating Screens	31
height control	75	Operator's Console	16
levelling	72	Operator's Presence	18
lift cylinder stops	69	checks	107
monitoring	30	engine	18
on/off switch	27	header drive	18
operation	69	transmission	18
position switch	28	Operator's Station	16
programming	39	troubleshooting	178
return to cut	75	Options	179
reverse	73	Owner/Operator Responsibilities	45
stand	79	Pre-Season Check	48
troubleshooting	173	Programming	39
Header Control Switches	27, 29	Radiator Cap	129
Header Controls	27	Radio	24
Heater		Rear View Mirrors	21
controls	22	Reel	
shut-off valve	22	position switch	28
Height Control	75	speed switch	28
Hub Locks	68	Refrigerant	99
Hydraulic System	152	Relief Valve	157
charge pump pressure	157	Return to Cut	75
oil changing	154	Rotors	
oil cooler	154	screen cleaners	134
oil filter	154	Safety	
oil level	152	general	10
relief pressure	155	operation	47
traction drive	157	procedures	98
transmission oil pressure	157	signal words	5
troubleshooting	173	signs	5

INDEX

symbols	5	hub locks	68
Seat Adjustment	16	neutral interlock	108
Seat Belts	17	neutral lock	111
maintenance	107	neutral set-up procedure	113
Serial Number	1	troubleshooting	174, 175
Servicing		Training Seat	17
preparation	98	Transport Mode	61
Signal Lights	148	Transporting	58
Specifications	13, 14	Troubleshooting	
Starting Engine	49	air conditioning	176
Steering Column Adjust	17	electrical	172
Storage		engine	170
fuel and lubricants	99	header drive	173
windrower	68	hydraulics	173
Swath Lights	146	operator's Station	178
Symbol Definitions	45	traction drive	174
Tail Lights	147	Turn Signals	26
Tire Inflation		Warnings	
caster wheels	162	engine	36
drive wheels	159	Water In Fuel Sensor	120
Torques	100	WCM	31
Tow-Bar		Weight Box	62
attachment	63	Wheel Bolt Torque	159, 164
Towing		Windrower	
electrical	64	break-in	48
header	60	dimensions	13
Towing Windrower	67	driving	53
Traction drive		driving on road	58
neutral start switch	111	electrical	See Electrical System
Traction Drive		monitoring	30
adjustments	108	specifications	14
cable tension	110	towing	67
GSL fore/aft	108	transporting	58
GSL position	110	Windshield Wipers	21

ENGINE ERROR CODES

Example: CDM displays the Error Code **110S 16F 28C**

STEP 1. **110S** – **S** is **SPN** column, then locate code **110** in that column.

STEP 2. **16F** – **F** is the **FMI** column, then locate code **16** in that column.

STEP 3. **28C** – **C** is occurrences, **28** is the quantity.

STEP 4. **DESCRIPTION** - Coolant Temperature High - Data Valid but above Normal Operational Range - Moderately Severe Level Engine Coolant Temp.

STEP 5. Refer to **LAMP COLOR** and specific **CUMMINS ENGINE CODES** as required.

J1939 SPN Description	J1939 SPN	J1939 FMI	Lamp Color	Cummins Engine Code	Cat Engine Code	Cummins / Caterpillar Description
Crankcase Pressure	22	3	Amber	719		Extended Crankcase Blow-by Pressure Circuit - Voltage Above Normal, or Shorted to High Source
		4	Amber	729		Extended Crankcase Blow-by Pressure Circuit - Voltage Below Normal, or Shorted to Low Source
Coolant Temperature	32	3	Amber	2111		Coolant Temperature 2 Sensor Circuit - Voltage Above Normal, or Shorted to High Source
		0	Red	2114		Coolant Temperature 2 - Data Valid but Above Normal Operational Range - Most Severe Level
	52	4	Amber	2112		Coolant Temperature 2 Sensor Circuit - Voltage Below Normal, or Shorted to Low Source
		16	Amber	2113		Coolant Temperature 2 - Data Valid but Above Normal Operational Range - Moderately Severe Level
Accelerator Pedal Position	91	0	Red	148		Accelerator Pedal or Lever Position Sensor Circuit – Abnormal Frequency, Pulse Width, or Period
		1	Red	147		Accelerator Pedal or Lever Position Sensor Circuit – Abnormal Frequency, Pulse Width, or Period
		2	Red	1242	91	Accelerator Pedal or Lever Position Sensor 1 and 2 - Data Erratic, Intermittent, or Incorrect
		3	Red	131	91	Accelerator Pedal or Lever Position Sensor Circuit - Voltage Above Normal, or Shorted to High Source
		4	Red	132	91	Accelerator Pedal or Lever Position Sensor Circuit - Voltage Below Normal, or Shorted to Low Source
		8	154		91	Abnormal frequency, pulse width, or period
		12	154		91	Bad Device or component
		19	Red	287		SAE J1939 Multiplexing Accelerator Pedal or Lever Sensor System Error - Received Network Data In Error
Fuel Delivery Pressure	94	1	Amber	2216		Fuel Pump Delivery Pressure - Data Valid but Above Normal Operational Range – Moderately Severe Level
		2	Amber	268		Fuel Pressure Sensor Circuit - Data Erratic, Intermittent, or Incorrect
		3	Amber	546		Fuel Delivery Pressure Sensor Circuit - Voltage Above Normal or Shorted to High Source
		4	Amber	547		Fuel Delivery Pressure Sensor Circuit - Voltage Below Normal or Shorted to Low Source
		15	Maint	2261		Fuel Pump Delivery Pressure – Data Valid but Above Normal Operational Range - Least Severe Level
		17	Maint	2262		Fuel Pump Delivery Pressure – Data Valid but Below Normal Operational Range - Least Severe Level
		18	Amber	2215		Fuel Pump Delivery Pressure - Data Valid but Below Normal Operational Range - Moderately Severe Level
Engine Fuel Filter Differential Pressure	95	16	Amber	2372		Engine Fuel Filter Differential Pressure - Data Valid but Above Normal Operational Range - Moderately Severe level
Water in Fuel Indicator	97	3	Amber	428		Water in Fuel Sensor Circuit - Voltage Above Normal, or Shorted to High Source
		4	Amber	429		Water in Fuel Sensor Circuit - Voltage Below Normal, or Shorted to Low Source
		15	Maint	418		Water in Fuel Indicator High - Data Valid but Above Normal Operational Range – Least Severe Level
		16	Amber	1852		Water in Fuel Indicator - Data Valid but Above Normal Operational Range - Moderately Severe Level

ENGINE ERROR CODES

J1939 SPN Description	J1939 SPN	J1939 FMI	Lamp Color	Cummins Engine Code	Cat Engine Code	Cummins / Caterpillar Description
Engine Oil Pressure	100	1	Red	415	360	Oil Pressure Low – Data Valid but Below Normal Operational Range - Most Severe Level
		2	Amber	435		Oil Pressure Sensor Circuit - Data Erratic, Intermittent, or Incorrect
		3	Amber	135	100	Oil Pressure Sensor Circuit - Voltage Above Normal, or Shorted to High Source
		4	Amber	141	100	Oil Pressure Sensor Circuit - Voltage Below Normal, or Shorted to Low Source
		10	157		100	Engine oil pressure sensor 5V supply connection open circuit
		17	N/A		360	Low oil pressure - WARNING
		18	Amber	143	360	Oil Pressure Low – Data Valid but Below Normal Operational Range - Moderately Severe Level
Boost Pressure	102	2	Amber	433		Intake Manifold Pressure Sensor Circuit - Data Erratic, Intermittent, or Incorrect
		3	Amber	122		Intake Manifold Pressure Sensor Circuit – Voltage Above Normal, or Shorted to High Source
		4	Amber	123		Intake Manifold Pressure Sensor Circuit – Voltage Below Normal, or Shorted to Low Source
		16	Amber	124		Intake Manifold 1 Pressure Data Valid but Above Normal – Operational Range - Moderately Severe Level
Turbocharger 1 Speed	103	10	Amber	2345		Turbocharger speed invalid rate of change detected - Abnormal Rate of Change
		16	Amber	595		Turbocharger #1 Speed High - Data Valid but Above Normal Operational Range – Moderately Severe Level
		18	Amber	687		Turbocharger #1 Speed Low - Data Valid but Below Normal Operational Range – Moderately Severe Level
Intake Manifold #1 Temp	105	0	Red	155		Intake Manifold Air Temperature High – Data Valid but Above Normal Operational Range - Most Severe Level
		3	Amber	153	172	Intake Manifold Air Temperature Sensor Circuit - Voltage Above Normal, or Shorted to High Source
		4	Amber	154	172	Intake Manifold Air Temperature Sensor Circuit - Voltage Below Normal, or Shorted to Low Source
		15	None	2964	539	Intake Manifold Temperature High - Data Valid but Above Normal Operational Range - Least Severe Level
		16	Amber	488	539	Intake Manifold 1 Temperature - Data Valid but Above Normal Operational Range - Moderately Severe Level
Inlet Manifold Pressure Sensor	106	3	135		1785	Voltage above normal or shorted high
		4	135		1785	Voltage below normal or shorted low
		10	135		1785	Inlet Manifold Pressure Sensor 5V supply connection open circuit
Barometric Pressure	108	2	Amber	295		Barometric Pressure Sensor Circuit - Data Erratic, Intermittent, or Incorrect
		3	Amber	221		Barometric Pressure Sensor Circuit – Voltage Above Normal, or Shorted to High Source
		4	Amber	222		Barometric Pressure Sensor Circuit – Voltage Below Normal, or Shorted to Low Source
Coolant Pressure	109	3	Amber	231		Coolant Pressure Sensor Circuit - Voltage Above Normal, or Shorted to High Source
		4	Amber	232		Coolant Pressure Sensor Circuit - Voltage Below Normal, or Shorted to Low Source
		18	Amber	233		Coolant Pressure - Data Valid but Below Normal Operational Range - Moderately Severe Level
Engine Coolant Temperature	110	0	Red	151	361	Coolant Temperature Low - Data Valid but Above Normal Operational Range - Most Severe Level
		2	Amber	334		Coolant Temperature Sensor Circuit – Data Erratic, Intermittent, or Incorrect
		3	Amber	144	110	Coolant Temperature Sensor Circuit – Voltage Above Normal, or Shorted to High Source
		4	Amber	145	110	Coolant Temperature Sensor Circuit – Voltage Below Normal, or Shorted to Low Source
		15	None	2963	361	Engine Coolant Temperature High - Data Valid but Above Normal Operational Range - Least Severe Level
		16	Amber	146	361	Coolant Temperature High - Data Valid but Above Normal Operational Range - Moderately Severe Level

ENGINE ERROR CODES

J1939 SPN Description	J1939 SPN	J1939 FMI	Lamp Color	Cummins Engine Code	Cat Engine Code	Cummins / Caterpillar Description
Injector Metering Rail 1 Pressure	157	0	Red	449		Fuel Pressure High - Data Valid but Above Normal Operational Range - Moderately Severe Level
		1	Amber	2249		Injector Metering Rail 1 Pressure - Data Valid but Below Normal Operational Range - Most Severe Level
		2	Amber	554		Fuel Pressure Sensor Error - Data Erratic, Intermittent, or Incorrect
		3	Amber	451	1797	Injector Metering Rail #1 Pressure Sensor Circuit - Voltage Above Normal, or Shorted to High Source
		4	Amber	452	1797	Injector Metering Rail #1 Pressure Sensor Circuit - Voltage Below Normal, or Shorted to Low Source
		16	Amber	553		Injector Metering Rail #1 Pressure High - Data Valid but Above Normal Operational Range - Moderately Severe Level
		18	Amber	559		Injector Metering Rail #1 Pressure Low - Data Valid but Below Normal Operational Range - Moderately Severe Level
Key Switch	158	2	439		1834	Data erratic, intermittent, or incorrect
Cylinder Power	166	2	None	951		Cylinder Power Imbalance Between Cylinders - Data Erratic, Intermittent, or Incorrect
Alternator Potential (voltage)	167	1	Red	598		Electrical Charging System Voltage Low - Data Valid but Below Normal Operational Range - Most Severe Level
		16	Amber	596		Electrical Charging System Voltage High - Data Valid but Above Normal Operational Range - Moderately Severe Level
		18	Amber	597		Electrical Charging System Voltage Low - Data Valid but Below Normal Operational Range - Moderately Severe Level
ECM battery power	168	0			168	Excessive battery power
		1	422		168	Low battery power
		2			168	Intermittent
		16	Amber	442		Battery #1 Voltage High - Data Valid but Above Normal Operational Range - Moderately Severe Level
		18	Amber	441		Battery #1 Voltage Low - Data Valid but Below Normal Operational Range - Moderately Severe Level
Ambient Air Temperature	171	3	Amber	249		Ambient Air Temperature Sensor Circuit - Voltage Above Normal, or Shorted to High Source
		4	Amber	256		Ambient Air Temperature Sensor Circuit - Voltage Below Normal, or Shorted to Low Source
Fuel Temperature	174	3	Amber	263		Engine Fuel Temperature Sensor 1 Circuit - Voltage Above Normal, or Shorted to High Source
		4	Amber	265		Engine Fuel Temperature Sensor 1 Circuit - Voltage Below Normal, or Shorted to Low Source
		16	Amber	261		Engine Fuel Temperature - Data Valid but Above Normal Operational Range - Moderately Severe Level
Oil Temperature	175	0	Red	214		Engine Oil Temperature - Data Valid but Above Normal Operational Range - Most Severe Level
		2	Amber	425		Engine Oil Temperature -Data Erratic, Intermittent, or Incorrect
		3	Amber	212		Engine Oil Temperature Sensor 1 Circuit - Voltage Above Normal, or Shorted to High Source
		4	Amber	213		Engine Oil Temperature Sensor 1 Circuit - Voltage Below Normal, or Shorted to Low Source
Engine Speed	190	0	Red	234		Engine Speed High - Data Valid but Above Normal Operational Range - Most Severe Level
		2	Amber	689		Primary Engine Speed Sensor Error - Data Erratic, Intermittent, or Incorrect
		8	141		190	Abnormal signal frequency
		15	N/A		362	Engine Overspeed - WARNING
Real Time Clock Power	251	2	Maint	319		Real Time Clock Power Interrupt - Data Erratic, Intermittent, or Incorrect
Exhaust Gas Recirculation Temperature	412	3	Amber	2375		Exhaust Gas Recirculation Temperature Sensor Circuit - Voltage Above Normal, or Shorted to High Source
		4	Amber	2376		Exhaust Gas Recirculation Temperature Sensor Circuit - Voltage Below Normal, or Shorted to Low Source
OEM Temperature #1	441	3	Amber	293		Auxiliary Temperature Sensor Input # 1 Circuit -Voltage Above Normal, or Shorted to High Source
		4	Amber	294		Auxiliary Temperature Sensor Input # 1 Circuit -Voltage Below Normal, or Shorted to Low Source

ENGINE ERROR CODES

J1939 SPN Description	J1939 SPN	J1939 FMI	Lamp Color	Cummins Engine Code	Cat Engine Code	Cummins / Caterpillar Description
		14	Red	292		Auxiliary Temperature Sensor Input # 1 Circuit - Special Instructions
Accelerator Pedal Low Idle Switch	558	2	Amber	431	91	Accelerator Pedal or Lever Idle Validation Circuit - Data Erratic, Intermittent, or Incorrect
		2	155		774	Data erratic, intermittent, or incorrect
		4	Amber	551		Accelerator Pedal or Lever Idle Validation Circuit - Voltage Below Normal, or Shorted to Low Source
		13	Red	432		Accelerator Pedal or Lever Idle Validation Circuit - Out of Calibration
System Diagnostic code # 1		3	Amber	2185		Sensor Supply Voltage #4 Circuit – Voltage Above Normal, or Shorted to High Source
		4	Amber	238		Sensor Supply Voltage #3 Circuit – Voltage Below Normal, or Shorted to Low Source
Fuel Inlet Meter Device	611	16	Amber	2292		Fuel Inlet Meter Device - Data Valid but Above Normal Operational Range - Moderately Severe Level
		18	Amber	2293		Fuel Inlet Meter Device flow demand lower than expected - Data Valid but Below Normal Operational Range - Moderately Severe Level
Electronic Control Module		31	Amber	757		Electronic Control Module data lost - Condition Exists
System Diagnostic Code # 2	612	2	Red	115		Engine Speed / Position Sensor Circuit lost both of two signals from the magnetic pickup sensor - Data Erratic, Intermittent, or incorrect
Red Stop Lamp	623	4	Amber	244		Red Stop lamp Driver Circuit - Voltage Below Normal, or Shorted to Low Source
Power Supply	627	2	Amber	434		Power Lost without Ignition Off - Data Erratic, Intermittent, or Incorrect
Controller #1	629	12	Red	111		Engine Control Module Critical internal failure - Bad intelligent Device or Component
Calibration Memory	630	2	Amber	341	268	Engine Control Module data lost - Data Erratic, Intermittent, or Incorrect
		13	Red	342		Electronic Calibration Code Incompatibility - Out of Calibration
		31	Amber	2217		ECM Program Memory (RAM) Corruption - Condition Exists
Engine software	631	2	415		253	Data incorrect
Fuel Control Valve #1	633	31	Amber	2311		Fueling Actuator #1 Circuit Error – Condition Exists
Primary to secondary speed signal	637	11	143		261	Calibration fault
SAE J1939 Datalink	639	9	Amber	285	247	SAE J1939 Multiplexing PGN Timeout Error - Abnormal Update Rate
		13	Amber	286		SAE J1939 Multiplexing Configuration Error – Out of Calibration
Variable Geometry Turbocharger	641	3	Amber	2385		VGT Actuator Driver Circuit - Voltage Above Normal, or Shorted to High Source
		4	Amber	2384		VGT Actuator Driver Circuit - Voltage Below Normal, or Shorted to Low Source
Turbo Wastegate	646	5	177		526	Solenoid Current Low
		6	177		526	Solenoid Current High
Injector Cylinder #01	651	5	Amber	322	1	Injector Solenoid Cylinder #1 Circuit – Current Below Normal, or Open Circuit
		6	N/A		1	Injector Current High
		7	Amber	1139	1	Injector Cylinder #1 - Mechanical System Not Responding Properly or Out of Adjustment
Injector Cylinder #02	652	5	Amber	331	2	Injector Solenoid Cylinder #2 Circuit – Current Below Normal, or Open Circuit
		6	N/A		2	Injector Current High
		7	Amber	1141	2	Injector Cylinder #2 - Mechanical System Not Responding Properly or Out of Adjustment
Injector Cylinder #03	653	5	Amber	324	3	Injector Solenoid Cylinder #3 Circuit – Current Below Normal, or Open Circuit

ENGINE ERROR CODES

J1939 SPN Description	J1939 SPN	J1939 FMI	Lamp Color	Cummins Engine Code	Cat Engine Code	Cummins / Caterpillar Description
		6	N/A		3	Injector Current High
		7	Amber	1142	3	Injector Cylinder #3 - Mechanical System Not Responding Properly or Out of Adjustment
Injector Cylinder #04	654	5	Amber	332	4	Injector Solenoid Cylinder #4 Circuit – Current Below Normal, or Open Circuit
		6	N/A		4	Injector Current High
		7	Amber	1143	4	Injector Cylinder #4 - Mechanical System Not Responding Properly or Out of Adjustment
Injector Cylinder #05	655	5	Amber	323	5	Injector Solenoid Cylinder #5 Circuit – Current Below Normal, or Open Circuit
		6	N/A		5	Injector Current High
		7	Amber	1144	5	Injector Cylinder #5 - Mechanical System Not Responding Properly or Out of Adjustment
Injector Cylinder #06	656	5	Amber	325	6	Injector Solenoid Cylinder #6 Circuit – Current Below Normal, or Open Circuit
		6	N/A		6	Injector Current High
		7	Amber	1145	6	Injector Cylinder #6 - Mechanical System Not Responding Properly or Out of Adjustment
Glow Plug Start Aid relay	676	5	199		2246	Current Low
		6	199			Current High
Starter Solenoid Lockout Relay Driver Circuit	677	3	Amber	584		Starter Relay Circuit - Voltage Above Normal, or Shorted to High Source
		4	Amber	585		Starter Relay Circuit - Voltage Below Normal, or Shorted to Low Source
8V DC supply	678	3	517		41	ECM 8V DC supply – voltage above normal or shorted high
		4	517			ECM 8V DC supply – voltage below normal or shorted low
Engine Speed Sensor #2	723	2	Amber	753		Engine Speed/Position #2 Camshaft sync error -Data Erratic, Intermittent, or Incorrect
		7	Amber	731		Engine Speed/Position #2 mechanical misalignment between camshaft and crankshaft sensors - Mechanical System Not Responding Properly or Out of Adjustment
		8	142		342	Abnormal signal frequency
Intake Air Heater #1	729	3	Amber	2555		Intake Air Heater #1 Circuit - Voltage Above Normal, or Shorted to High Source
		4	Amber	2556		Intake Air Heater #1 Circuit - Voltage Below Normal, or Shorted to Low Source
Internal Sensor Voltage Supply	1043	3	Amber	387		Accelerator Pedal or Lever Position Sensor Supply Voltage Circuit - Voltage Above Normal, or Shorted to High Source
		4	Amber	284		Engine Speed/Position Sensor (Crankshaft) Supply Voltage Circuit - Voltage Below Normal, or Shorted to Low Source
Electric Lift Pump for Engine Fuel	1075	3	Amber	2265		Fuel Priming Pump Control Signal Circuit – Voltage Above Normal, or Shorted to High Source
		4	Amber	2266		Fuel Priming Pump Control Signal Circuit – Voltage Below Normal, or Shorted to Low Source
5 Volts DC Supply	1079	3	Amber	386	262	Sensor Supply Voltage #1 Circuit – Voltage Above Normal, or Shorted to High Source
		4	Amber	352	262	Sensor Supply Voltage #1 Circuit – Voltage Below Normal, or Shorted to Low Source
5 Volts DC Supply	1080	3	Amber	227		Sensor Supply Voltage #2 Circuit – Voltage Above Normal, or Shorted to High Source
		4	Amber	187		Sensor Supply Voltage #2 Circuit – Voltage Below Normal, or Shorted to Low Source
Sensor Circuit - Voltage	1136	3	Amber	697		ECM Internal Temperature Sensor Circuit - Voltage Above Normal, or Shorted to High Source
		4	Amber	698		ECM Internal Temperature Sensor Circuit - Voltage Below Normal, or Shorted to Low Source
Turbocharger #1 Compressor Inlet Temperature	1172	3	Amber	691		Turbocharger #1 Compressor Inlet Temperature Sensor Circuit – Voltage Above Normal, or Shorted to High Source
		4	Amber	692		Turbocharger #1 Compressor Inlet Temperature Sensor Circuit – Voltage Below Normal, or Shorted to Low Source
Turbo Wastegate	1188	7	177		526	Turbo Wastegate not responding

ENGINE ERROR CODES

J1939 SPN Description	J1939 SPN	J1939 FMI	Lamp Color	Cummins Engine Code	Cat Engine Code	Cummins / Caterpillar Description
Exhaust Gas Pressure	1209	3	Amber	2373		Exhaust Gas Pressure Sensor Circuit - Voltage Above Normal, or Shorted to High Source
		4	Amber	2374		Exhaust Gas Pressure Sensor Circuit - Voltage Below Normal, or Shorted to Low Source
Fuel Pump Pressurizing Assembly #1	1347	3	Amber	272		High Fuel Pressure Solenoid Valve Circuit – Voltage Above Normal, or Shorted to High Source
		4	Amber	271		High Fuel Pressure Solenoid Valve Circuit – Voltage Below Normal, or Shorted to Low Source
		5	162		1779	Output current low
		6	162		1779	Output current high
		7	Amber	281	1779	High Fuel Pressure Solenoid Valve #1 – Mechanical System Not Responding Properly or Out of Adjustment
Engine Oil Change Interval	1378	31	Maint	649		Change Lubricating Oil and Filter – Condition Exists
Auxiliary Pressure	1388	3	Amber	297		Auxiliary Pressure Sensor Input # 2 Circuit - Voltage Above Normal, or Shorted to High Source
		4	Amber	298		Auxiliary Pressure Sensor Input # 2 Circuit - Voltage Below Normal, or Shorted to Low Source
		14	Red	296		Auxiliary Pressure Sensor Input 1 - Special Instructions
J1939 Error	1484	31	None	211		Additional Auxiliary Diagnostic Codes logged - Condition Exists
Control Module Identification Input State	1563	2	Amber	1256		Control Module Identification Input State Error - Data Erratic, Intermittent, or Incorrect
Accelerator Pedal Position	2623	3	Amber	1239		Accelerator Pedal or Lever Position Sensor 2 Circuit - Voltage Above Normal, or Shorted to High Source
		4	Amber	1241		Accelerator Pedal or Lever Position Sensor 2 Circuit - Voltage Below Normal, or Shorted to Low Source
System Diagnostic Code #1	2629	15	None	2347		Turbocharger Compressor Outlet Temperature (Calculated) - Data Valid but Above Normal Operational Range – Least Severe Level
System Diagnostic Code #1	2789	15	None	2346		Turbocharger Turbine Inlet Temperature (Calculated) - Data Valid but Above Normal Operational Range – Least Severe Level
Coolant Pressure	2981	3	Amber	2115		Coolant Pressure 2 Circuit - Voltage Above Normal, or Shorted to High Source
		4	Amber	2116		Coolant Pressure 2 Circuit -Voltage Below Normal, or Shorted to Low Source
		18	Amber	2117		Coolant Pressure 2 - Data Valid but Below Normal Operational Range - Moderately Severe Level
System Diagnostic Code # 1	3511	4	Amber	238		Sensor Supply Voltage #3 Circuit – Voltage Below Normal, or Shorted to Low Source
		3	Amber	239		Sensor Supply Voltage #3 Circuit – Voltage Above Normal, or Shorted to High Source