

MacDon™

M150, M200 Self-Propelled Windrower

**UNLOADING AND ASSEMBLY
INSTRUCTIONS
for
NORTH AMERICAN SHIPMENTS**

Published: September, 2010

Form 169018

Revision C



MACDON SELF-PROPELLED WINDROWER

INTRODUCTION

This instructional manual describes the unloading, set-up and pre-delivery requirements for the MacDon M150 and M200 Self-Propelled Windrowers.

Use the Table of Contents to guide you to specific areas.

Retain this instruction for future reference.

CAREFULLY READ ALL THE MATERIAL PROVIDED BEFORE ATTEMPTING TO UNLOAD, ASSEMBLE, OR USE THE MACHINE.

TABLE OF CONTENTS

INTRODUCTION.....	1
GENERAL SAFETY	3
RECOMMENDED TORQUES	5
A. GENERAL.....	5
B. SAE BOLTS.....	5
C. METRIC BOLTS.....	5
D. FLARE TYPE HYDRAULIC FITTINGS.....	6
E. O-RING TYPE HYDRAULIC FITTINGS.....	6
ENGLISH/METRIC EQUIVALENTS	7
DEFINITIONS.....	7
STEP 1. UNLOAD WINDROWER	8
A. TWO FORKLIFT METHOD	8
B. SINGLE FORKLIFT METHOD	9
I. METHOD 1	9
II. METHOD 2	9
STEP 2. REPOSITION RH LEG.....	11
STEP 3. INSTALL FRONT WHEELS	12
STEP 4. REPOSITION CASTER WHEELS	12
STEP 5. INSTALL STEPS	13
STEP 6. INSTALL CENTER-LINK.....	14
STEP 7. INSTALL BATTERIES.....	14
STEP 8. INSTALL AM/FM RADIO.....	16
STEP 9. INSTALL SLOW MOVING VEHICLE (SMV) SIGN.....	17
STEP 10. ATTACH HEADER	18
A. HEADER ATTACHMENT - D SERIES.....	18
B. HEADER ATTACHMENT - A SERIES.....	24
C. HEADER ATTACHMENT - R SERIES.....	28
STEP 11. LUBRICATE MACHINE.....	32
STEP 12. PROGRAM CAB DISPLAY MODULE (CDM)	34
STEP 13. PERFORM PRE-DELIVERY CHECKS.....	40
A. FINAL DRIVE LUBRICANT LEVEL.....	40
B. TIRE PRESSURES AND BALLAST REQUIREMENTS.....	40
I. Tire Pressures	40
II. Ballast Requirements	40
C. ENGINE COOLANT	41
D. AIR CLEANER.....	42
E. HYDRAULIC OIL LEVEL.....	42
F. FUEL SEPARATOR	43
G. GEAR BOX LUBRICANT LEVEL	43
H. A/C COMPRESSOR BELT.....	43
I. PERFORM SAFETY SYSTEM CHECKS.....	44
J. OPERATIONAL CHECKS.....	45
I. ENGINE WARNING LIGHTS	45
II. START ENGINE	45
III. GAUGES AND CDM DISPLAY	47
IV. ELECTRICAL	47
V. ENGINE SPEED	47
VI. OPERATOR'S PRESENCE SYSTEM CHECKS	47
VII. EXTERIOR LIGHTS	48
VIII. BEACON (If Installed)	49
IX. HORN	49
X. INTERIOR LIGHTS	50
XI. A/C AND HEATER	50
K. MANUALS	50
L. CAB INTERIOR.....	50

GENERAL SAFETY



CAUTION

The following are general farm safety precautions that should be part of your operating procedure for all types of machinery.

- Protect yourself.
- When assembling, operating and servicing machinery, wear all the protective clothing and personal safety devices that **COULD** be necessary for the job at hand. Don't take chances.
- You may need:

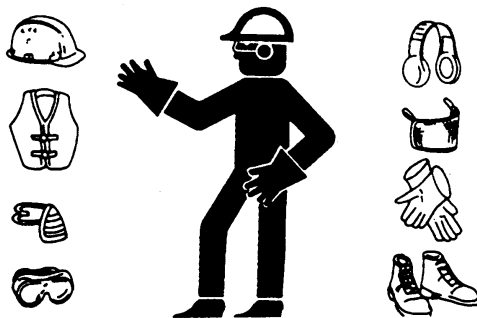

- a hard hat.
- protective shoes with slip resistant soles.
- protective glasses or goggles.
- heavy gloves.
- wet weather gear.
- respirator or filter mask.



- hearing protection. Be aware that prolonged exposure to loud noise can cause impairment or loss of hearing. Wearing a suitable hearing protective device such as ear muffs (A) or ear plugs (B) protects against objectionable or loud noises.



- Provide a first-aid kit for use in case of emergencies.
- Keep a fire extinguisher on the machine. Be sure the extinguisher is properly maintained and be familiar with its proper use.
- Keep young children away from machinery at all times.
- Be aware that accidents often happen when the operator is tired or in a hurry to get finished. Take the time to consider the safest way. Never ignore warning signs of fatigue.
- Wear close-fitting clothing and cover long hair. Never wear dangling items such as scarves or bracelets.
- Keep hands, feet, clothing and hair away from moving parts. Never attempt to clear obstructions or objects from a machine while the engine is running.

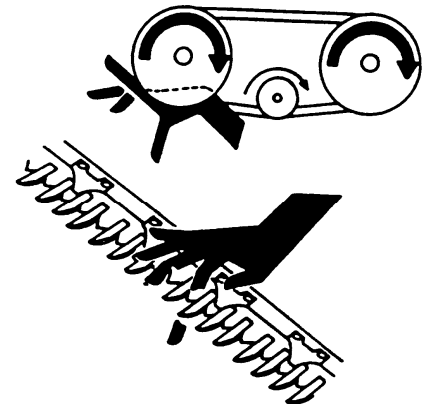

- Keep all shields in place. Never alter or remove safety equipment. Make sure driveline guards can rotate independently of the shaft and can telescope freely.
- Use only service and repair parts made or approved by the equipment manufacturer. Substituted parts may not meet strength, design, or safety requirements.

- **Do not modify the machine. Unauthorized modifications may impair the function and/or safety and affect machine life.**
- **Stop engine, and remove key from ignition before leaving operator's seat for any reason. A child or even a pet could engage an idling machine.**



- **Keep the area used for servicing machinery clean and dry. Wet or oily floors are slippery. Wet spots can be dangerous when working with electrical equipment. Be sure all electrical outlets and tools are properly grounded.**
- **Use adequate light for the job at hand.**
- **Keep machinery clean. Do not allow oil or grease to accumulate on service platforms, ladders or controls. Clean machines before storage.**
- **Never use gasoline, naphtha or any volatile material for cleaning purposes. These materials may be toxic and/or flammable.**
- **When storing machinery, cover sharp or extending components to prevent injury from accidental contact.**

RECOMMENDED TORQUES

A. GENERAL

The tables shown below give correct torque values for various bolts and capscrews.

- Tighten all bolts to the torques specified in chart unless otherwise noted throughout this manual.
- Check tightness of bolts periodically, using bolt torque chart as a guide.
- Replace hardware with the same strength bolt.
- Torque figures are valid for non-greased or non-oiled threads and heads unless otherwise specified. Do not grease or oil bolts or capscrews unless specified in this manual.
- When using locking elements, increase torque values by 5%.

B. SAE BOLTS

BOLT DIA. "A"	NC BOLT TORQUE *			
	SAE 5		SAE 8	
	ft-lbf	N-m	ft-lbf	N-m
1/4	9	12	11	15
5/16	18	24	25	34
3/8	32	43	41	56
7/16	50	68	70	95
1/2	75	102	105	142
9/16	110	149	149	202
5/8	150	203	200	271
3/4	265	359	365	495
7/8	420	569	600	813
1	640	867	890	1205

* Torque categories for bolts and capscrews are identified by their head markings.

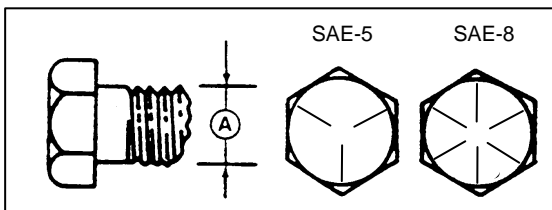

C. METRIC BOLTS

BOLT DIA. "A"	NC BOLT TORQUE *			
	8.8		10.9	
	ft-lbf	N-m	ft-lbf	N-m
M3	0.4	0.5	1.3	1.8
M4	2.2	3	3.3	4.5
M5	4	6	7	9
M6	7	10	11	15
M8	18	25	26	35
M10	37	50	52	70
M12	66	90	92	125
M14	103	140	148	200
M16	166	225	229	310
M20	321	435	450	610
M24	553	750	774	1050
M30	1103	1495	1550	2100
M36	1917	2600	2710	3675

* Torque categories for bolts and capscrews are identified by their head markings.

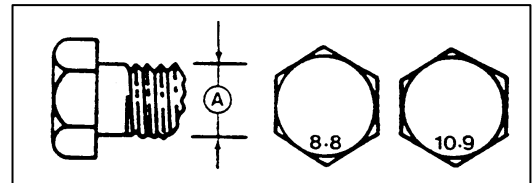

D. FLARE TYPE HYDRAULIC FITTINGS

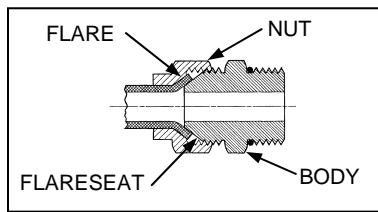

- Check flare and flare seat for defects that might cause leakage.
- Align tube with fitting before tightening.
- Lubricate connection and hand tighten swivel nut until snug.
- To prevent twisting the tube(s), use two wrenches. Place one wrench on the connector body and with the second tighten the swivel nut to the torque shown.

SAE NO.	TUBE SIZE O.D. (in.)	THD SIZE (in.)	NUT SIZE ACROSS FLATS (in.)	TORQUE VALUE*		RECOMMENDED TURNS TO TIGHTEN (AFTER FINGER TIGHTENING)	
				ft-lbf	N-m	Flats	Turns
3	3/16	3/8	7/16	6	8	1	1/6
4	1/4	7/16	9/16	9	12	1	1/6
5	5/16	1/2	5/8	12	16	1	1/6
6	3/8	9/16	11/16	18	24	1	1/6
8	1/2	3/4	7/8	34	46	1	1/6
10	5/8	7/8	1	46	62	1	1/6
12	3/4	1-1/16	1-1/4	75	102	3/4	1/8
14	7/8	1-3/8	1-3/8	90	122	3/4	1/8
16	1	1-5/16	1-1/2	105	142	3/4	1/8

* The torque values shown are based on lubricated connections as in reassembly.

E. O-RING TYPE HYDRAULIC FITTINGS

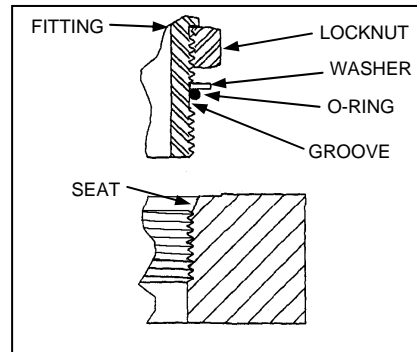

- Inspect O-ring and seat for dirt or obvious defects.

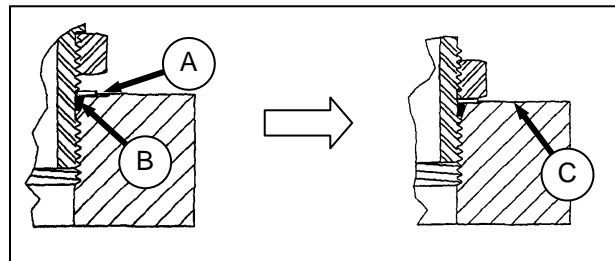

- On angle fittings, back off the lock nut until washer (A) bottoms out at top of groove (B) in fitting.
- Hand tighten fitting until back up washer (A) or washer face (if straight fitting) bottoms on part face (C) and O-ring is seated.
- Position angle fittings by unscrewing no more than one turn.
- Tighten straight fittings to torque shown.
- Tighten angle fittings to torque shown in the following table while holding body of fitting with a wrench.

SAE NO.	THD SIZE (in.)	NUT SIZE ACROSS FLATS (in.)	TORQUE VALUE*		RECOMMENDED TURNS TO TIGHTEN (AFTER FINGER TIGHTENING)	
			ft-lbf	N-m	Flats	Turns
3	3/8	1/2	6	8	2	1/3
4	7/16	9/16	9	12	2	1/3
5	1/2	5/8	12	16	2	1/3
6	9/16	11/16	18	24	2	1/3
8	3/4	7/8	34	46	2	1/3
10	7/8	1	46	62	1-1/2	1/4
12	1-1/16	1-1/4	75	102	1	1/6
14	1-3/16	1-3/8	90	122	1	1/6
16	1-5/16	1-1/2	105	142	3/4	1/8
20	1-5/8	1-7/8	140	190	3/4	1/8
24	1-7/8	2-1/8	160	217	1/2	1/12

* The torque values shown are based on lubricated connections as in reassembly.

ENGLISH/METRIC EQUIVALENTS

QUANTITY	INCH-POUND UNITS		FACTOR	SI UNITS (METRIC)	
	UNIT NAME	ABBR.		UNIT NAME	ABBR.
Area	acres	acres	x 0.4047 =	hectares	ha
Flow	US gallons per minute	(gpm)	x 3.7854 =	liters per minute	L/min
Force	pounds force	lbf	x 4.4482 =	Newtons	N
Length	inch	in.	x 25.4 =	millimeters	mm
	foot	ft	x 0.305 =	meters	m
Power	horsepower	hp	x 0.7457 =	kilowatts	kW
Pressure	pounds per square inch	psi	x 6.8948 =	kilopascals	kPa
			x .00689 =	megapascals	MPa
Torque	pound feet or foot pounds	lbf-ft or ft-lbf	x 1.3558 =	newton meters	N-m
	pound inches or inch pounds	lbf-in. or in-lbf	x 0.1129 =	newton meters	N-m
Temperature	degrees Fahrenheit	°F	(°F - 32) x 0.56 =	Celsius	°C
Velocity	feet per minute	ft/min	x 0.3048 =	meters per minute	m/min
	feet per second	ft/s	x 0.3048 =	meters per second	m/s
	miles per hour	mph	x 1.6063 =	kilometers per hour	km/h
Volume	US gallons	US gal.	x 3.7854 =	liters	L
	ounces	oz.	x 29.5735 =	milliliters	ml
	cubic inches	in. ³	x 16.3871 =	cubic centimeters	cm ³ or cc
Weight	pounds	lb	x 0.4536 =	kilograms	kg

DEFINITIONS

TERM	DEFINITION
API	American Petroleum Institute
ASTM	American Society of Testing And Materials
Cab-Forward	Windrower operation with the operator and cab facing in the direction of travel.
CDM	Cab Display Module
DWA	Double Windrow Attachment
Engine-Forward	Windrower operation with the operator and engine facing in the direction of travel.
ISC	Integrated Speed Control
N-DETENT	The slot opposite the neutral position on Operator's console.
rpm	revolutions per minute
SAE	Society Of Automotive Engineers
WCM	Windrower Control Module
Windrower	Windrower with header attached.
Windrower Tractor	Power unit only. (Windrower without the header attached)

UNLOADING AND ASSEMBLY

STEP 1. UNLOAD WINDROWER



CAUTION

To avoid injury to bystanders from being struck by machinery, do not allow persons to stand in unloading area.

A. TWO FORKLIFT METHOD



CAUTION

Equipment used for unloading must meet or exceed the requirements specified below. Using inadequate equipment may result in chain breakage, vehicle tipping or machine damage.

LIFTING VEHICLE	
Minimum Lifting Capacity *	5500 lb (2500 kg)
Minimum Fork Length	78 in. (1981 mm)

* At 48 inches (1220 mm) from back end of forks.

IMPORTANT

Forklifts are normally rated for a load located 24 inches (610 mm) ahead of back end of the forks.

To obtain the forklift capacity at 48 inches (1220 mm), check with your forklift distributor.

- Move trailer into position, and block trailer wheels.
- Set forklift tines to the widest possible setting.



- Position one forklift on either side of trailer and position forks under windrower frame.

NOTE

Windrower center of gravity is approximately 55 inches (1397 mm) rearward of drive wheel center.

- Lift with both forklifts simultaneously until windrower is clear of trailer bed.



WARNING

Be sure forks are secure before moving trailer away from load. Stand clear when lifting.

- Drive the truck slowly forward until trailer bed is clear of windrower.
- Lower unit slowly and simultaneously with both forklifts to the ground. Place wooden blocks under front shipping stands, if ground is soft.
- Back off forklifts.
- Check windrower for shipping damage, and check shipment for missing parts.

UNLOADING AND ASSEMBLY

B. SINGLE FORKLIFT METHOD

I. METHOD 1



CAUTION

Equipment used for unloading must meet or exceed the requirements specified below. Using inadequate equipment may result in chain breakage, vehicle tipping or machine damage.

LIFTING VEHICLE	
Minimum Lifting Capacity *	5500 lb (2500 kg)

* At 48 inches (1220 mm) from back end of forks.

IMPORTANT

Forklifts are normally rated for a load located 24 inches (610 mm) ahead of back end of the forks.

To obtain the forklift capacity at 48 inches (1220 mm), check with your forklift distributor.

CHAIN	
Type	Overhead Lifting Quality (1/2 inch)
Minimum Working Load	5000 lb (2270 kg)

- a. Position rear of trailer against unloading dock that is the same height or slightly lower than the trailer bed.
- b. Remove shipped parts from under windrower frame.
- c. Set forklift tines to widest possible setting.

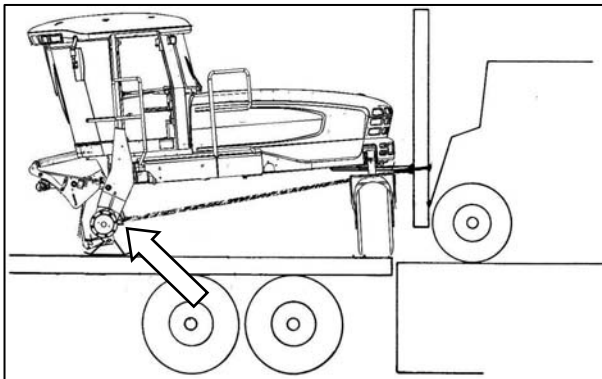

- d. Position forklift up to rear of windrower, and place forks under the rear frame cross member.
- e. Install chains from forklift mast to jacking brackets on both front legs of windrower.

- f. Chains must be the same length.



CAUTION

The front legs rest on the trailer bed on skid shoes. Ensure there are no obstructions to prevent rearward sliding of the skid shoes and watch carefully that as unit is dragged, the skid shoes are not sliding sideways towards the edge of the trailer bed.

- g. Drag windrower rearward off of carrier.
- h. Remove chains and back off the forklift.
- i. Check windrower for shipping damage, and check shipment for missing parts.

II. METHOD 2



CAUTION

Equipment used for unloading must meet or exceed the requirements specified below. Using inadequate equipment may result in chain breakage, vehicle tipping or machine damage.

LIFTING VEHICLE	
Minimum Lifting Capacity *	11000 lb (4994 kg)
Minimum Fork Length	78 in. (1981 mm)

* At 48 in. (1220 mm) from back end of forks.

IMPORTANT

Forklifts are normally rated for a load located 24 inches (610 mm) ahead of back end of the forks.

To obtain the forklift capacity at 48 inches (1220 mm), check with your forklift distributor.



WARNING

Be sure forks are secure before moving away from load. Stand clear when lifting.

- a. Move trailer into position, and block trailer wheels.
- b. Set forklift tines to the widest possible setting.

(continued next page)

UNLOADING AND ASSEMBLY



- c. Position forklift on left or right side of trailer, and position forks under windrower frame.

NOTE

Windrower center of gravity is approximately 55 inches (1397 mm) rearward of drive wheel center.



WARNING

Ensure forks project beyond far side of frame.

- d. Lift until windrower is clear of trailer bed.
- e. Slowly back forklift away from trailer until windrower is clear of trailer.
- f. Lower unit slowly to the ground. Place wooden blocks under front shipping stands, if ground is soft.
- g. Back off forklift.
- h. Check windrower for shipping damage, and check shipment for missing parts.

UNLOADING AND ASSEMBLY

STEP 2. REPOSITION RH LEG

Only the right cab-forward leg requires repositioning from shipping to field configuration.

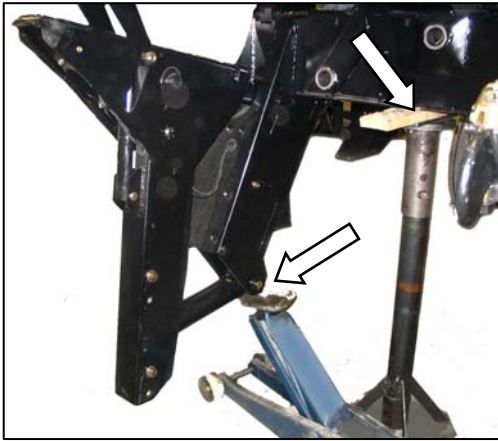

- Support the front of the windrower with stand (or equivalent) so that the RH leg is off the ground.
- Position jack under RH leg, and raise jack slightly to take some weight off leg.

IMPORTANT

Removal of pins will be difficult if jack is not positioned to take weight off leg.

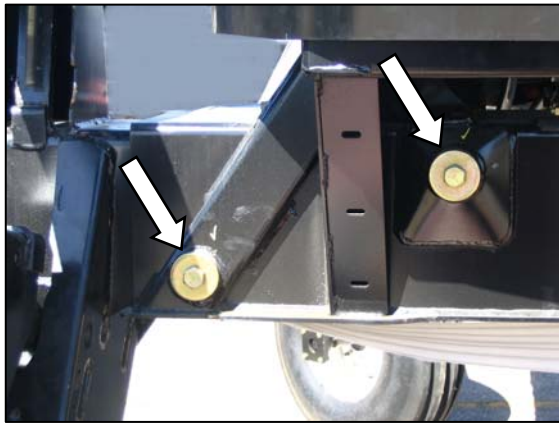

- Remove two bolts, washers, and nuts from frame.

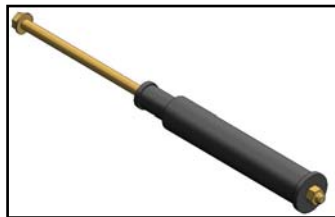

TOOL 163841

- Adjust jack height while observing pin position in bore. When pin is loosest, tap out pin with hammer or use tool to extract pin.

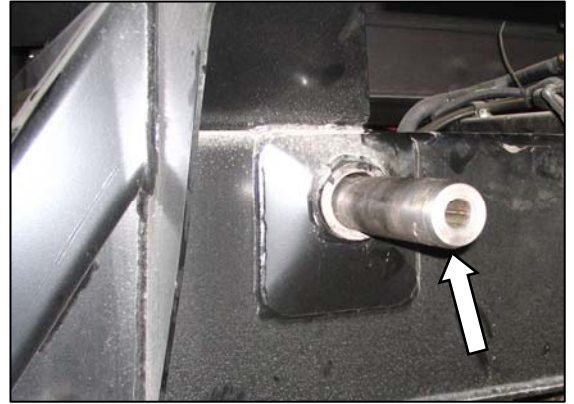

- Repeat above step for second pin.
- Move leg out to expose one hole.

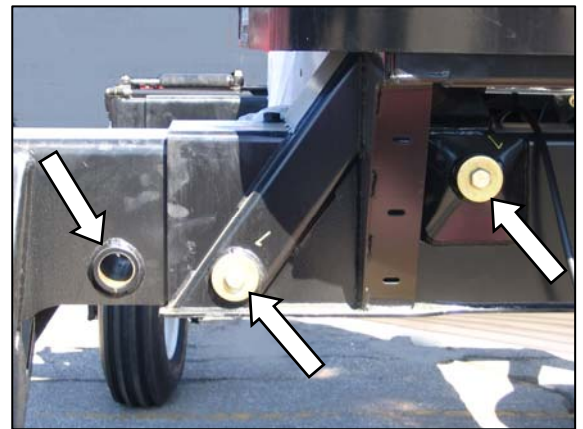

- Reinstall pins and secure with bolts, washers, and nuts (not shown). Torque nuts to 100 ft-lbf (136 N-m).

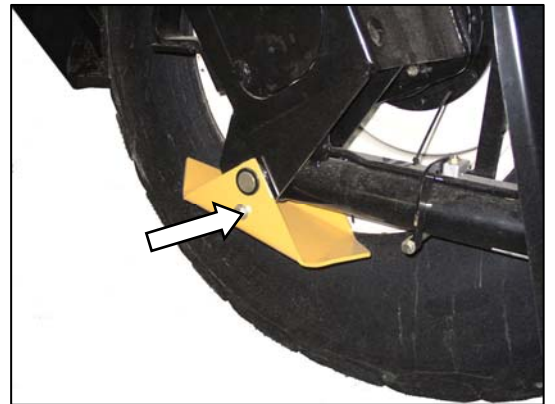

- Remove bolt and shipping skids from legs.

UNLOADING AND ASSEMBLY

STEP 3. INSTALL FRONT WHEELS



- a. Position wheel against hub, so that that air valves are on outside and tire tread point forward.

For "Turf" tires (diamond tread), be sure arrow on sidewall points in forward rotation.

- b. Lift wheel on hub with a forklift (or equivalent). Lower forklift.
- c. Rotate wheel to align holes with studs, and push wheel onto studs.

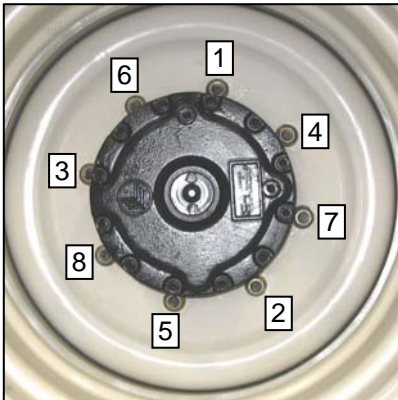

- d. Install wheel nuts, and tighten to 220 ft·lbf (300 N·m) using the tightening sequence as shown.

NOTE

To avoid damage to wheel disks, do not over-tighten wheel nuts.

- e. Repeat sequence three times.

STEP 4. REPOSITION CASTER WHEELS

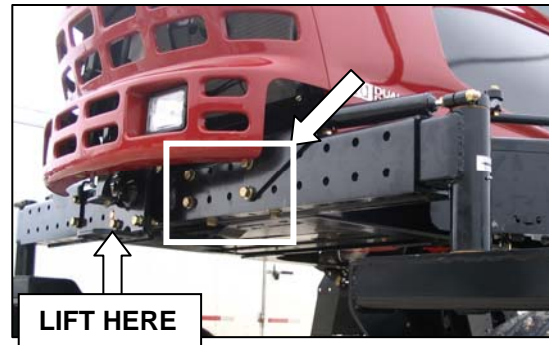

- a. Raise rear of windrower slightly so that most of the weight is off the casters, using a jack or other lifting device under the frame where shown.

NOTE

Lifting device should have a lifting capacity of at least 5000 lb (2270 kg).

- b. Remove six bolts (four on backside, two on underside), and washers from left and right side of walking beam.



- c. Slide extensions outboard equal amounts, and align holes at desired location.

NOTE

Use the caster wheels to assist in moving the axle by rotating the caster so that wheel is parallel to the axle.

(continued next page)

UNLOADING AND ASSEMBLY

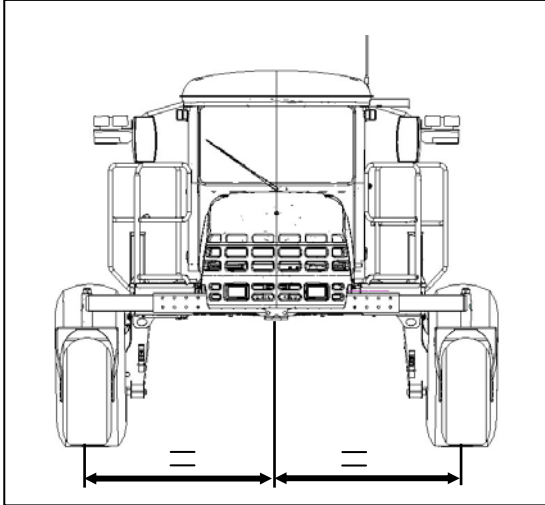

NOTE

Illustration shows widest tread width.

IMPORTANT

Caster wheels must be equidistant from center of windrower.

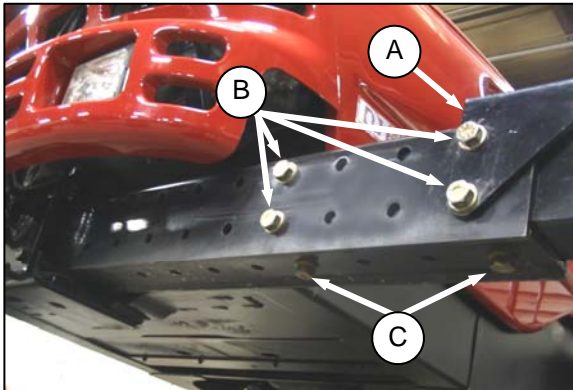

- d. Position bracket (A), and install bolts (B). The two shorter bolts are installed at the back inboard locations.
- e. Install bottom bolts (C).
- f. Tighten bolts as follows:
 1. Snug bottom bolts (C).
 2. Tighten and torque back bolts (B) to 330 ft·lbf (447 N·m).
 3. Tighten and torque bottom bolts (C) to 330 ft·lbf (447 N·m).
- g. Lower windrower to ground.

IMPORTANT

Re-torque bolts after first 5, and 10 hours of operation.

STEP 5. INSTALL STEPS

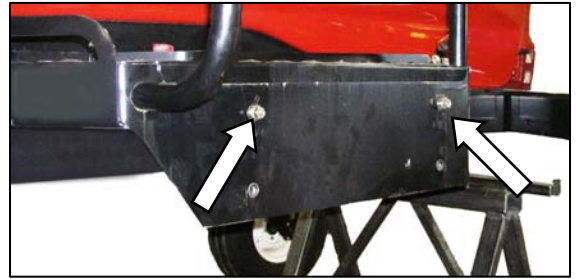

- a. Install two ½ in. x 1.0 hex bolts in upper holes in platform. Do not thread in fully.

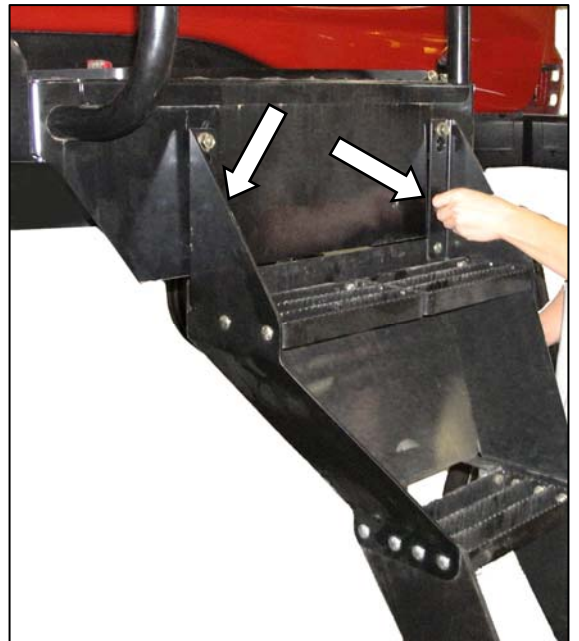

- b. Hang step assembly (both step assemblies are the same) on bolts.
- c. Install two ½ in. x 1.0 long hex bolts in lower holes in step, and tighten.
- d. Tighten upper bolts installed in step a.
- e. Repeat for other step assembly.

UNLOADING AND ASSEMBLY

STEP 6. INSTALL CENTER-LINK

MECHANICAL LINK - M150 ONLY

- a. Remove clevis pin from center-link.



- b. Position link between mounting brackets on front frame, and attach at lower hole location.
c. Install clevis pin, and secure with hair pin.

HYDRAULIC LINK - M200 STD, M150 OPTION



The hydraulic center-link is supplied in a separate kit that is included with the shipment. Refer to installation instructions in the kit.

STEP 7. INSTALL BATTERIES

- a. Open the hood at the lowest position as follows:

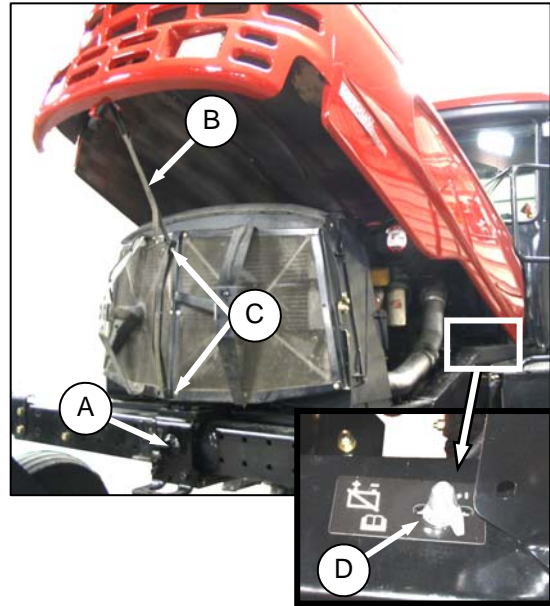

1. Locate latch (A) behind grill, and lift to release hood.
 2. Raise hood until strap (B), which should be looped under hooks (C), stops it at approximately a 40° angle.
- b. Check battery disconnect switch (D) is turned off.

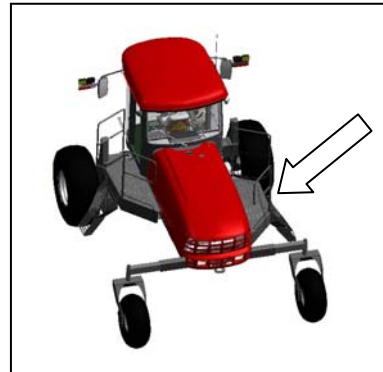

- c. Open right hand (cab-forward) maintenance platform.
- d. Remove cable ties securing battery clamps and cables to frame.

(continued next page)

UNLOADING AND ASSEMBLY

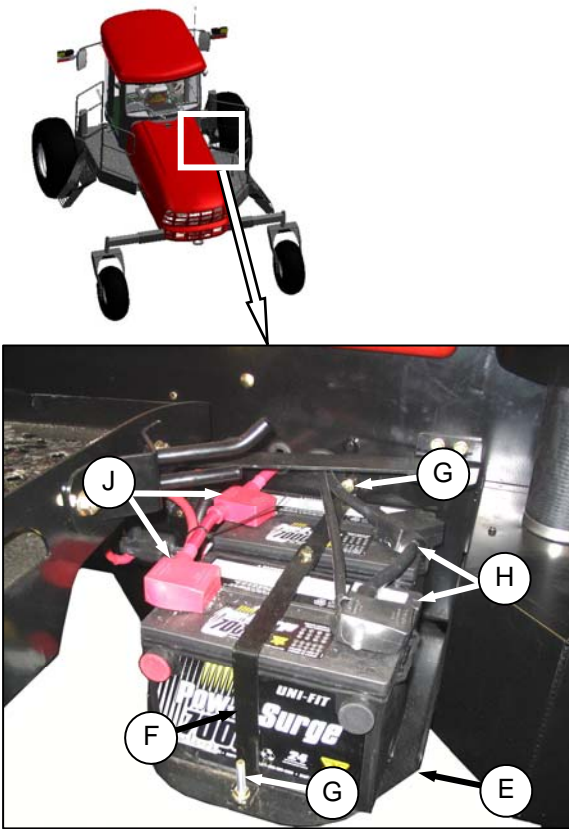

- e. Position new batteries on holder (E).

RATING	GROUP	CCA	VOLT	MAX. DIMENSION
Heavy Duty, Off-Road, Vibration Resistant	BCI 31A	750	12	13 x 6.81 x 9.44 in. (330 x 173 x 240 mm)

- f. Install clamp (F) with bolts (G) provided, and tighten securely.

IMPORTANT

BATTERY IS NEGATIVE GROUNDED.

Always connect starter cable to the positive (+) terminal of battery and battery ground cable to negative (-) terminal of battery. Reversed polarity in battery or alternator may result in permanent damage to electrical system.

- g. Attach positive (red) cable clamps (J) to positive post on batteries, and tighten. Reposition plastic covers onto clamps.
- h. Attach negative (black) cable clamps (H) to negative post on batteries, and tighten clamps.
- i. Move platform back to closed position.
- j. Close engine compartment hood.

UNLOADING AND ASSEMBLY

STEP 8. INSTALL AM/FM RADIO

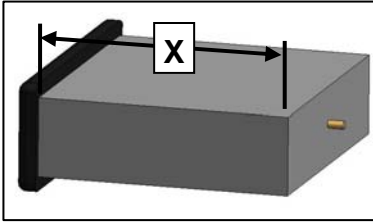

Provision has been made for installation of AM/FM radio. The mounting is designed to fit a DIN E style radio with a depth of "X" = 161 mm, and having a 5 mm threaded stud centered on the rear for support.

Provision has been made for adjustments should the radio fall outside these parameters.

- a. Ensure the battery disconnect switch is turned to the OFF position, and the ignition is turned to the OFF position.

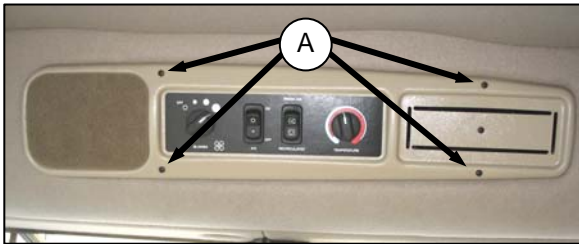

- b. Remove radio panel by removing four screws (A).

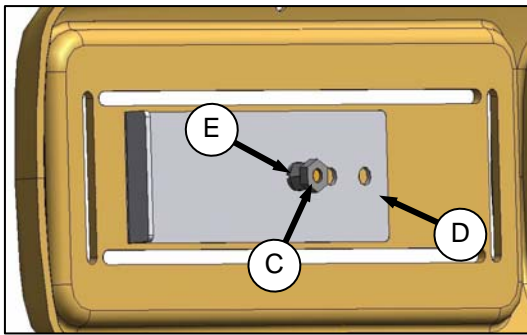

- c. Remove screw and nut (C) to remove support (D) from panel. Retain metric nut (E) and lockwasher.

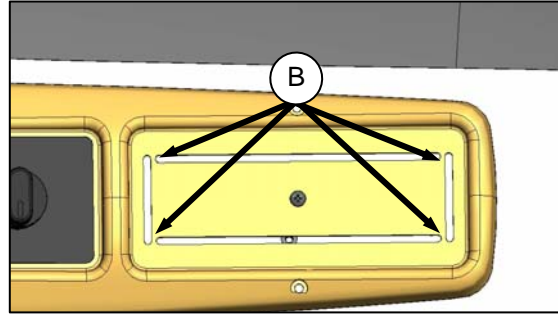

- d. Remove the cut-out by cutting the tabs (B) in the panel. Remove sharp edges on panel.

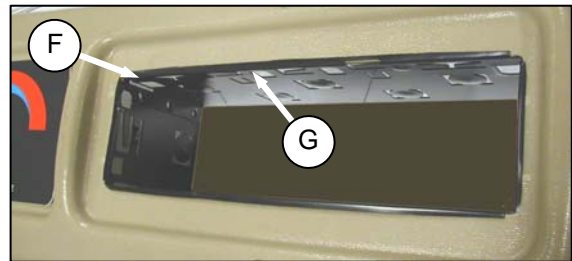

- e. Locate receptacle (F) (supplied with radio) in opening, and secure by bending tabs (G) on receptacle against panel.

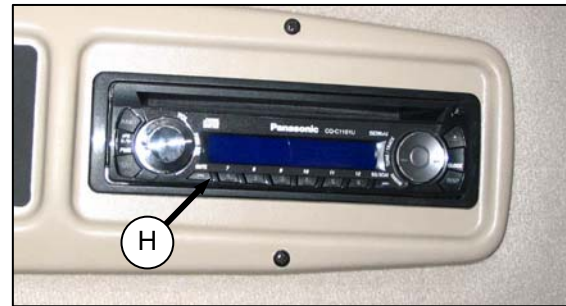

- f. Insert radio into receptacle, and attach radio bezel. Ensure radio locks into position, and faceplate (H) is against the panel.
- g. A six-pin connector for the radio is included in the wiring harness.

In order to mate properly with this connector, the radio must have a six-pin connector (Packard #2977042), and have a terminal arrangement as follows:

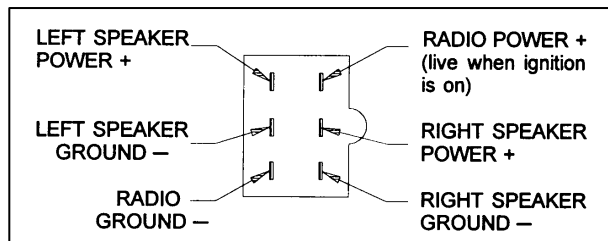

(continued next page)

UNLOADING AND ASSEMBLY

- h. Attach two additional wires in the wiring harness to the radio:
 - 1. Circuit 503 - Red with 1/4 in. female blade terminal. This is a live wire provided for powering a radio clock/memory, if these exist on your radio.
 - 2. Circuit 315 - Black ground wire attaches to radio body.
- i. Plug cable from antenna into radio.

NOTE

An approved radio package is available from Radio Engineering Industries (REI) of Omaha, Nebraska.

- j. Attach stud (supplied with radio) to center rear of radio.
- k. Attach support (D) to stud on back of radio chassis with lock washer and metric nut (E) that was supplied with the support.

Support can be attached to chassis in multiple locations to allow for proper mounting of radio.
- l. Reinstall radio panel with original screws.

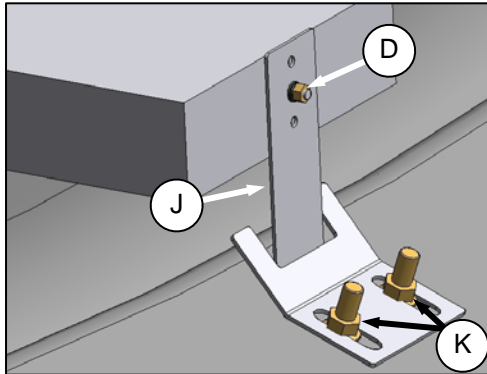
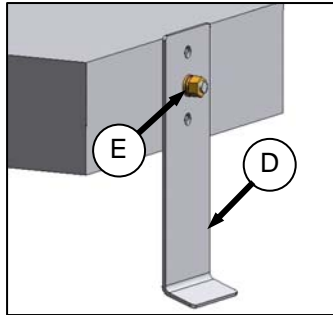

- m. Adjust bracket (J) if necessary by loosening nuts (K) to allow radio to slide into opening, and securely capture support (D).
- n. Turn battery disconnect switch to ON position.
- o. Turn ignition key to ACC, switch on the radio, and check operation in accordance with instructions supplied with the radio.

STEP 9. INSTALL SLOW MOVING VEHICLE (SMV) SIGN



Install SMV sign in accordance with instructions supplied with the kit.

UNLOADING AND ASSEMBLY

STEP 10. ATTACH HEADER

A. HEADER ATTACHMENT - D SERIES

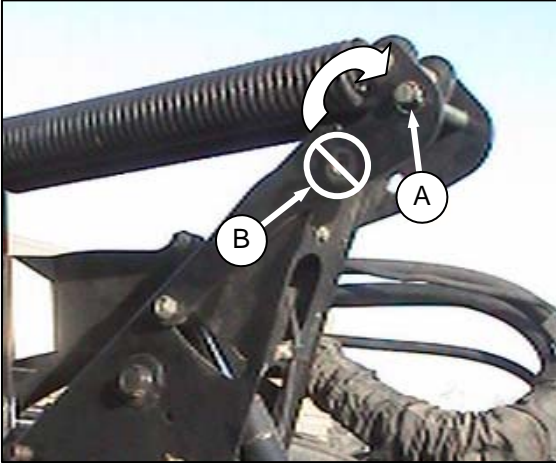

IMPORTANT

To prevent damage to the lift system when lowering header lift linkages without a header or weight box attached to windrower, ensure that float engagement pin is installed in storage location (A), and **not** installed at hole location (B).

- a. If not installed, attach draper header boots (supplied with header) to windrower lift linkage as follows:



DANGER

Stop engine, and remove key from ignition before leaving operator's seat for any reason. A child or even a pet could engage an idling machine.

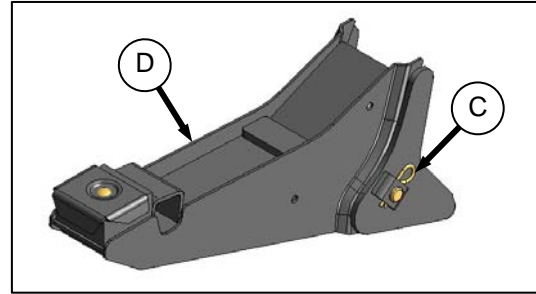

1. Remove pin (C) from boot (D).

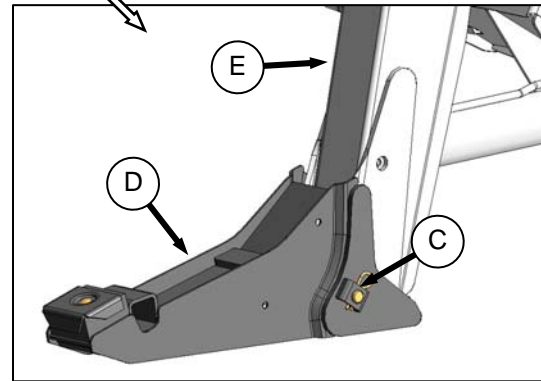

2. Locate boot (D) on lift linkage (E), and reinstall pin (C). Pin may be installed from either side of boot.
3. Secure pin (C) with hairpin.
4. Repeat for opposite lift linkage.

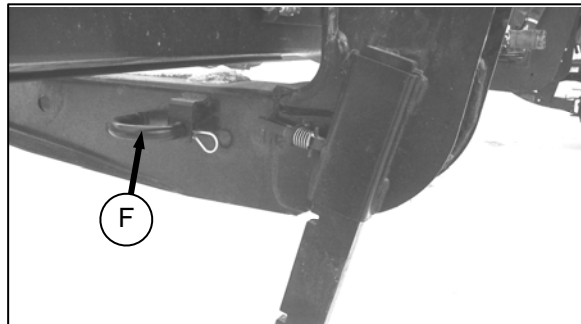

- b. Remove hairpin on pins (F) and remove pins from header legs.

(continued next page)

UNLOADING AND ASSEMBLY



CAUTION

Check to be sure all bystanders have cleared the area.

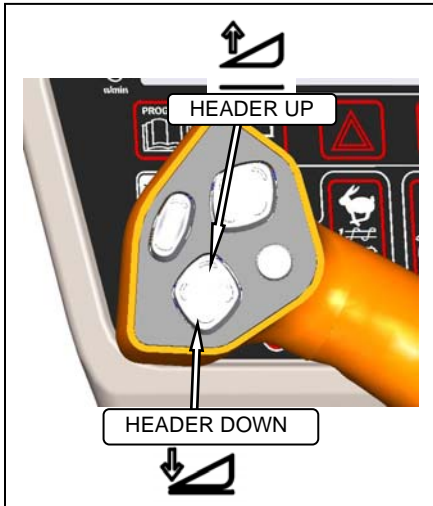

- c. Start the engine, and activate HEADER DOWN switch on the GSL to fully retract header lift cylinders.

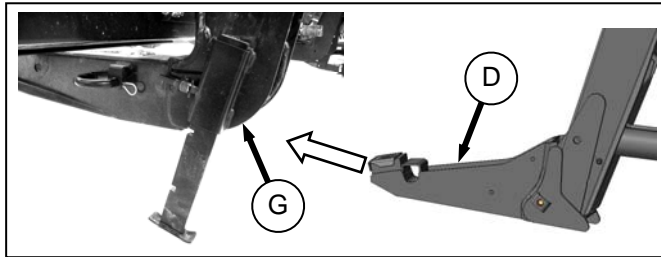

- d. Slowly drive windrower forward so that boots (D) enter header legs (G). Continue to drive slowly forward until linkages contact support plates in the lower header legs, and header nudges forward.
- e. Check that linkages are properly engaged in header legs, contacting support plates.
- f. Connect center-link as follows:

MECHANICAL LINK - M150



DANGER

Stop engine, and remove key from ignition before leaving operator's seat for any reason. A child or even a pet could engage an idling machine.

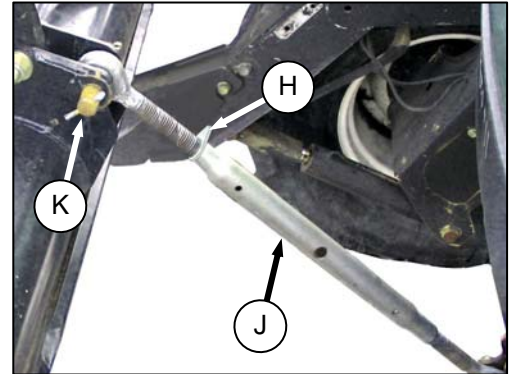

1. Loosen nut (H) and rotate barrel (J) to adjust length so that link lines up with header bracket.
2. Install pin (K) and secure with cotter pin.
3. Adjust link to required length for proper header angle by rotating barrel (J). Tighten nut (H) against barrel. A slight tap with a hammer is sufficient.
4. Start engine, and proceed to step g.

HYDRAULIC LINK WITHOUT SELF-ALIGNMENT KIT - M200 STD, M150 OPTION

1. Stop engine.

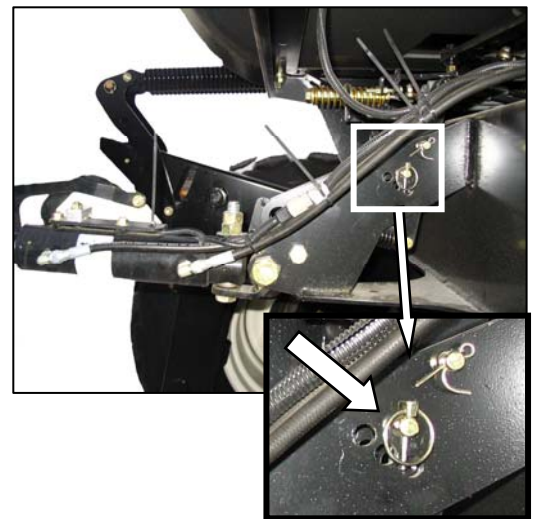

2. Relocate the pin at the frame linkage as required to position the hook over the header pin.

(continued next page)

UNLOADING AND ASSEMBLY

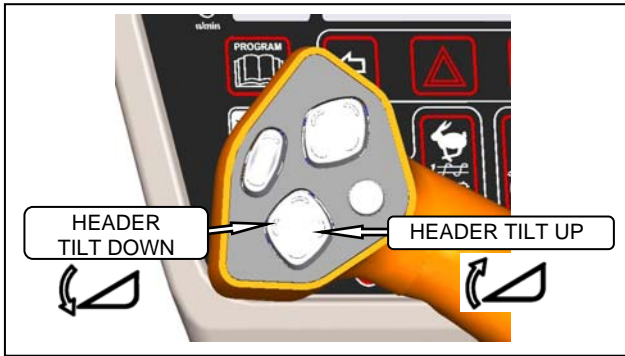

3. Start engine, and activate HEADER TILT switches on GSL to extend or retract center-link cylinder so that the hook lines up with the header attachment pin.
4. Stop engine.

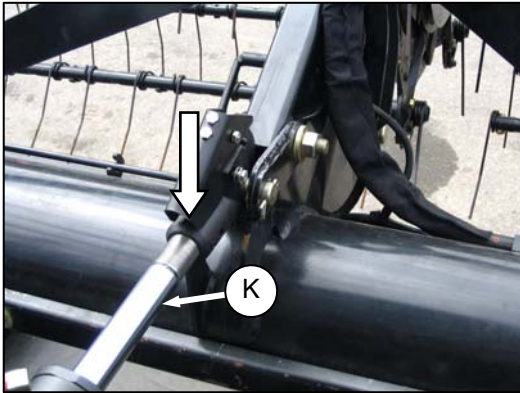

5. Push down on rod end of link cylinder (K) until hook engages pin on header, and is locked.
6. Check that center-link is locked onto header by pulling upward on rod end of cylinder.



CAUTION

Check to be sure all bystanders have cleared the area.

7. Start engine, and proceed to step g.

HYDRAULIC LINK WITH OPTIONAL SELF-ALIGNMENT KIT

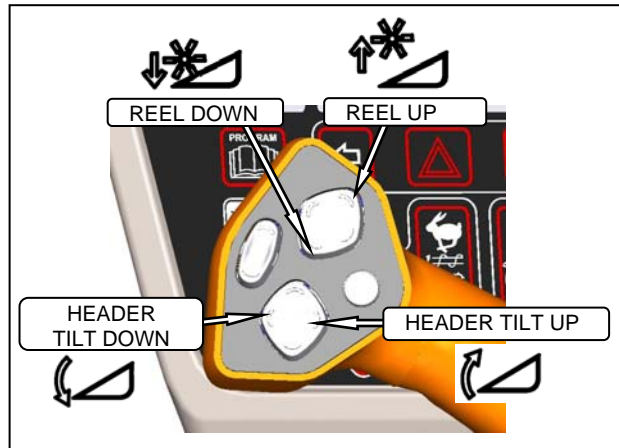

1. Adjust the position of the center-link cylinder with the REEL UP and REEL DOWN switches, and HEADER TILT switches on the GSL to position the hook above the header attachment pin.



2. Lower the center-link onto the header with REEL DOWN switch until it locks into position (handle is down).
- g. Raise the header fully with the HEADER UP switch on the GSL. Stop engine, and remove key.



DANGER

To avoid bodily injury from fall of raised header, always engage header lift cylinder stops when working on or around raised header.

- h. Engage lift cylinder stops on both lift cylinders.

(continued next page)

UNLOADING AND ASSEMBLY

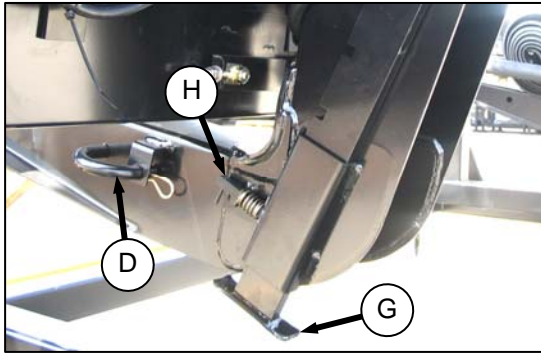

- i. Install pin (D) through header leg, (engaging U-bracket in header leg) on both sides.
- j. Raise header stand (G) to storage position, by pulling pin (H), and lifting stand into uppermost position. Release pin (H).

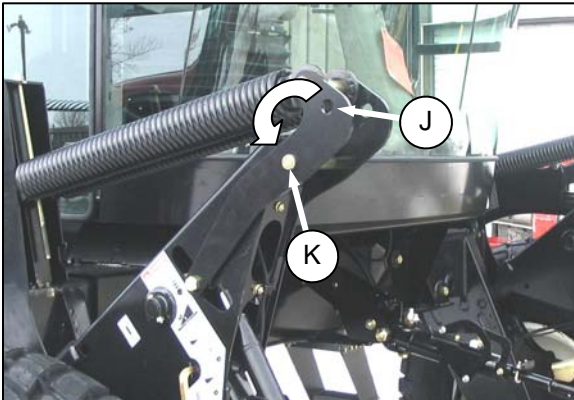

- k. Remove pin from storage position (J) in linkages on both sides, and insert in hole (K) to engage float springs. Secure with hairpin.
- l. Disengage lift cylinder stops.



CAUTION

Check to be sure all bystanders have cleared the area.

- m. Start engine, and activate HEADER DOWN switch on GSL to lower header fully.



DANGER

Stop engine, and remove key from ignition before leaving operator's seat for any reason. A child or even a pet could engage an idling machine.

- n. Stop engine, and remove key.

- o. The M150 and M200 Windrowers may not be factory equipped with D Series header and reel hydraulics as shown below.

- If not equipped, proceed to step p. to install kit.
- If equipped, go to step q. to connect to header.

NOTE

Windrowers equipped with D-Series hydraulics have four header drive hoses on the LH side, and up to five reel drive hoses on the RH side.



(continued next page)

UNLOADING AND ASSEMBLY

- p. If required, configure the M150 or M200 to run a D-Series draper header by installing a reel drive / lift kit. See table below for appropriate kit(s). The kits include all necessary hardware and installation instructions, and should have been provided with the windrower shipment.

	REEL DRIVE / LIFT KIT
M150	B5426
M200	B5426 and B4651

- q. Connect header drive hydraulics, and electrical harness to header as follows:

1. Check connectors and clean if required.

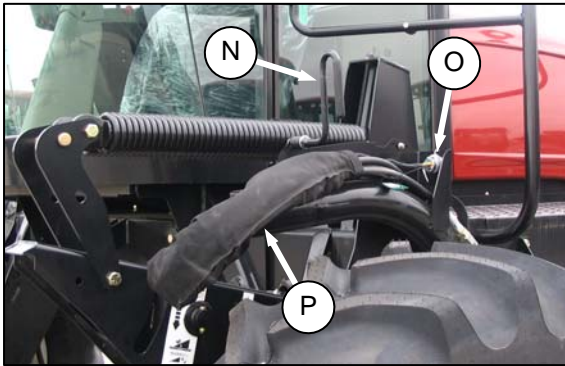

2. Disengage and rotate lever (N) counter clockwise to fully up position.
3. Remove cap (O) securing electrical connector to frame.
4. Move hose bundle (P) from tractor around hose support on header.



9. Lower lever (N) and engage in down position.

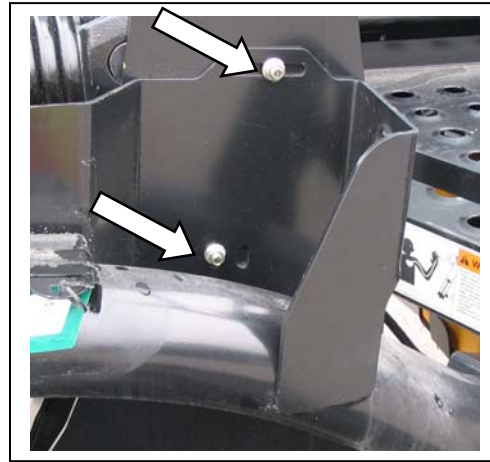

- r. Check that hose support is positioned so that top bolt is midway in slot, and lower bolt is in forward hole. Loosen bolts and adjust as required.

(continued next page)

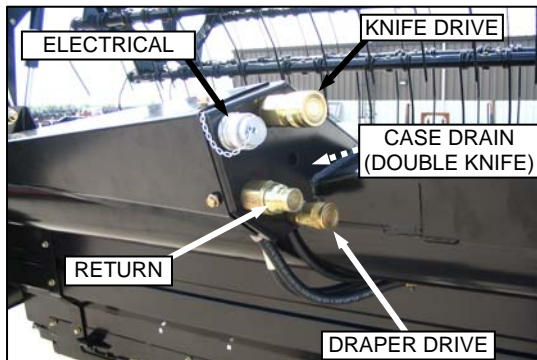

5. Push hose connectors onto mating receptacle until collar on receptacle snaps into lock position.
6. Remove cover on electrical receptacle.
7. Push electrical connector onto receptacle, and turn collar on connector to lock it in place.
8. Attach cover to mating cover on tractor wiring harness.

UNLOADING AND ASSEMBLY

- s. Connect reel hydraulics (Q) as follows:

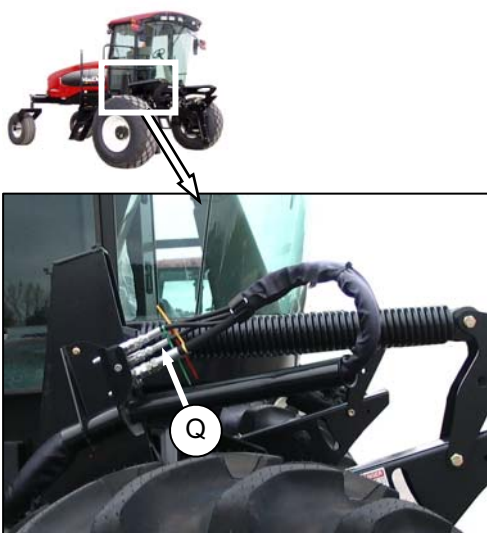

1. Check connectors, and clean if required.

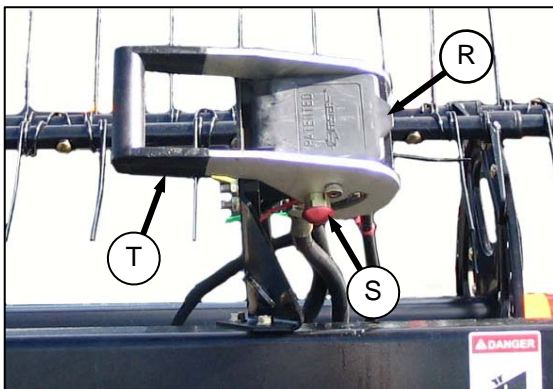

2. Open cover (R) on header receptacle.
3. Push in lock button (S), and pull handle (T) to "half open" position.

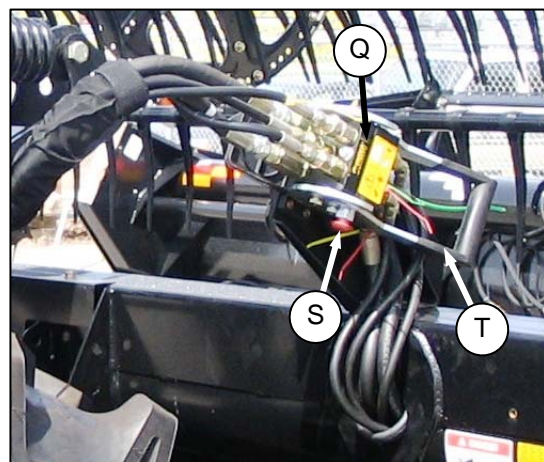

4. Remove hose bundle with multi-coupler (Q) from tractor, position onto header receptacle, and push handle (T) to engage pins on connector.
5. Push handle away from hoses until lock button (S) snaps out.



CAUTION

Check to be sure all bystanders have cleared the area.

- t. Start engine, and raise and lower header and reel a few times, to allow trapped air to pass back to the reservoir.

UNLOADING AND ASSEMBLY

B. HEADER ATTACHMENT - A SERIES

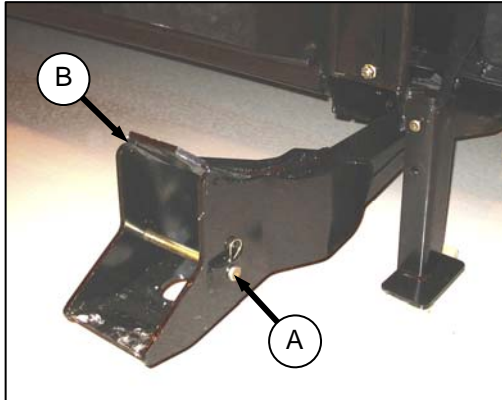

- a. Remove hairpin from pin (A), and remove pin from left and right header boots (B).

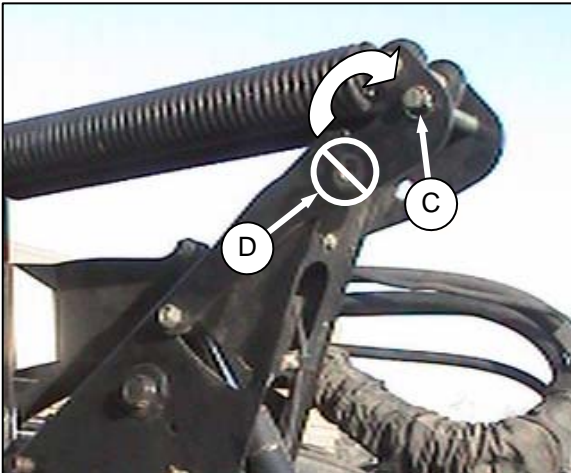

IMPORTANT

To prevent damage to the lift system when lowering header lift linkages without a header or weight box attached to windrower, ensure that float engagement pin is installed in storage location (C), and **not** installed at hole location (D).



CAUTION

Check to be sure all bystanders have cleared the area.

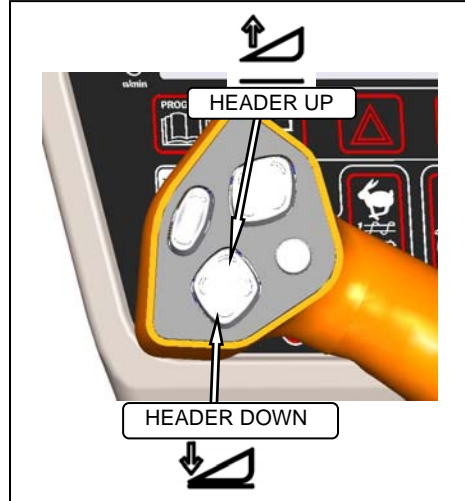

- b. Start engine, and activate HEADER DOWN switch on the GSL to fully retract header lift cylinders.

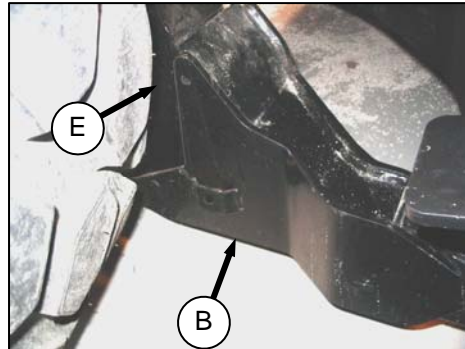

- c. Slowly drive windrower forward so that feet (E) on windrower enter boots (B) on the header. Continue to drive slowly forward until feet engage the boots, and header nudges forward.

(continued next page)

UNLOADING AND ASSEMBLY

d. Connect center-link as follows:

MECHANICAL LINK - M150



DANGER

Stop engine, and remove key from ignition before leaving operator's seat for any reason. A child or even a pet could engage an idling machine.

1. Stop engine, and remove key.

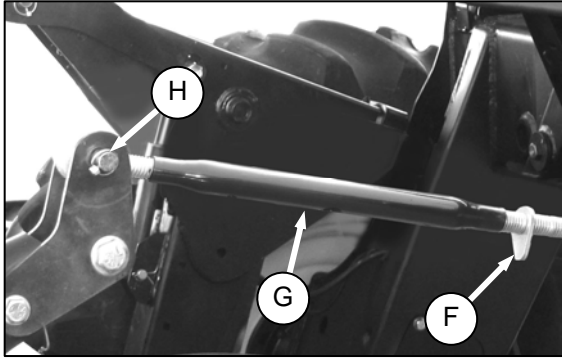

2. Loosen nut (F), and rotate barrel (G) to adjust length so that other end lines up with header bracket.
3. Install pin (H), and secure with cotter pins.
4. Adjust link to required length for proper header angle by rotating barrel (G). Tighten nut (F) against barrel. A slight tap with a hammer is sufficient.



CAUTION

Check to be sure all bystanders have cleared the area.

5. Start engine, and proceed to step e.

HYDRAULIC LINK WITHOUT SELF-ALIGNMENT KIT - M200 STD, M150 OPTION

1. Stop engine, and remove key.



2. Relocate the pin at the frame linkage as required to position the hook over the header pin.

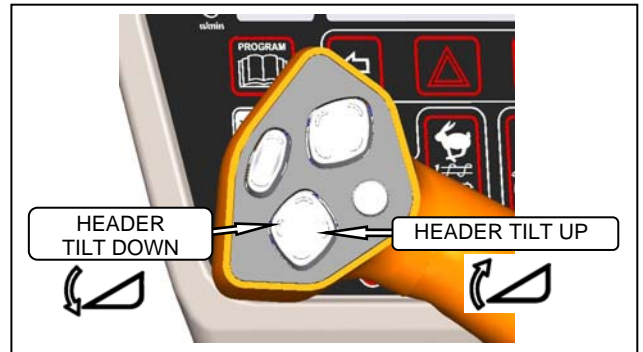

3. Start engine, and activate HEADER TILT switches on GSL to extend or retract center-link cylinder so that the hook lines up with the header attachment pin.
4. Stop engine.

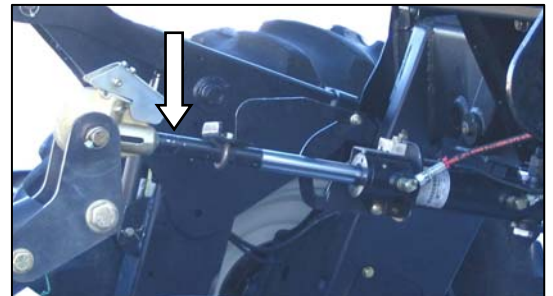

5. Push down on rod end of link cylinder until hook engages pin on header and is locked.
6. Check that center-link is locked onto header by pulling upward on rod end of cylinder.
7. Start engine, and proceed to step e.

(continued next page)

UNLOADING AND ASSEMBLY

HYDRAULIC LINK WITH OPTIONAL SELF-ALIGNMENT KIT

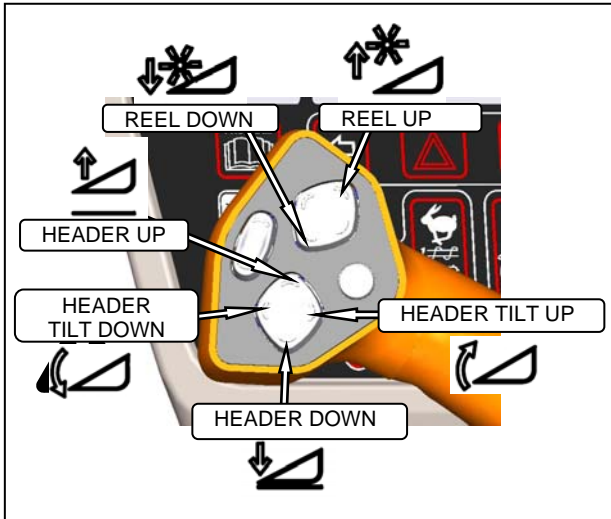

1. Adjust the position of the center-link cylinder with the REEL UP and REEL DOWN switches, and HEADER TILT switches on the GSL to position the hook above the header attachment pin.

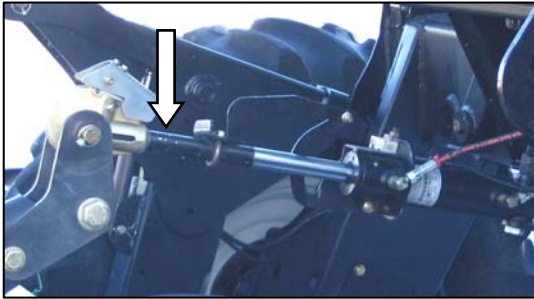

2. Lower the center-link onto the header with REEL DOWN switch, until it locks into position (handle is down).



CAUTION

Check to be sure all bystanders have cleared the area.

- e. Raise the header fully with the HEADER UP switch on the GSL. Stop engine, and remove key.



DANGER

To avoid bodily injury from fall of raised header, always engage header lift cylinder stops when working on or around raised header.

- f. Engage lift cylinder stops on both lift cylinders.

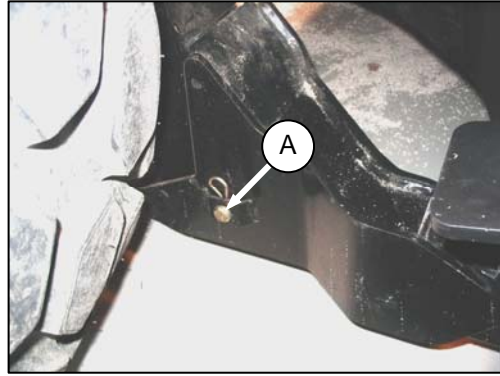

- g. Install pin (A) through each boot and foot, and secure with hairpin.

IMPORTANT

Ensure pin (A) is fully inserted, and hairpin is installed behind bracket on boot.

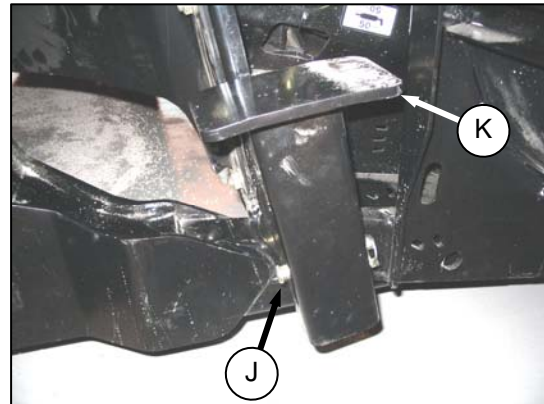

- h. Remove lynch pin from pin (J) in stand (K).
- i. Hold stand and remove pin (J).
- j. Reposition stand to storage position by inverting stand, and re-locating on bracket as shown. Reinsert pin (J), and secure with lynch pin.

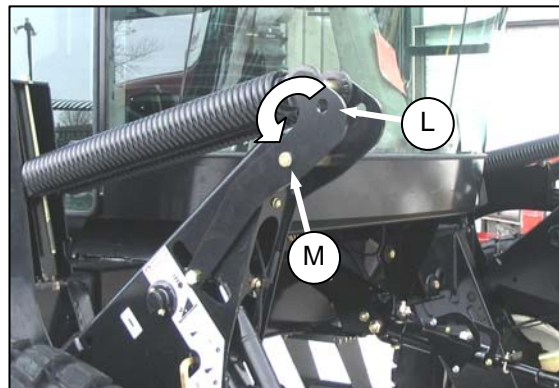

- k. Remove pin from storage position (L) in linkages on both sides, and insert in hole (M) to engage float springs. Secure with lynch pin.

(continued next page)

UNLOADING AND ASSEMBLY

- l. Disengage lift cylinder stops.



CAUTION

Check to be sure all bystanders have cleared the area.

- m. Start engine, and activate HEADER DOWN switch on GSL to lower header fully. Stop engine, and remove key.



- n. The M150 Windrower is factory equipped with A Series header hydraulics and electrical harness as shown above. Proceed to step p.

NOTE

If M200 Windrower is not similarly equipped, go to step o.

- o. If required, configure the M200 to run an auger header by installing Kit B4651. The kit includes all necessary hardware and installation instructions, and should have been provided with the windrower shipment.
- p. Connect hydraulics and electrical harness as shown in opposite column.

Refer to the A30S, A30D, and A40D Auger Self-Propelled Windrower Header Unloading and Assembly Instructions, or the A30S and A30D Pull-Type Mower Conditioners, and A30S, A30D and A40D Self-Propelled Auger Headers Operator's Manual for detailed procedures.

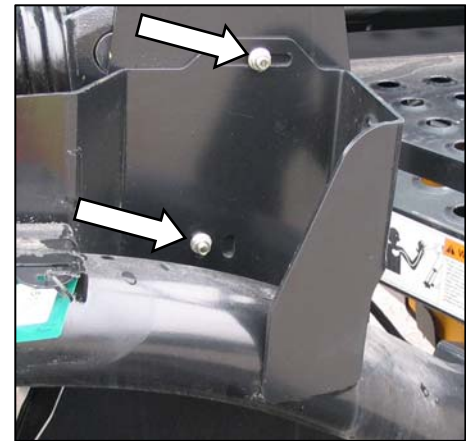
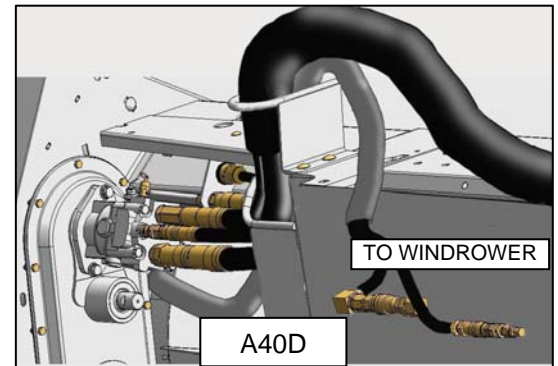
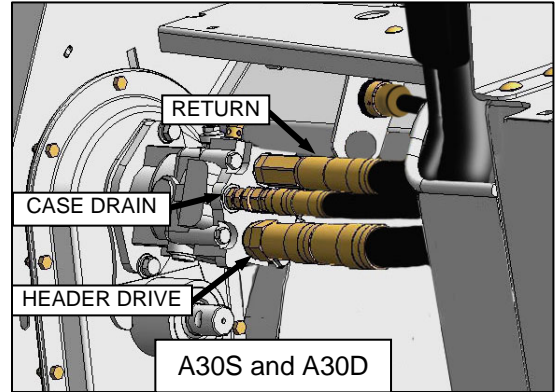

- q. Check that hose support is positioned so that top bolt is midway in slot, and lower bolt is in forward hole. Loosen bolts, and adjust as required.

IMPORTANT

Ensure hose bundles are clear of tire.

UNLOADING AND ASSEMBLY

C. HEADER ATTACHMENT - R SERIES

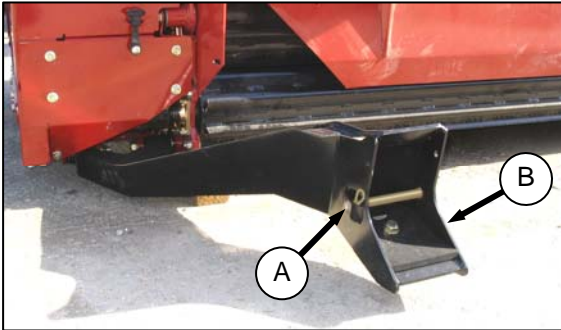

- a. Remove hairpin from pin (A), and remove pin from on left and right header boots (B) on header.

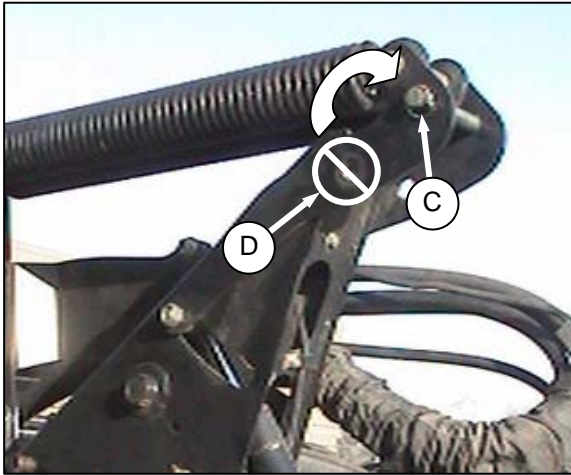

IMPORTANT

To prevent damage to the lift system when lowering header lift linkages without a header or weight box attached to windrower, ensure that float engagement pin is installed in storage location (C), and **not** installed at hole location (D).



CAUTION

Check to be sure all bystanders have cleared the area.

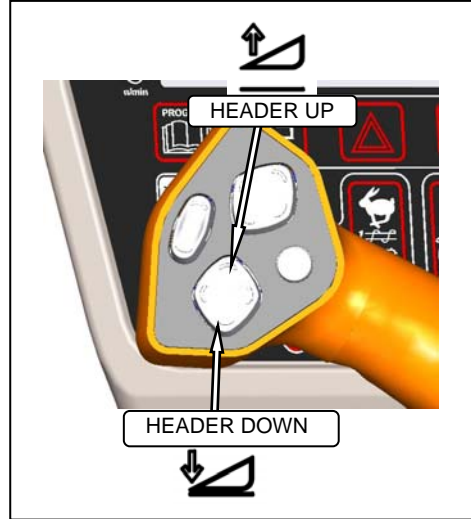

- b. Start the engine and activate HEADER DOWN button on the GSL to fully retract header lift cylinders.

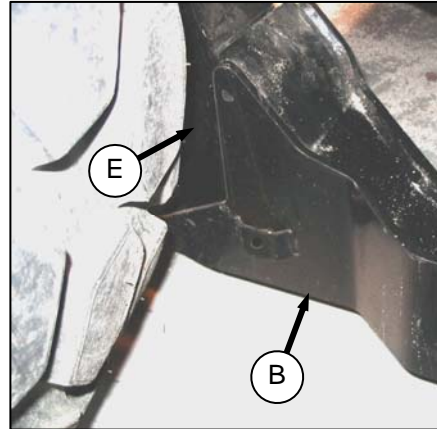

- c. Slowly drive windrower forward so that feet (E) on windrower enter boots (B) on the header. Continue to drive slowly forward until feet engage the boots, and header nudges forward.

(continued next page)

UNLOADING AND ASSEMBLY

d. Connect center-link as follows:

MECHANICAL LINK - M150



DANGER

Stop engine, and remove key from ignition before leaving operator's seat for any reason. A child or even a pet could engage an idling machine.

1. Stop engine, and remove key.

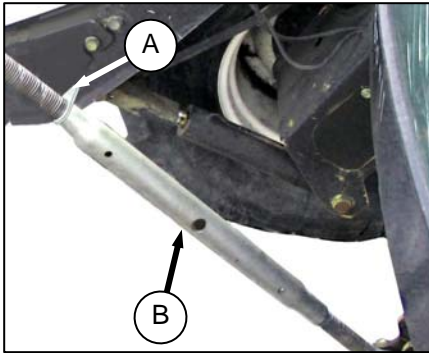

2. Loosen nut (A), and rotate barrel (B) to adjust length so that other end lines up with header bracket.

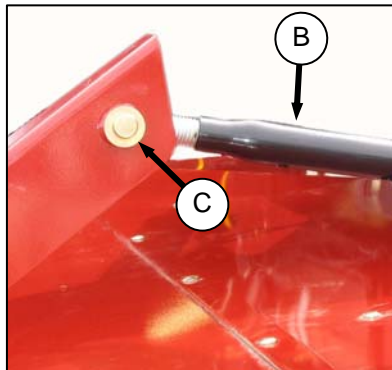

3. Install clevis pin (C) and secure with cotter pin.
4. Adjust link to required length for proper header angle by rotating barrel (B). Tighten nut (A) against barrel. A slight tap with a hammer is sufficient.



CAUTION

Check to be sure all bystanders have cleared the area.

5. Start engine, and proceed to step e.

HYDRAULIC LINK WITHOUT SELF-ALIGNMENT KIT - M200 STD, M150 OPTION

1. Stop engine, and remove key.

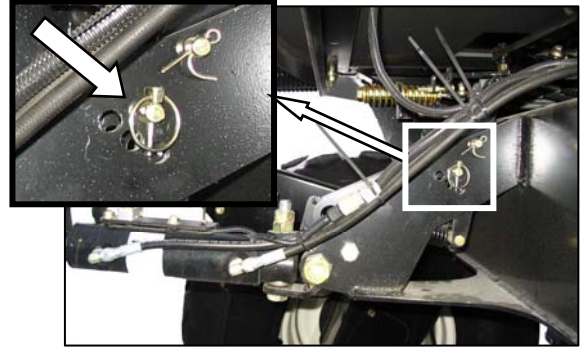

2. Relocate the pin at the frame linkage as required to position the hook over the header pin.

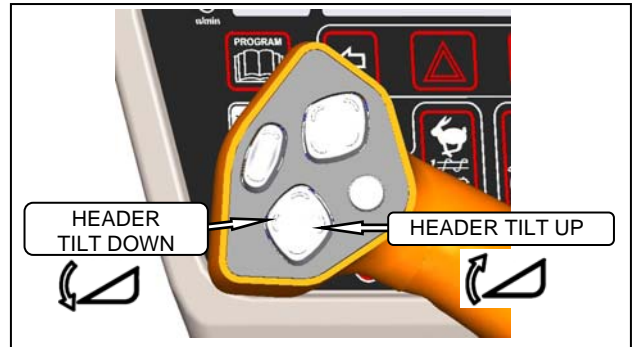

3. Start engine, and activate HEADER TILT switches on GSL to extend or retract center-link cylinder so that the hook lines up with the header attachment pin.

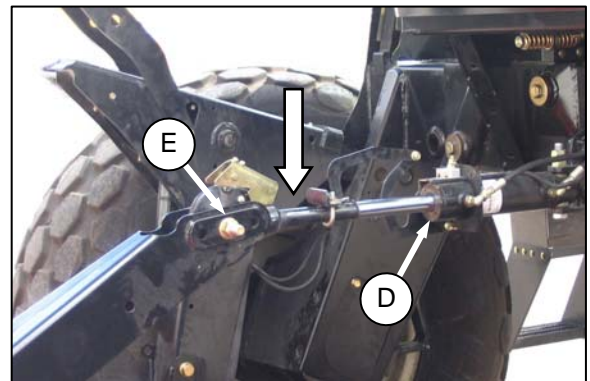

4. Push down on rod end of link cylinder (D) until hook engages pin (E) on header and is locked.
5. Check that center-link is locked onto header by pulling upward on rod end of cylinder.
6. Start engine, and proceed to step e.

(continued next page)

UNLOADING AND ASSEMBLY

HYDRAULIC LINK WITH OPTIONAL SELF-ALIGNMENT KIT

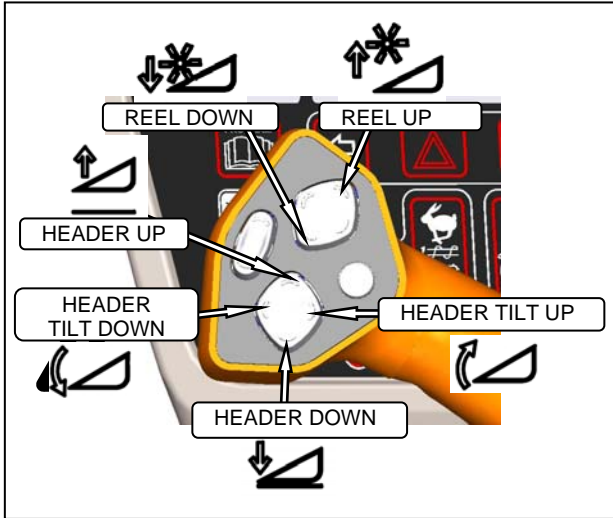

1. Adjust the position of the center-link cylinder with the REEL UP and REEL DOWN switches, and HEADER TILT switches on the GSL to position the hook above the header attachment pin.

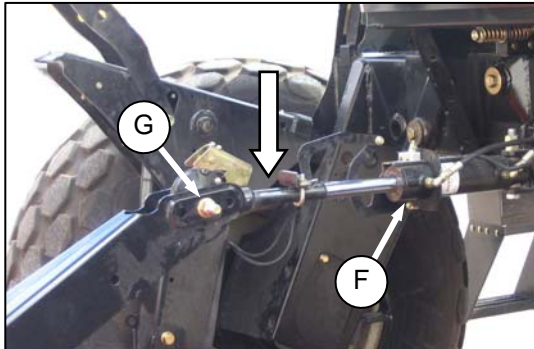

2. Lower the center-link (F) with the REEL DOWN switch onto the header pin (G) until it locks into position (handle is down).
- e. Raise the header fully with the HEADER UP switch on the GSL. Stop engine, and remove key.



DANGER

To avoid bodily injury from fall of raised header, always engage header lift cylinder stops when working on or around raised header.

- f. Stop engine, and engage lift cylinder stops on both lift cylinders.

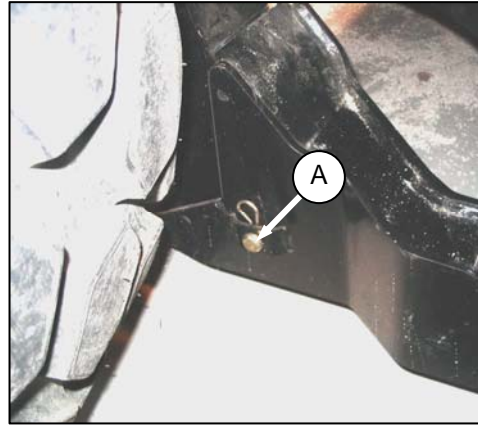

- g. Install pin (A) through each boot and foot and secure with hairpin.

IMPORTANT

Ensure pin (A) is fully inserted and hairpin is installed behind bracket on boot.

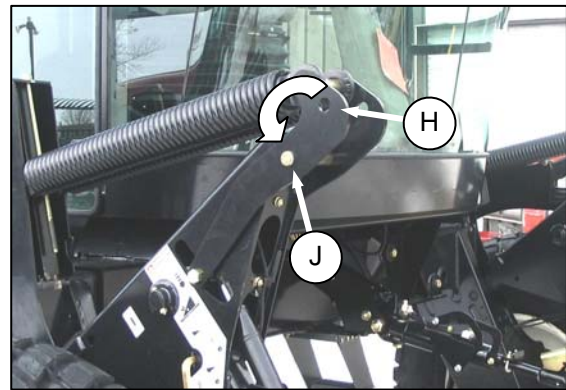

- h. Remove pin from storage position (H) in linkages on both sides and insert at location (J) to engage float springs. Secure with hairpin.
- i. Disengage lift cylinder stops.



CAUTION

Check to be sure all bystanders have cleared the area.

- j. Start engine, and activate HEADER DOWN switch on GSL to lower header fully. Stop engine, and remove key.



DANGER

Stop engine, and remove key from ignition before leaving operator's seat for any reason. A child or even a pet could engage an idling machine.

(continued next page)

UNLOADING AND ASSEMBLY



- k. The M200 Windrower is factory equipped with R Series rotary header hydraulics and electrical harness as shown above. Proceed to step m.

NOTE

If M150 Windrower is not similarly equipped, go to step l to install kit.

NOTE

Windrowers equipped with R-Series hydraulics have three hoses.

- l. If required, configure the M150 to run an R-Series rotary header by installing Kit B4657. The kit includes all necessary hardware and installation instructions, and should have been provided with the windrower shipment.
- m. Connect hydraulics and electrical harness as shown below. Refer to the R80 Rotary Disc Self-Propelled Windrower Header Unloading and Assembly Instructions, or the R80 Rotary Disc Self-Propelled Header Operator's Manual for detailed procedures.

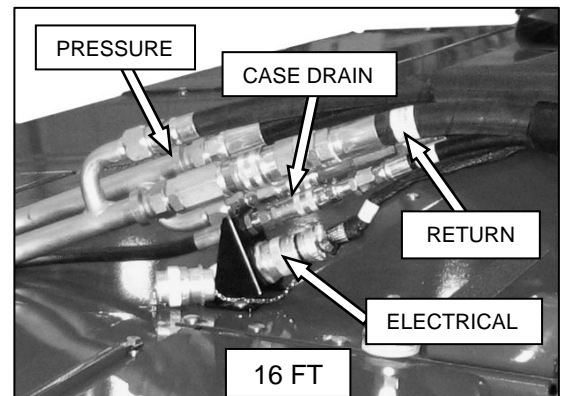
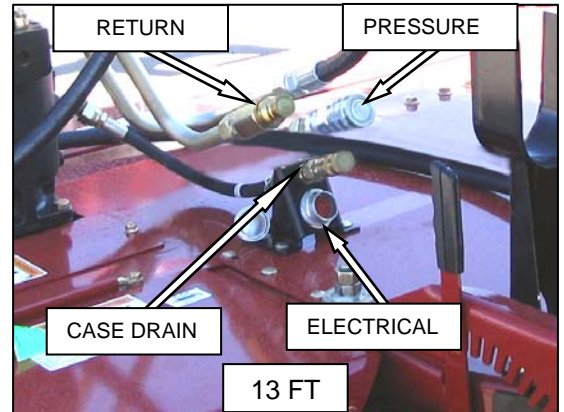

HEADER CONNECTIONS

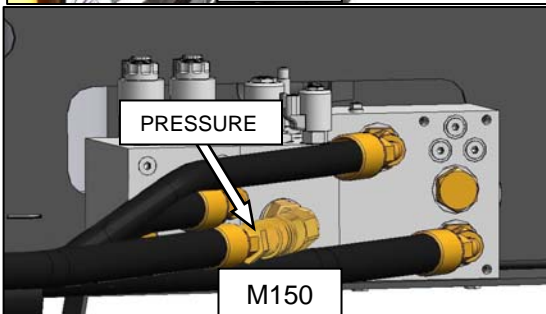
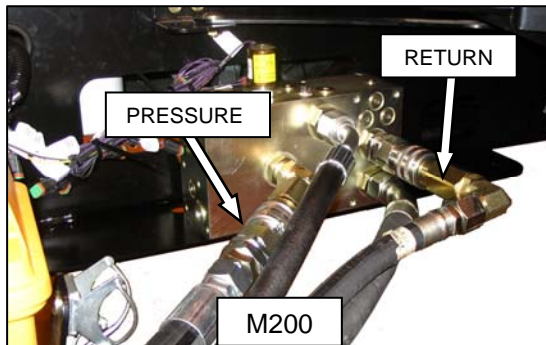

WINDROWER CONNECTIONS

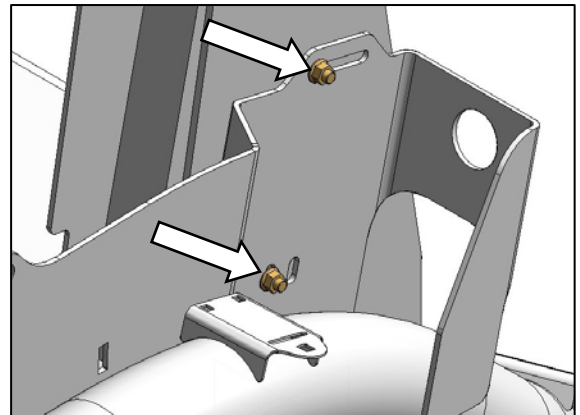

- n. Check that hose support is positioned so that lower bolt is in forward hole, and support is positioned as shown. Loosen bolts and adjust as required.

IMPORTANT

Ensure hose bundles are clear of tire.

UNLOADING AND ASSEMBLY

STEP 11. LUBRICATE MACHINE

Recommended Lubricant

SPEC	DESCRIPTION	USE
SAE Multi-Purpose	High Temp. Extreme Pressure (EP2) Performance With 1% Max Molybdenum Disulphide (NLGI Grade 2) Lithium Base	As Required Unless Otherwise Specified

- a. Wipe grease fitting with a clean cloth before greasing, to avoid injecting dirt and grit.
- b. Inject grease through fitting with grease gun until grease overflows fitting, except where noted.
- c. Leave excess grease on fitting to keep out dirt.
- d. Replace any loose or broken fittings immediately.
- e. If fitting will not take grease, remove and clean thoroughly. Also clean lubricant passageway. Replace fitting if necessary.
- f. Refer to the following illustrations for identifying the various locations that require lubrication.

(continued next page)

UNLOADING AND ASSEMBLY

Lubrication Points

High Temp. Extreme Pressure (EP2) Performance With 1% Max Molybdenum Disulphide (NLGI Grade 2).Lithium Base

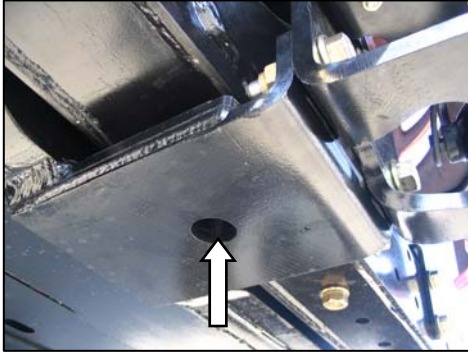

WALKING BEAM PIVOT)

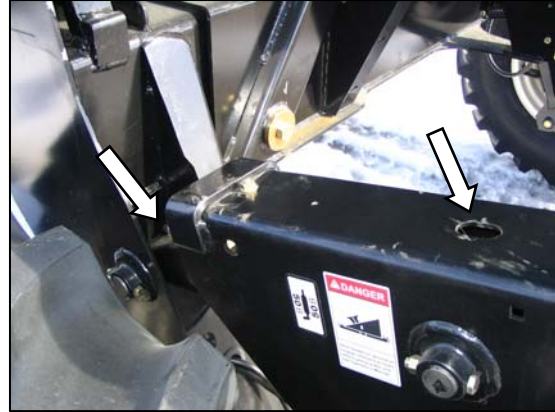

TOP LINK - TWO FITTINGS (BOTH SIDES)



FORMED CASTER WHEEL BEARING 1 PLACE (BOTH WHEELS)

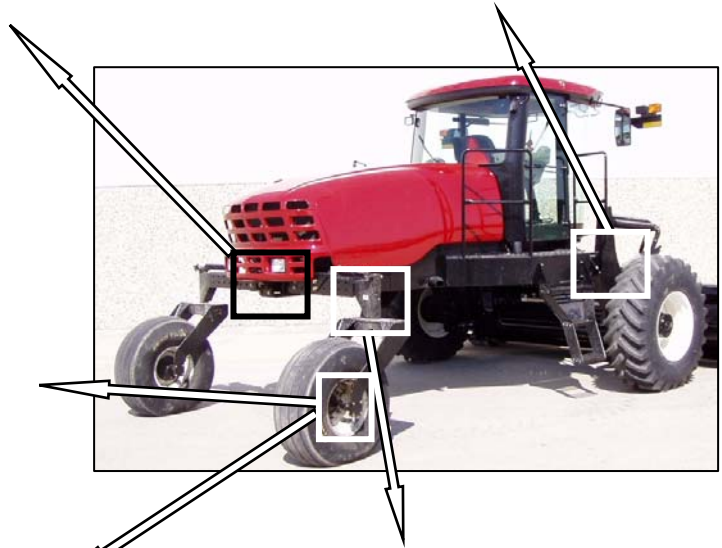

FORKED CASTER SPINDLE BEARINGS TWO PLACES (BOTH WHEELS)



CASTER PIVOT (BOTH SIDES)

UNLOADING AND ASSEMBLY

STEP 12. PROGRAM CAB DISPLAY MODULE (CDM)

The monitoring system requires programming for each header and the **header must be attached to the windrower** so that the CDM recognizes the type of header.

Programming the system may be accomplished with or without the engine running. If the engine is running, the transmission must be in neutral. If the engine is not running, the ignition must be on.

Exit programming mode at any time by pressing the PROGRAM switch or by turning off the ignition.

The system only needs to be programmed once for each header. The operator may make changes later on to a particular setting to suit windrowing conditions or modifications to the machine. Most functions have been pre-programmed at the factory but can be changed by the operator if required.

The following functions can be programmed by the dealer provided he has the applicable information from the operator and the header is installed:

- **DWA INSTALLED**
- **HDR CUT WIDTH**
- **HAY CONDITIONER INSTALLED**
- **CALIBRATE SENSORS**

Proceed as follows to program the CDM:

IMPORTANT

Header must be attached to the windrower so that the CDM can detect the type of header (Header ID), and adjust the programming mode accordingly.

- Turn ignition key to RUN, or start the engine.
- Press PROGRAM and SELECT switches together on CDM to enter programming mode. Header ID code is displayed.
- Press SELECT. TRACTOR SETUP? is displayed.
- Press \leftarrow . SET KNIFE SPEED? is displayed.
- Press SELECT until DWA INSTALLED? is displayed.
- Press \leftarrow or \rightarrow .
- Press SELECT to advance to the next L1 item.
- Press PROGRAM to exit programming mode.
- Refer to Detailed Programming Instructions on following pages.

NOTE

The functions requiring programming are highlighted with $\boxed{\text{---}}$ in the Programming Instructions.

NOTE

If necessary, refer to the M150, M200 Windrower Operator's Manual for programming CDM to specific crop types and conditions.

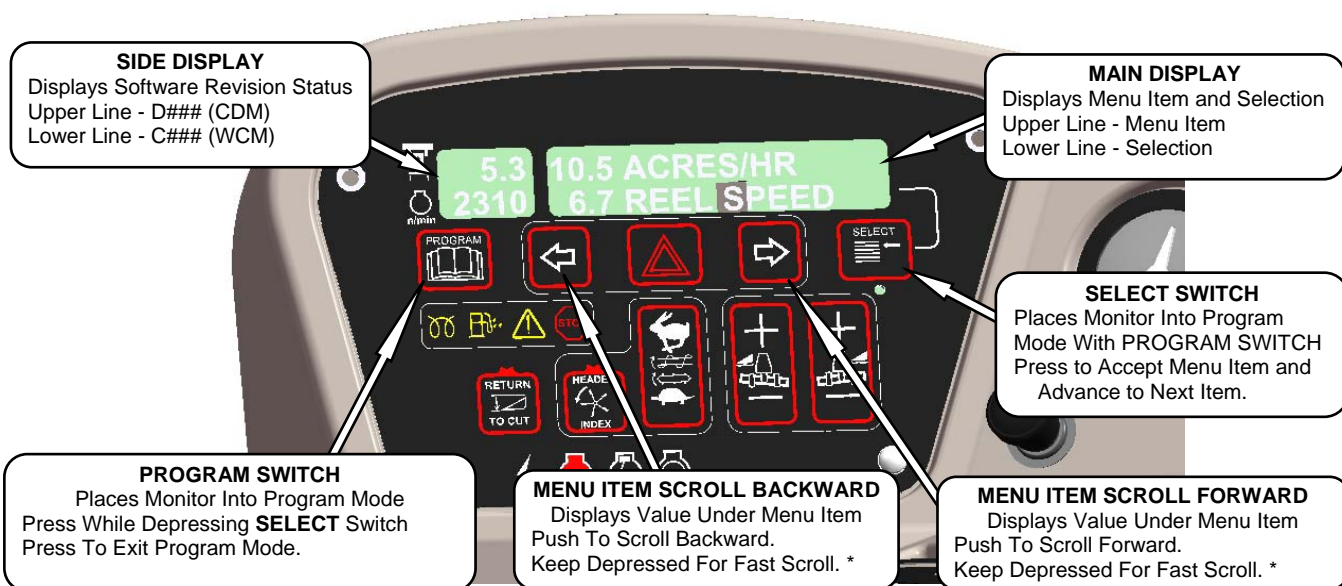

* Fast scroll applies only when changing KNIFE SPEED, OVERLOAD PRESSURE, and TIRE SIZE

UNLOADING AND ASSEMBLY

DETAILED PROGRAMMING INSTRUCTIONS

(Key On / Engine Running or Not / Header Disengaged).
 (Press **PROGRAM** and **SELECT** on CDM to enter programming mode).

Programming Menu Flow Chart

L1	D x x x TRACTOR SETUP?	If "NO" then jump to:
L2	C x x x ← NO / YES →	C A B D I S P L A Y S E T U P ?
L1	C x x x SET KNIFE SPEED?	When the programming mode is entered the header ID will be displayed on the top line of the CDM using the last 4 display positions. Pressing "SELECT" will go to the next line 1 (L1) menu selection. The turn signal "arrow" keys are used to change the values. Pressing "PROGRAM" at any time will cancel the programming mode / menus and return back to the main operating displays.
L2	M x x x ← 1 2 0 0 S P M →	
L1	C x x x KNIFE OVERLOAD SPD?	
L2	M x x x ← 1 0 0 0 S P M →	
L1	C x x x DISK OVERLOAD SPD?	
L2	M x x x ← 2 0 0 0 R P M →	
L1	C x x x OVERLOAD PRESSURE?	
L2	M x x x ← 4 0 0 0 P S I →	
L1	C x x x HEADER INDEX MODE?	
L2	M x x x ← REEL & CONVEYOR →	
L2	M x x x ← REEL ONLY →	
L1	C x x x RETURN TO CUT MODE?	The auto raise setting can be changed from 4.0 (min.) to 10.0 (max.) in 0.5 increments OFF disables the auto raise function.
L2	M x x x ← HEIGHT & TILT →	
L2	M x x x ← HEIGHT ONLY →	
L1	C x x x AUTO RAISE HEIGHT?	The auto raise setting can be changed from 4.0 (min.) to 10.0 (max.) in 0.5 increments OFF disables the auto raise function.
L2	M x x x ← - 4 . 0 + →	
L2	M x x x ← - OFF + →	
L1	C x x x DWA INSTALLED?	If "NO" then jump to:
L2	M x x x ← NO / YES →	H E A D E R C U T W I D T H ?
L1	C x x x SWAP DWA CONTROLS?	Swaps the GSL reel fore / aft with the DWA console controls. If NO jump to DWA AUTO UP & DOWN?
L2	M x x x ← NO / YES →	
L1	C x x x DWA AUTO UP / DOWN?	Enables the express up and down feature with the header RTC. If NO jump to HEADER CUT WIDTH?
L2	M x x x ← NO / YES →	
L1	C x x x TILT CYL INSTALLED?	Appears for M150 ONLY - If "NO" then jump to:
L2	M x x x ← NO / YES →	H E A D E R C U T W I D T H ?
L1	C x x x DISC BLK INSTALLED?	If "NO" then jump to:
L2	M x x x ← NO / YES →	H E A D E R C U T W I D T H ?
L1	C x x x HDR CUT WIDTH? 0101	Use the "arrow" keys to set the header cut width. The header ID appears at the RHS.
L2	M x x x ← 2 0 . 5 F E E T →	
L1	C x x x HAY CONDITIONER?	DRAPER HEADER ONLY. Default will be flashing. Use "arrow" keys to select.
L2	M x x x ← NO / YES →	
L1	C x x x AUGER HDR REEL SPD	A U G E R H E A D E R O N L Y
L2	M x x x ← RPM / MPH →	F o r I M P E R I A L d i s p l a y .
L2	M x x x ← RPM / KPH →	F o r M E T R I C d i s p l a y .
L1	C x x x SET TIRE SIZE?	Pressing "SELECT" will go to the next line 1 (L1) menu selection. The turn signal "arrow" keys are used to change the values.
L2	M x x x ← 1 8 . 4 X 2 6 T U R F →	
L2	M x x x ← 1 8 . 4 X 2 6 B A R →	
L2	M x x x ← 2 3 . 1 X 2 6 T U R F →	
L2	M x x x ← 6 0 0 - 6 5 R 2 8 →	
L2	M x x x ← 5 8 0 / 7 0 R 2 6 T U R F →	
L1	C x x x SET ENGINE ISC RPM?	If "NO" then jump to:
L2	M x x x ← NO / YES →	S E T C O N T R O L L O C K S ?
L1	C x x x PRESS HAZARD TO SET	This is used to set the Intermediate Speed Control function for the engine. The default or last selected rpm will be displayed first and will be flashing. The "arrow" keys are used to cycle between the selections. When "SELECT" is pressed the program goes to the EXIT ENGINE ISC? menu selection.
L2	M x x x ISC RPM OFF →	
L1	C x x x PRESS HAZARD TO SET	
L2	M x x x ISC RPM 2 0 0 0 →	
L1	C x x x PRESS HAZARD TO SET	
L2	M x x x ISC RPM 1 9 0 0 →	
L1	C x x x PRESS HAZARD TO SET	If "NO" then jump to:
L2	M x x x ISC RPM 1 8 0 0 →	
L1	C x x x EXIT ENGINE ISC?	P R E S S H A Z A R D T O S E T
L2	M x x x ← NO / YES →	

(continued next page)

UNLOADING AND ASSEMBLY

L1	C x x x SET CONTROL LOCKS?	If "NO" then jump to:
L2	M x x x ← NO / YES →	VIEW CONTROL LOCKS?

L1	C x x x HEADER TILT	<div style="border: 1px solid black; padding: 5px;"> <p>This menu allows the operator to selectably "lock out" the control functions for the various header functions. The default or selected "status" for each item will flash.</p> <p>The "arrow" keys are used to ENABLE or LOCK OUT each function. Pressing "SELECT" will go to the next L1 menu item.</p> </div>	
L2	M x x x ← ENABLED / LOCKED →		
L1	C x x x HEADER FLOAT		
L2	M x x x ← ENABLED / LOCKED →		
L1	C x x x REEL FORE / AFT		
L2	M x x x ← ENABLED / LOCKED →		
L1	C x x x DRAPER SPEED		
L2	M x x x ← ENABLED / LOCKED →		
L1	C x x x AUGER SPEED		
L2	M x x x ← ENABLED / LOCKED →		
L1	C x x x KNIFE SPEED	<div style="border: 1px solid black; padding: 5px;"> <p>When the control lock outs are viewed the lower display line (L2) will show the engine hours and either ENABLED or LOCKED to indicate the present status along with the engine hours at which time the function was either ENABLED or LOCKED.</p> <p>Using the "arrow" keys allows the operator to select the various functions. Pressing "SELECT" will go to the EXIT VIEW LOCKOUTS? menu selection.</p> </div>	
L2	M x x x ← ENABLED / LOCKED →		
or L1	C x x x DISK SPEED		
L2	M x x x ← ENABLED / LOCKED →		
L1	C x x x REEL SPEED		
L2	M x x x ← ENABLED / LOCKED →		
L1	C x x x EXIT CONTROL LOCKS?		
L2	M x x x ← NO / YES →		
L1	C x x x VIEW CONTROL LOCKS?		If "NO" then jump to:
L2	M x x x ← NO / YES →		EXIT TRACTOR SETUP?

L1	C x x x HEADER TILT	<div style="border: 1px solid black; padding: 5px;"> <p>When the control lock outs are viewed the lower display line (L2) will show the engine hours and either ENABLED or LOCKED to indicate the present status along with the engine hours at which time the function was either ENABLED or LOCKED.</p> <p>Using the "arrow" keys allows the operator to select the various functions. Pressing "SELECT" will go to the EXIT VIEW LOCKOUTS? menu selection.</p> </div>
L2	M x x x 5 7 5 . 1 HRS ENABLED	
L2	M x x x 6 4 8 . 6 HRS LOCKED	
L1	C x x x HEADER FLOAT	
L2	M x x x 5 7 5 . 1 HRS ENABLED	
L2	M x x x 6 4 8 . 6 HRS LOCKED	
L1	C x x x REEL FORE / AFT	
L2	M x x x 5 7 5 . 1 HRS ENABLED	
L2	M x x x 6 4 8 . 6 HRS LOCKED	
L1	C x x x DRAPER SPEED	
L2	M x x x 5 7 5 . 1 HRS ENABLED	
L2	M x x x 6 4 8 . 6 HRS LOCKED	
L1	C x x x AUGER SPEED	<div style="border: 1px solid black; padding: 5px;"> <p>When the control lock outs are viewed the lower display line (L2) will show the engine hours and either ENABLED or LOCKED to indicate the present status along with the engine hours at which time the function was either ENABLED or LOCKED.</p> <p>Using the "arrow" keys allows the operator to select the various functions. Pressing "SELECT" will go to the EXIT VIEW LOCKOUTS? menu selection.</p> </div>
L2	M x x x 5 7 5 . 1 HRS ENABLED	
L2	M x x x 6 4 8 . 6 HRS LOCKED	
L1	C x x x KNIFE SPEED	
L2	M x x x 5 7 5 . 1 HRS ENABLED	
L2	M x x x 6 4 8 . 6 HRS LOCKED	
L1	C x x x DISK SPEED	
L2	M x x x 5 7 5 . 1 HRS ENABLED	
L2	M x x x 6 4 8 . 6 HRS LOCKED	
L1	C x x x REEL SPEED	
L2	M x x x 5 7 5 . 1 HRS ENABLED	
L2	M x x x 6 4 8 . 6 HRS LOCKED	
L1	C x x x EXIT VIEW LOCKOUTS?	If "NO" then jump to:
L2	M x x x ← NO / YES →	HEADER TILT ← →

L1	C x x x EXIT TRACTOR SETUP?	If "NO" then jump to:
L2	M x x x ← NO / YES →	SET KNIFE SPEED?

(continued next page)

UNLOADING AND ASSEMBLY

L1 **C** x x x || **CAB DISPLAY SETUP?**
L2 **M** x x x || ← **NO / YES** →

If "NO" then jump to:

CALIBRATE SENSORS?



L1 **C** x x x || **DISPLAY LANGUAGE?**
L2 **M** x x x || ← **ENGLISH** →
L2 **M** x x x || ← **ESPAÑOL** →

Use the "arrow" keys to change the default language. Pressing "SELECT" goes to the next L1 menu selection.

L1 **C** x x x || **DISPLAY UNITS?**
L2 **M** x x x || ← **IMPERIAL** →
L2 **M** x x x || ← **METRIC** →

The "arrow" keys are used to select between IMPERIAL or METRIC. The default value will be displayed first.

L1 **C** x x x || **CDM BUZZER VOLUME**
L2 **M** x x x || ← [Bar Graph] →

The "arrow" keys are used to change the CDM buzzer volume, CDM backlighting or the CDM contrast, with the bar graph indicating the relative level for each item. When "SELECT" is pressed the program goes to the EXIT DISPLAY SETUP? menu selection.

L1 **C** x x x || **CDM BACKLIGHTING**
L2 **M** x x x || ← [Bar Graph] →

L1 **C** x x x || **CDM CONTRAST**
L2 **M** x x x || ← [Bar Graph] →

If "NO" then jump to:

DISPLAY LANGUAGE?

L1 **C** x x x || **CALIBRATE SENSORS?**
L2 **M** x x x || ← **NO / YES** →

If "NO" then jump to:

DIAGNOSTIC MODE?



L1 **C** x x x || **TO CALIBRATE SELECT**
L2 **M** x x x || ← **HEADER HEIGHT** →
L2 **M** x x x || ← **HEADER TILT** →
L2 **M** x x x || ← **HEADER FLOAT** →
L2 **M** x x x || **EXIT CAL?** ← **NO / YES** →

The operator can select any of the three items requiring calibration (or exit the CAL menu) by using the turn signal switches to cycle through the choices. Pressing SELECT will take the operator to the calibration menu for that particular sensor.

L1 **C** x x x || **HEIGHT SENSOR CAL**
L2 **M** x x x || **RAISE HDR TO START**

The display will indicate the sensor being calibrated. The operator will be prompted to raise the header and HOLD will flash until the system has completed reading in the signal with the header fully raised. HOLD will change to DONE (with buzzer).

L1 **C** x x x || **CALIBRATING HEIGHT**
L2 **M** x x x || **RAISE HEADER HOLD**
L2 **M** x x x || **HEADER RAISE DONE**

When the header raise is done, the CDM will prompt the user to lower the header. COMPLETE (with buzzer) will flash on the screen for 2 seconds when the calibration is finished.

L1 **C** x x x || **CALIBRATING HEIGHT**
L2 **M** x x x || **LOWER HEADER HOLD**
L2 **M** x x x || **HT SENSOR COMPLETE**

L1 **C** x x x || **TO CALIBRATE SELECT**
L2 **M** x x x || ← **HEADER HEIGHT** →
L2 **M** x x x || ← **HEADER TILT** →
L2 **M** x x x || ← **HEADER FLOAT** →
L2 **M** x x x || **EXIT CAL?** ← **NO / YES** →

The operator can select any of the three items requiring calibration (or exit the CAL menu) by using the turn signal switches to cycle through the choices. Pressing SELECT will take the operator to the calibration menu for that particular sensor.

L1 **C** x x x || **HDR TILT SENSOR CAL**
L2 **M** x x x || **EXTEND TILT TO START**

The display will indicate the sensor being calibrated. The operator will be prompted to extend the header tilt and HOLD will flash until the system has completed reading in the signal with the header tilt fully extended. HOLD will change to DONE (with buzzer).

L1 **C** x x x || **CALIBRATING TILT**
L2 **M** x x x || **EXTEND TILT HOLD**
L2 **M** x x x || **EXTEND TILT DONE**

When the header tilt extend is done, the CDM will prompt the user to press the header tilt retract. COMPLETE (with buzzer) will flash on the screen for 2 seconds when the calibration is finished.

L1 **C** x x x || **CALIBRATING TILT**
L2 **M** x x x || **RETRACT TILT HOLD**
L2 **M** x x x || **HDR TILT COMPLETE**

L1 **C** x x x || **TO CALIBRATE SELECT**
L2 **M** x x x || ← **HEADER HEIGHT** →
L2 **M** x x x || ← **HEADER TILT** →
L2 **M** x x x || ← **HEADER FLOAT** →
L2 **M** x x x || **EXIT CAL?** ← **NO / YES** →

The operator can select any of the three items requiring calibration (or exit the CAL menu) by using the turn signal switches to cycle through the choices. Pressing SELECT will take the operator to the calibration menu for that particular sensor.

L1 **C** x x x || **CALIBRATING FLOAT**
L2 **M** x x x || **PRESS FLT + TO START**

The display will indicate the sensor being calibrated. The operator will be prompted to press the float (+) and HOLD will flash until the system has completed reading in the signal with the header float fully extended. HOLD will change to DONE (with buzzer).

L1 **C** x x x || **CALIBRATING FLOAT**
L2 **M** x x x || **FLOAT (+) HOLD**
L2 **M** x x x || **FLOAT (+) DONE**

When the header float (+) is done, the CDM will prompt the user to press the header float (-). COMPLETE (with buzzer) will flash on the screen for 2 seconds when the calibration is finished.

L1 **C** x x x || **CALIBRATING FLOAT**
L2 **M** x x x || **FLOAT (-) HOLD**
L2 **M** x x x || **HDR FLOAT COMPLETE**

(continued next page)

UNLOADING AND ASSEMBLY

L2 L2 L2 L1 L2	C x x x TO CALIBRATE SELECT M x x x ← HEADER HEIGHT → M x x x ← HEADER TILT → M x x x ← HEADER FLOAT → M x x x EXIT CAL? ← NO / YES →	Select any of the sensors by using the turn signal switches to cycle through the choices. Pressing SELECT will take the operator to the calibration menu for that particular sensor. NO is the default for EXIT CAL?. If "NO" then jump to: TO CALIBRATE SELECT
L1 L2	C x x x DIAGNOSTIC MODE? If "NO" then jump to: M x x x ← NO / YES → TRACTOR SETUP?	
L1 L2	C x x x VIEW ERROR CODES? If "NO" then jump to: M x x x ← NO / YES → ENTER SENSOR SETUP?	
L1 L2	C x x x VIEW TRACTOR CODES? If "NO" then jump to: M x x x ← NO / YES → VIEW ENGINE CODES?	
L1 L2	1 1 2 3 4 . 5 HRS 1 2 3 ← → E 4 7 SENSOR VOLTS LOW	The last 10 distinct error codes are stored along with the code #, Exxx, engine hours and number of occurrences. The "arrow" keys are used to cycle between codes.
L1 L2	2 1 2 3 0 . 5 HRS 1 2 3 ← → E 7 1 LOW HYDRAULIC OIL	If "NO" then jump to the first error code logged.
L1 L2	C x x x EXIT TRACTOR CODES? M x x x ← NO / YES →	If "NO" then jump to: ENTER SENSOR SETUP?
L1 L2	C x x x VIEW ENGINE CODES? M x x x ← NO / YES →	The last 10 distinct error codes are stored.
L1 L2	1 1 2 3 4 . 5 HRS 1 2 3 ← → 4 4 9 FUEL PRESSURE HIGH	If "NO" then jump to the first engine error code logged.
L1 L2	C x x x EXIT ENGINE CODES? M x x x ← NO / YES →	If "NO" then jump to: VIEW TRACTOR CODES?
L1 L2	C x x x EXIT ERROR CODES? M x x x ← NO / YES →	
L1 L2	C x x x ENTER SENSOR SETUP? If "NO" then jump to: M x x x ← NO / YES → READ SENSOR INPUTS?	
L1 L2	C x x x KNIFE SPEED SENSOR M x x x ← ENABLE / DISABLE →	The operator can select each sensor and selectively enable or disable the sensor. This can be used to disable a failed sensor to eliminate false or erratic display readings. When "SELECT" is pressed the program goes to the EXIT SENSOR SETUP? menu selection.
L1 L2	C x x x REEL SPEED SENSOR M x x x ← ENABLE / DISABLE →	
L1 L2	C x x x HEADER HT SENSOR M x x x ← ENABLE / DISABLE →	
L1 L2	C x x x HEADER TILT SENSOR M x x x ← ENABLE / DISABLE →	
L1 L2	C x x x HEADER FLOAT SENSOR M x x x ← ENABLE / DISABLE →	
L1 L2	C x x x OVERLOAD PRESSURE M x x x ← ENABLE / DISABLE →	
L1 L2	C x x x HYD OIL TEMP SENSOR M x x x ← ENABLE / DISABLE →	
L1 L2	C x x x EXIT SENSOR SETUP? M x x x ← NO / YES →	
L1 L2	C x x x READ SENSOR INPUTS? If "NO" then jump to: M x x x ← NO / YES → ACTIVATE FUNCTIONS?	
L1 L2	C x x x SENSOR INPUT ← → M x x x HDR HEIGHT 3 . 5 9 V	For diagnostic purposes each sensors input signal can be read. This helps in determining how each sensor is operating and if the proper output voltages are being received by the control system.
L1 L2	C x x x SENSOR INPUT ← → M x x x HDR ANGLE 1 . 8 4 V	
L1 L2	C x x x SENSOR INPUT ← → M x x x 2 . 4 5 V FLOAT 2 . 8 4 V	
L1 L2	C x x x SENSOR INPUT ← → M x x x KNIFE SPEED 1 2 3 HZ	
L1 L2	C x x x SENSOR INPUT ← → M x x x REEL SPEED 1 2 3 HZ	When "SELECT" is pressed the program goes to the EXIT READ SENSORS? menu selection.
L1 L2	C x x x SENSOR INPUT ← → M x x x WHEEL SPEED 1 2 3 HZ	
L1 L2	C x x x SENSOR INPUT ← → M x x x HYD OIL TEMP 1 . 0 0 V	
L1 L2	C x x x EXIT READ SENSORS? M x x x ← NO / YES →	

(continued next page)

UNLOADING AND ASSEMBLY

```

L1 | C x x x || SENSOR INPUT | | ← →
L2 | M x x x || HDR HEIGHT | | SENSOR

L1 | C x x x || SENSOR INPUT | | ← →
L2 | M x x x || HDR ANGLE | | SENSOR

L1 | C x x x || SENSOR INPUT | | ← →
L2 | M x x x || 2.45 V FLOAT | | SENSOR

L1 | C x x x || SENSOR INPUT | | ← →
L2 | M x x x || KNIFE SPEED | | SENSOR

L1 | C x x x || SENSOR INPUT | | ← →
L2 | M x x x || REEL SPEED | | SENSOR

L1 | C x x x || SENSOR INPUT | | ← →
L2 | M x x x || HYD OIL TEMP | | SENSOR
    
```

If a sensor has been disabled "SENSOR" will be flashing in the area where the input reading would have been.

```

L1 | C x x x || ACTIVATE FUNCTIONS? | | If "NO" then jump to:
L2 | M x x x || ← NO / YES → | | FORCE HEADER TYPE?
    
```

```

L1 | C x x x || ACTIVATE FUNCTIONS?
L2 | M x x x || HEADER ← DOWN / UP →

L1 | C x x x || ACTIVATE FUNCTIONS?
L2 | M x x x || REEL ← DOWN / UP →

L1 | C x x x || ACTIVATE FUNCTIONS?
L2 | M x x x || HDR TILT ← IN / OUT →

L1 | C x x x || ACTIVATE FUNCTIONS?
L2 | M x x x || KNIFE DRIVE ON →

L1 | C x x x || ACTIVATE FUNCTIONS?
L2 | M x x x || DRAPER / AUGER ON →

L1 | C x x x || ACTIVATE FUNCTIONS?
L2 | M x x x || REEL ← FORE / AFT →

L1 | C x x x || ACTIVATE FUNCTIONS?
L2 | M x x x || DWA DRIVE ON →

L1 | C x x x || ACTIVATE HYD PURGE?
L2 | M x x x || ← NO / YES →

L1 | C x x x || TO ACTIVATE PURGE
L2 | M x x x || PRESS AND HOLD →

L1 | C x x x || PURGE CYCLE STARTED
L2 | M x x x || PRESS AND HOLD →

L1 | C x x x || PURGE CYCLE ENDED
L2 | M x x x ||

L1 | C x x x || PURGE CYCLE ENDED
L2 | M x x x || ← NO EXIT YES →

L1 | C x x x || EXIT FUNCTION MENU?
L2 | M x x x || ← NO / YES →
    
```

For diagnostic purposes each header function can be activated by using the "arrow" keys on the CDM. When "SELECT" is pressed the program will go to the next function that can be activated.

If a disk header is detected then the nomenclature should read: DISC DRIVE instead of KNIFE DRIVE.

PWM OPERATION: If the HAZARD switch is pressed instead of the TURN SIGNAL switch the GSL will operate the PWM valve (HAZARD sw must be held) and the PWM value will reset to zero when released.

The DWA menu selection should only be available if the DWA INSTALLED? is set to YES.

ACTIVATE HYD PURGE - This is to allow the operator to purge the air from a new or changed pump system.

Pressing and holding the right hand "arrow" button activates a predetermined timed purge cycle. Releasing pressure on the switch or a completed cycle (timed out) will jump to the PURGE CYCLE ENDED menu selection.

If "NO" then jump to:
HEADER ← **DOWN / UP** →

```

L1 | C x x x || FORCE HEADER TYPE? | | If "NO" then jump to:
L2 | M x x x || ← NO / YES → | | EXIT DIAGNOSTICS?
    
```

```

L1 | C x x x || SELECT HEADER TYPE
L2 | M x x x || ← DISK HEADER →
L2 | M x x x || ← SK AUGER →
L2 | M x x x || ← DK AUGER →
L2 | M x x x || ← GRASS SEED →
L2 | M x x x || ← 20 FT SK DRAPER →
L2 | M x x x || ← 25 FT SK DRAPER →
L2 | M x x x || ← 30 FT SK DRAPER →
L2 | M x x x || ← 35 FT SK DRAPER →
L2 | M x x x || ← 15 FT DK DRAPER →
L2 | M x x x || ← 20 FT DK DRAPER →
L2 | M x x x || ← 25 FT DK DRAPER →
L2 | M x x x || ← 30 FT DK DRAPER →
L2 | M x x x || ← 35 FT DK DRAPER →
L2 | M x x x || ← 40 FT DK DRAPER →

L1 | C x x x || EXIT HEADER TYPE?
L2 | M x x x || ← NO / YES →

L1 | C x x x || EXIT DIAGNOSTICS?
L2 | M x x x || ← NO / YES →
    
```

This allows the operator to select or "force" a header ID configuration if a "NO HEADER" ID is being read by the control system. The header type will revert back to "NO HEADER" every time the ignition is cycled.

When "SELECT" is pressed the program goes to the EXIT HEADER TYPE? menu selection.

If "NO" then jump to:
FORCE HEADER TYPE?

If "NO" then jump to:
DIAGNOSTIC MODE?

PRE-DELIVERY CHECKS

STEP 13. PERFORM PRE-DELIVERY CHECKS



WARNING

Stop windrower engine and remove key before making adjustments to machine. A child or even a pet could engage the drive.

- a. Perform the final checks and adjustments as listed on the "Pre-Delivery Checklist" (yellow sheet) to ensure the machine is field-ready. Refer to the following pages for detailed instructions as indicated on the checklist.
- b. The completed checklist should be retained either by the Operator or the Dealer.

A. FINAL DRIVE LUBRICANT LEVEL

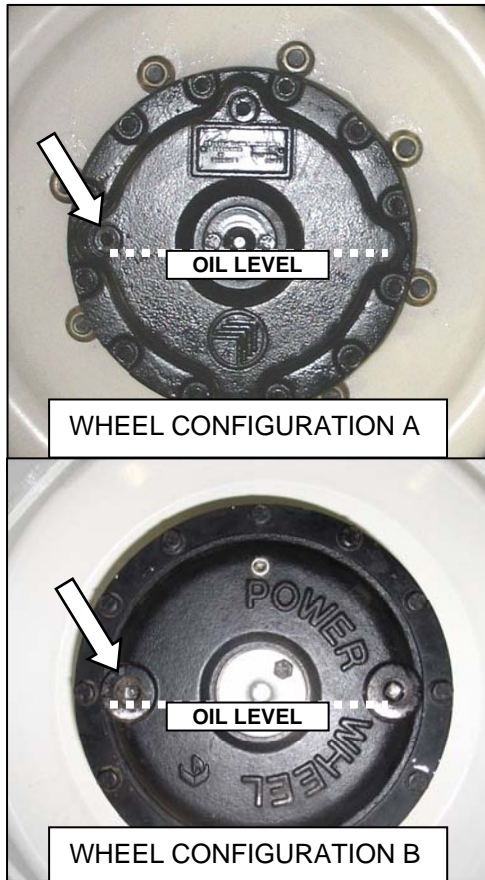

- a. Rotate wheel so that one of the plugs is horizontally aligned with the center of the hub.
- b. Remove the plug. The oil should be visible through the hole or slightly running out.

B. TIRE PRESSURES AND BALLAST REQUIREMENTS

I. TIRE PRESSURES

Measure tire pressure with a gauge.

- Bar - 32 psi (221 kPa)
- Turf - 20 psi (138 kPa)
- Caster - 10 psi (69 kPa)

II. BALLAST REQUIREMENTS

Fluid ballasting of rear caster tires is recommended to provide adequate machine stability when using large headers on the windrower.

Also, the stability of machine varies with different attachments, windrower options, terrain and Operator's driving technique.

Ballast capability per tire is at a maximum fill of 75%, or when fluid is level with valve stem when the stem is positioned at the "12 o'clock" position.

Fluid can be added to any level up to maximum fill, and always add an equal amount of fluid on both sides.

TIRE SIZE	FLUID PER TIRE AT 75% FILL U.S. Gal. (Liters)	TOTAL WEIGHT OF BOTH TIRES lb (kg) *
7.5X16 (A)	10 (38)	200 (91)
10X16 (B)	18 (69)	380 (170)
16.5X16.1 (C)	41 (158)	830 (377)

* Weights are given for typical calcium chloride and water mixtures. Weight is reduced by 20% if only water is used (for areas that do not require anti-freeze protection).

(continued next page)

PRE-DELIVERY CHECKS

HEADER DESCRIPTION		RECOMMENDED BALLAST				RECOMMENDED TIRE SIZE	APPLICABLE WINDROWER
		LEVEL GROUND		HILLS			
TYPE	SIZE	PER TIRE	BOTH TIRES	PER TIRE	BOTH TIRES		
		U.S. Gal. (Liters)	lb (kg) *	U.S. Gal. (Liters)	lb (kg) *		
A, D, R Series All Options	25' and Down	0	0	0	0	A, B, C	M150, M200
D Series	30' Single Or Split Reel W/O Conditioner	0	0	10 (38)	200 (91)	A, B, C	M150, M200
	35' Single Reel						
	30' Split Reel. Steel Fingers and Conditioner	18 (69)	380 (170)	30 (115)	630 (288)	Level Ground - B, C	M150, M200
	35' Split Reel (5 Or 6 Bat)					Hills - C	
	40'	30 (115)	630 (288)	41 (158)	830 (377)	C	M150, M200

** If only water is used, increase volume of water by 20% (up to maximum allowable fill per tire) to compensate.*

C. ENGINE COOLANT



- a. Check daily the coolant level in the coolant recovery tank. Tank should be at least half full.
- b. Check coolant concentration in the radiator. Coolant shall be good for temperatures of -30°F (-34°C).

PRE-DELIVERY CHECKS

D. AIR CLEANER

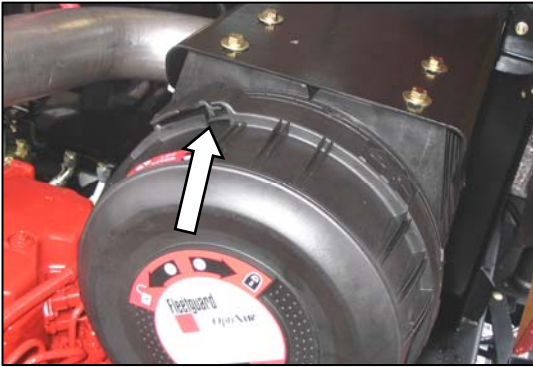

- Check that air cleaner cap is firmly attached, and that all clamps are secure.



- Check spring clamp at back of air cleaner.

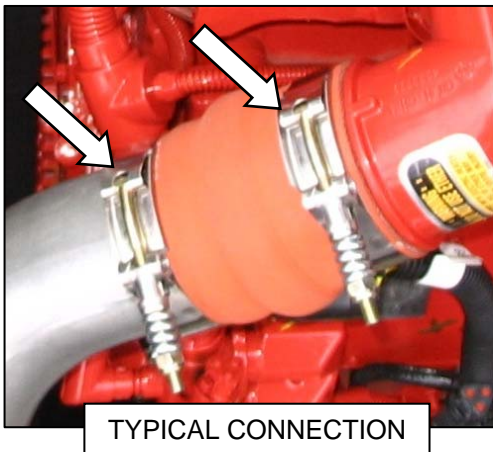

- Check spring clamps on charge air cooling duct connections (at turbocharger outlet, engine intake, and inside cooling box).

E. HYDRAULIC OIL LEVEL



- Turn filler cap counter clockwise to loosen bung, and remove dipstick.

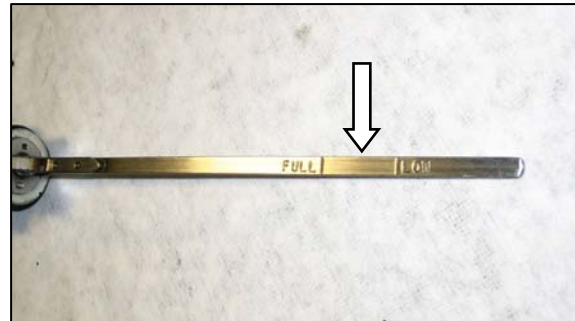

- Check that level is between LOW and FULL marks.
- Reinstall dipstick, and turn clockwise to tighten bung.

PRE-DELIVERY CHECKS

F. FUEL SEPARATOR

- a. Place a container under filter drain.

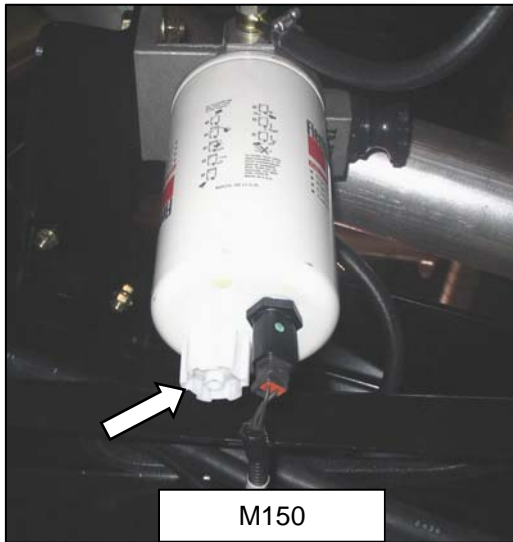

- b. Turn drain valve by hand $1\frac{1}{2}$ to 2 turns counter clockwise, until draining occurs.
- c. Drain the filter sump of water and sediment until clear fuel is visible. Clean as necessary.
- d. Turn the valve clockwise to close the drain.
- e. Safely dispose of fluid.

G. GEAR BOX LUBRICANT LEVEL

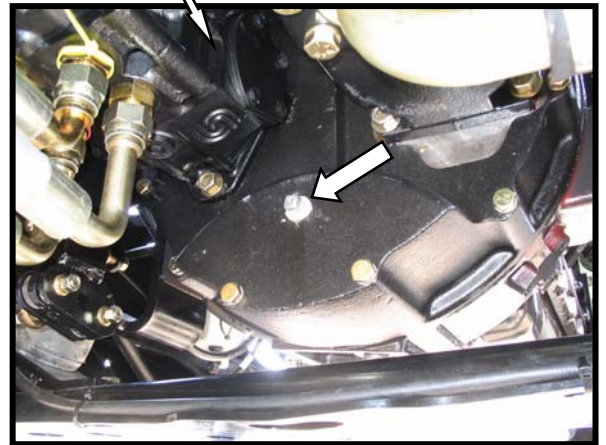
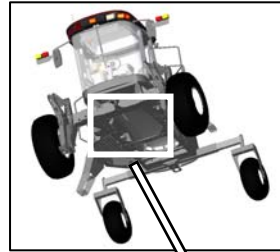

- a. Remove plug. The lubricant should be visible through the hole, or slightly running out.
- b. Replace plug, and tighten.

H. A/C COMPRESSOR BELT



- a. Tension on A/C compressor belt should be such that a force of 8 to 12 lbf (35 - 55 N) deflects the belt $\frac{3}{16}$ inch (5 mm) at mid-span.

PRE-DELIVERY CHECKS

I. PERFORM SAFETY SYSTEM CHECKS



CAUTION

Check to be sure all bystanders have cleared the area.

A properly functioning system should operate as follows:

- The starter should engage ONLY when the GSL is in N-DETENT, steering wheel locked in the CENTER position, and the header drive switch is in the OFF position.
- Under the above conditions, the brake should engage, and the machine should not move after engine start-up.
- The steering wheel should not lock with the engine running, and the GSL is out of the N-DETENT.
- The machine should not move with the engine running, and with the steering wheel still centered, when the GSL is pulled straight out of N-DETENT (not in forward or reverse).

If the system does not function as described above, refer to the Technical Service Manual.

- a. With the engine shut down and the header drive switch engaged, try to start the engine. The CDM will display "HEADER ENGAGED" on the upper line, and "DISENGAGE HEADER" on the lower line.

If the engine turns over, the system requires adjustment. Refer to the Technical Service Manual.

- b. With the engine shut down, do the following:
1. Open engine compartment hood.

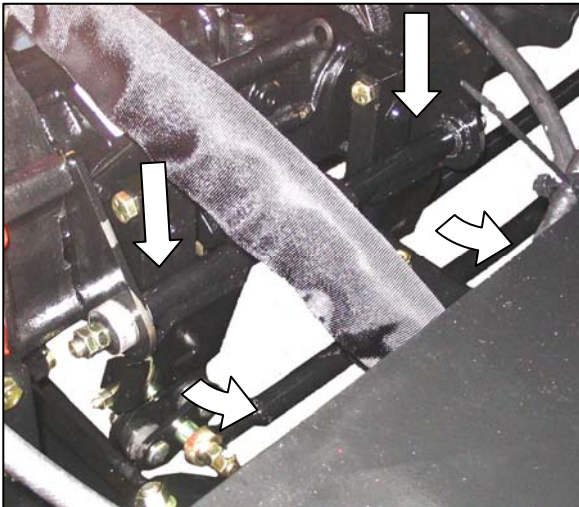

2. Pry the steering interlock away from pintle arms by inserting a wedge or pry bar between one of the interlock channels and pintle arm.
3. Insert a wood block approximately ¾ inch (19 mm) thick between the other channel and pintle arm, so that the interlock channel is clear of the pintle arm.
4. Turn the steering wheel off center, and move the GSL in N-DETENT.
5. Try to start the engine. The CDM will flash "CENTER STEERING", accompanied by a short beep with each flash, and the engine should not turn over.

If the engine turns over, the system requires adjustment. Refer to the Technical Service Manual.

6. Remove key.
7. Remove wood block inserted at step 3 above and close hood.



CAUTION

Check to be sure all bystanders have cleared the area.

- c. With the engine shut down, steering wheel centered, and the GSL in Neutral but not in N-DETENT;

1. Try to start the engine. The CDM will flash "CENTER STEERING" on the upper line, and "PLACE GSL INTO N" on the lower line accompanied by a short beep with each flash, and the engine should not turn over.

If the engine turns over, the system requires adjustment. Refer to the Technical Service Manual.

- d. With the engine shut down, steering wheel centered, GSL in N-DETENT, operator's station not locked;

1. Try to start the engine. Engine will crank but will not start. The CDM will display "SEAT BASE NOT LOCKED".

If engine starts, the system requires adjustment. Refer to the Technical Service Manual.

PRE-DELIVERY CHECKS

J. OPERATIONAL CHECKS

I. ENGINE WARNING LIGHTS

- Turn ignition key to RUN position.
- Single loud tone sounds, and engine warning lights illuminate briefly.

II. START ENGINE

- Check fuel level, and if required add sufficient fuel for a 15 minute run.



- Operator's station lock (A) must be engaged at cab-forward or engine-forward position.
- Move GSL (B) into N-DETENT.
- Turn steering wheel until it locks.

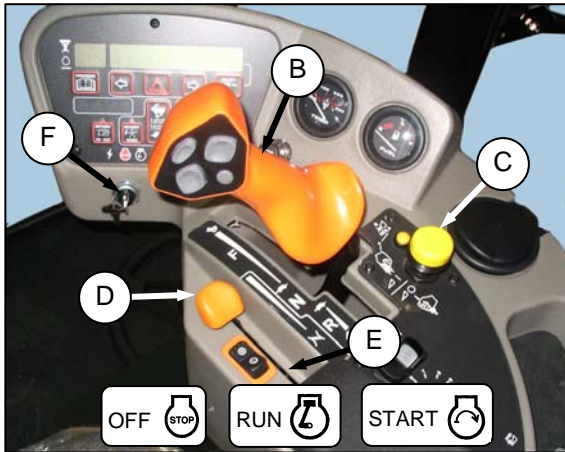

- Push header drive switch (C) to off.
- Normal Start** - engine temperature above 60°F (16°C):
 - Set throttle (D) to start position (E) - fully back.
 - Sound horn three times.
 - Turn ignition key (F) to RUN position.
 - Single loud tone sounds, engine warning lights illuminate briefly, and CDM displays HEADER DISENGAGED or DISENGAGE HEADER and IN PARK.



CAUTION

Check to be sure all bystanders have cleared the area.

- Turn ignition key to START position until engine starts, and then release key. CDM displays programmed header data for 5 seconds if attached, and then returns to previous display.

IMPORTANT

Do not operate starter for longer than 15 seconds at a time.

If engine does not start, wait at least two minutes before trying again.

After the third 15 second crank attempt, allow starter to cool for 10 minutes before further cranking attempts.

If engine still does not start, refer to the following table:

PROBLEM	SOLUTION
Controls not in neutral.	Move GSL to neutral. Move steering wheel to locked position. Disengage header clutch.
Operator's station not locked.	Adjust position of Operator's station. Ensure lock is engaged.
Neutral interlock misadjusted.	Contact MacDon Dealer.
No fuel to engine.	Fill empty fuel tank. Replace clogged filter.
Old fuel in tank.	Drain tank, refill with fresh fuel.
Water, dirt or air in fuel system.	Drain, flush, fill and prime system.
Improper type of fuel.	Use proper fuel for operating conditions.
Crankcase oil too heavy.	Use recommended oil.
Low battery output.	Have battery tested. Check battery electrolyte level.
Battery disconnect switch is off.	Turn on battery switch.
Poor battery connection.	Clean and tighten loose connections.
Faulty starter.	Contact MacDon Dealer.
Wiring shorted, circuit breaker open.	Check continuity of wiring and breaker (manual reset).
Faulty injectors.	Contact MacDon Dealer.

(continued next page)

PRE-DELIVERY CHECKS

- g. **Cold Start** - engine temperature below 40°F (5°C).

M200 - CAT ENGINE

1. Set throttle (D) to start position (E) - fully back (low idle).
2. Sound horn three times.
3. Turn key to RUN.
4. Single loud tone sounds, engine warning lights illuminate, and CDM displays HEADER DISENGAGED or DISENGAGE HEADER and IN PARK.
5. Glow plug light on CDM will cycle on/off/on after 2 seconds for a pre-set length of time. The operating period for the glow plug light will change depending engine temperature.



CAUTION

Check to be sure all bystanders have cleared the area.

6. When glow plug light goes out, turn key to START, and crank engine until it starts. Leave throttle at IDLE.

IMPORTANT

If engine fails to start within 30 seconds, cease cranking, and wait two minutes to allow the starting motor to cool before attempting to re-start the engine.

7. If engine fails to start, repeat steps 1 to 4.
8. Engine will cycle through a period where it appears to labour.

M150 - CUMMINS ENGINE

1. Follow procedure for Normal Start.
2. Engine will cycle through a period where it appears to labour until engine warms up.

NOTE

Throttle is non-responsive during this time as engine is in "WARM UP" mode. This mode will last from 30 seconds to 3 minutes depending on temperature. After engine has stabilized and idling normally, throttle becomes active.

IMPORTANT

Do not operate engine above 1500 rpm until engine temperature gauge is above 100°F.

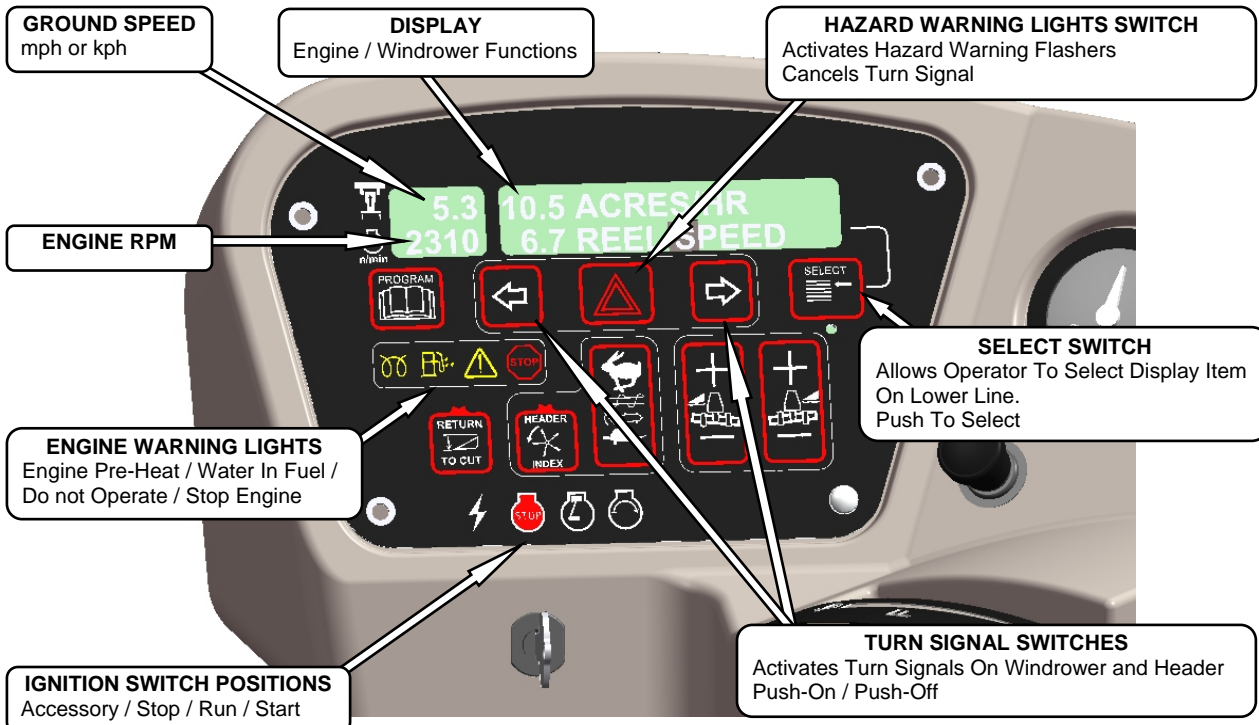

PRE-DELIVERY CHECKS

III. GAUGES AND CDM DISPLAY



- Check engine temperature gauge and fuel gauge are working.

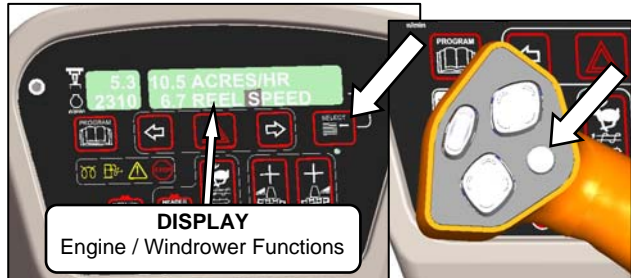

- Check CDM display is working, by pushing SELECT on CDM, or SELECT button on GSL.

IV. ELECTRICAL

- Push the SELECT button on GSL, or SELECT switch on CDM to display VOLTS. The display indicates the condition of the battery and alternator. Refer to table below.

IGNITION	ENGINE	READING	INDICATED CONDITION
On	Running	13.8 - 15.0	Normal.
		> 16.0 See Note.	Regulator Out of Adjustment.
	< 12.5 See Note.	Alternator Not Working, OR Regulator Out of Adjustment.	
	Shutdown	12.0	Battery Normal.

NOTE

Display flashes voltage reading with single loud tone. Repeats every 30 minutes until condition fixed.

V. ENGINE SPEED

- Check engine rpm on CDM.

	IDLE	MAX RPM (No Load)
M150	1100	2270 - 2330
M200	1100	2250 - 2300

VI. OPERATOR'S PRESENCE SYSTEM CHECKS

- With the windrower engine running, place the GSL in Neutral and turn the steering wheel until it locks.



CAUTION

Check to be sure all bystanders have cleared the area.

- With everyone clear of the machine, engage header drive switch.

- After header drives are running, stand up out of the seat. In approximately 5 seconds, the header should shut off.

If not, the Operator Presence System requires adjustment. See Technical Service Manual.

NOTE

To restart the header, move the header engage switch to "OFF" position, and back to the "ON" position again.

- With the engine running, position the GSL in Neutral and in N-DETENT;

- Swivel the operator's station, but do not lock into position.

- Move GSL out of N-DETENT. The engine should shut down, and the lower display will flash "LOCK SEAT BASE ---> CENTER STEERING WHEEL ---> NOT IN NEUTRAL".

- Swivel and lock the Operator's station, and the display should return to normal.

- If the engine does not shut down, the seat position switches require adjustment. Refer to Technical Service Manual.

- With the windrower moving **at less than 5 mph** (8 km/h):

- Stand up out of the seat.
- The CDM will flash "NO OPERATOR" on the upper line, and "ENGINE SHUTDOWN 5...4...3...2...1...0" on the lower line accompanied by a steady tone. At "0", the engine shuts down.

- If the engine does not shut down, the Operator Presence System requires adjustment. See Technical Service Manual.

- With the windrower moving **at more than 5 mph** (8 km/h):

- Stand up out of the seat.
- The CDM beeps once, and displays "NO OPERATOR" on the lower line.
- If not, the Operator Presence System requires adjustment. Refer to Technical Service Manual.

PRE-DELIVERY CHECKS

VII. EXTERIOR LIGHTS

- Ensure operator's seat is locked in cab-forward mode.
- Switch on FIELD lights, and check that all lights are functioning as shown below.

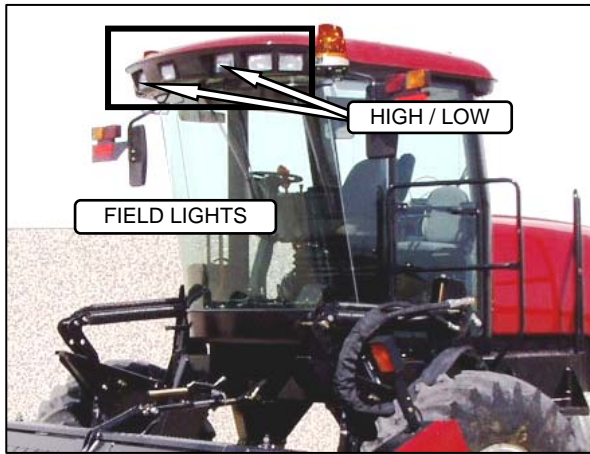

FRONT - CAB FWD

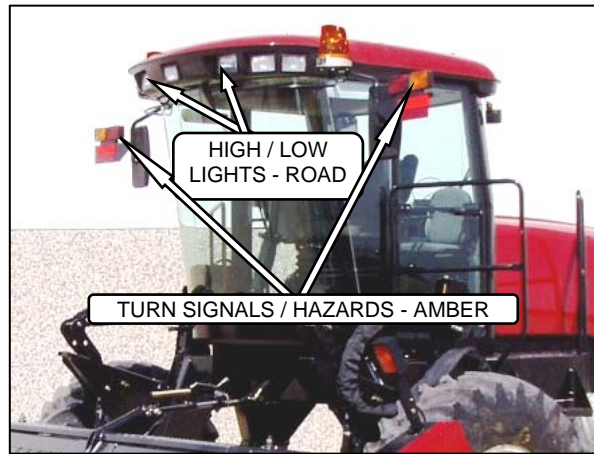

FRONT - CAB FWD

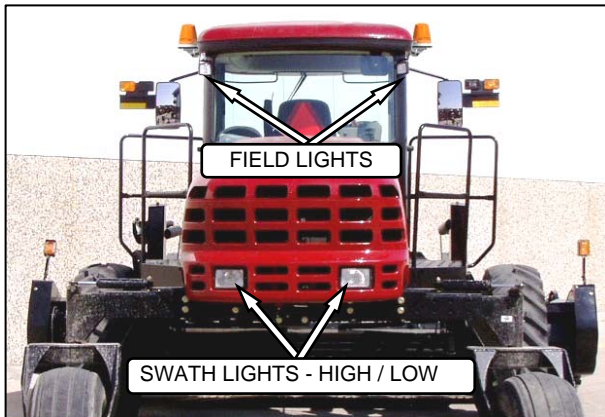

REAR - CAB FWD

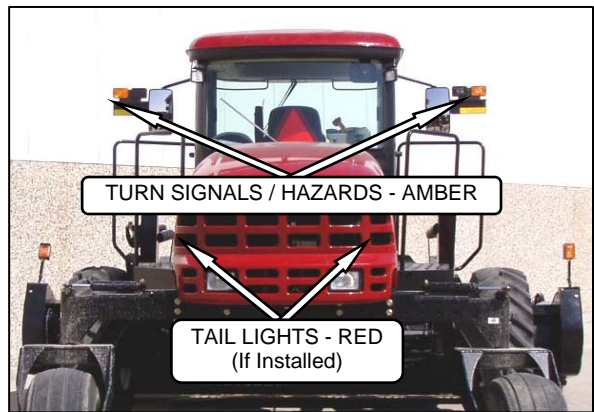

REAR - CAB FWD

- Switch on ROAD lights, and check that all lights are functioning as shown below.

- Activate HIGH/LOW switch, and check lights.
- Activate turn signals and hazard warning lights with switches on CDM, and check lights.
- Turn off lights.

(continued next page)

PRE-DELIVERY CHECKS

- g. Rotate operator's seat to engine-forward mode.
- h. Switch on ROAD lights, and check that all lights are functioning as shown below.

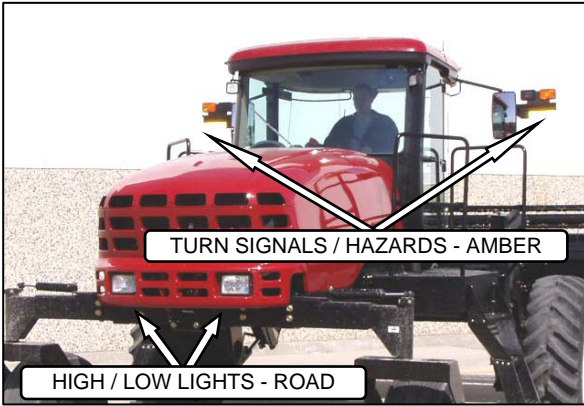

FRONT - ENG FWD

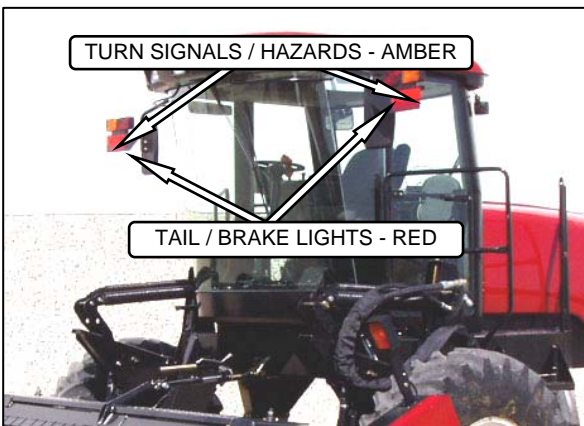

REAR - ENG FWD

- i. Activate HIGH/LOW switch, and check lights.
- j. Activate turn signals and hazard warning lights with switches on CDM, and check lights.

VIII. BEACON (IF INSTALLED)

- a. Turn on ignition, and activate beacon switch.



- b. Check beacons are working.

IX. HORN



- a. Push HORN button, and listen for horn.

PRE-DELIVERY CHECKS

X. INTERIOR LIGHTS



- Switch lights on and off with switches on each light. Interior lights only work with ROAD or FIELD light switch on.

XI. A/C AND HEATER

IMPORTANT

To distribute the oil throughout the system, perform the following steps whenever the machine is first started after storage for more than one week.

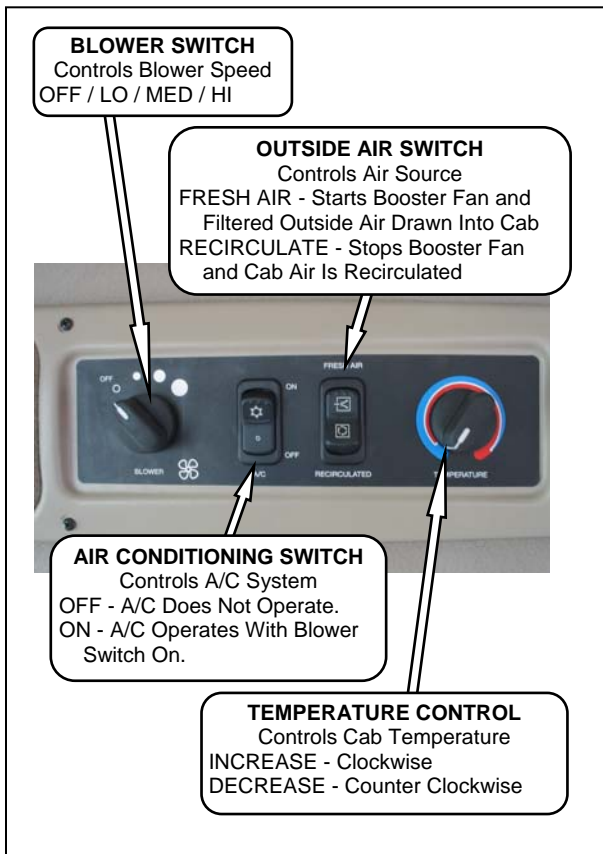

- With the engine running, turn blower switch to the first position, turn temperature control switch to maximum heating, and A/C control to "OFF".
- Click A/C switch from "OFF" to "ON" for one second, then back to "OFF" for 5 to 10 seconds. Repeat this step ten times.

K. MANUALS



- The following manuals should be stored in the manual storage case behind the operator's seat:
 - M Series Self-Propelled Windrower PARTS CATALOG. Form #169016.
 - M Series Self-Propelled Windrower OPERATOR'S MANUAL. See below:

WINDROWER	FORM NO.
MacDon	169017
Premier	169095
Westward	169087

- Engine Manual

L. CAB INTERIOR

- Remove plastic coverings from Cab Display Module and seats, after pre-delivery check is complete.

NOTES

MacDon™

MacDon Industries Ltd.

680 Moray Street
Winnipeg, Manitoba
Canada R3J 3S3
t. (204) 885-5590
f. (204) 832-7749

MacDon Inc.

10708 N. Pomona Avenue
Kansas City, Missouri
United States, 64153-1924
t. (816) 891-7313
f. (816) 891-7323

MacDon Australia Pty. Ltd.

A.C.N. 079 393 721
P.O. Box 243
Suite 3, 143 Main Street
Greensborough, Victoria
Australia 3088
t. 03 9432 9982
f. 03 9432 9972

CUSTOMERS

www.macdon.com

DEALERS

www.macdondealers.com

Trademarks of products are the marks of their
respective manufacturers and/or distributors.

Printed in Canada

M150/M200 Self-Propelled Windrower Pre-Delivery Checklist

Perform these checks and adjustments prior to delivery to your customer. The completed checklist should be retained either by the operator or the dealer.



CAUTION: Carefully follow the instructions given. Be alert for safety related messages which bring your attention to hazards and unsafe practices.

Windrower Serial Number: _____ Engine Serial Number: _____

✓	<u>ITEM</u>	<u>PAGE</u>
	Check for shipping damage or missing parts. Be sure all shipping dunnage is removed.	-
	Check for loose hardware. Tighten to required torque.	4
	Check tire air pressures and adjust as required.	40
	Check final drive hub lubricant level.	40
	Check engine coolant level and strength at reserve tank.	41
	Check air cleaner and clamps.	42
	Check hydraulic oil level and check for leaks along lines.	42
	Check fuel separator for water & foreign material. Drain and clean as necessary. Add fuel.	43
	Check gear box lubricant level.	43
	Check tension of A/C compressor belt.	43
	Check machine completely lubricated.	32
	Check neutral interlock system.	44
	Check horn operation.	49
	Check engine oil pressure indicator light at Cab Display Module.	47
START ENGINE AND RUN TO OPERATING TEMPERATURE		45
	Check Cab Display Module for operation.	47
	Check operator's presence system.	47
	Check alternator charge rate at instrument console.	47
	Check fuel gauge for operation.	47
	Check air conditioning functioning properly.	50
	Check heater functioning properly.	50
	Check instrument console gauge lights and interior lights for operation.	50
	Check maximum (no load) engine speed at Cab Display Module (M150 – 2270-2330 rpm) (M200 – 2250-2300 rpm).	47
	Check exterior lights for operation.	48
	Check hazard and signal lights for operation.	48
	Check beacons for operation (if installed).	49
	Complete the Header Pre-Delivery Checklist.	-
	Check that manuals are with the windrower.	50
	Check plastic coverings from cab interior removed.	50

Date Checked: _____

Checked by: _____